

HC CAR GO



Lighting



Electrical
Components



Workshop
Consumables

ACCESSORIES

2014/2015

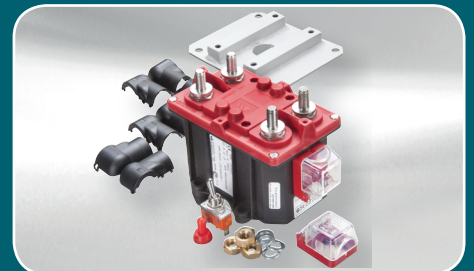



This Accessories Catalogue contains:
Lighting, Electrical Components and
Workshop Consumables.

For detailed program overview visit
www.hc-cargo.com



”Becoming an HC-CARGO supplier is not that easy. They have to fulfil a long list of preconditions and need to be DIN EN ISO 9001 certified. Last but not least they have to convince me. Together with the quality department I visit our suppliers and test them intensively before they deliver the first products.”
Martin, Purchasing Manager



ACCESSORIES LIGHTING, ELECTRICAL COMPONENTS, & WORKSHOP CONSUMABLES



For full program overview visit
www.hc-cargo.com

Edition 2014/2015





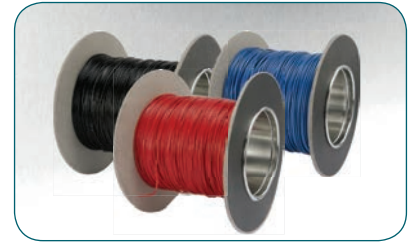

This new catalogue contains products from the HC-CARGO product areas of:



Lighting

Products such as rear multi-function lamps, rotating beacons, bulbs, reflectors and many more lighting related products. The broad program also includes work lamps and warning lights using the latest LED technology to both save energy and provide efficient light output.



Electrical Components

Products which are required at the electrical workshop or the specialist who has excelled in building complete electrical systems for the automotive customer. CCTV rear observation systems for the professional and personal user, fans and blowers, cabin heaters, electrical power management products and many more.



Workshop Consumables

Comprehensive range of components which are commonly used in the automotive workshop. This includes cables, wiring and installation material specifically for fitting electrical components and accessories. In addition to this there are a wide range of universal relays included together with specific relays for diesel applications. Furthermore, you will also find crimping tools and special tools for the purpose of dismantling and assembling starters and alternators. Other electrical tools such as multimeters and trailer connector testers and much more are also available.

In addition to the extended product program the catalogue provides a new design which gives you an easy overview of each individual product range. Moreover you'll also find more precise product information and detailed drawings on a larger number of products than before.

PAGE

<u>Acoustic Warning</u>	184
Buzzers	185
Horns	185
Reversing Alarms	184
<u>Adhesive</u>	533
Cyanoacrylate	534
Engineering	533
Quick Epoxy	534
Silicone Compound	535
<u>Assembly Parts</u>	545
Brass Olives	549
Eye Union	547
Fork Heads	546
Hollow Screws	547
Hose Nipples	546
Joints	545
Pipe Nipples	547
Retaining Rings for Shaft and Bores	548
Seals & Gaskets	545
Spring Pins	548
<u>Battery Terminals</u>	382
Brass Casting	382
For French Applications	389
Formpressed	388
Leads and Earth Straps	389
<u>Beacon Sockets</u>	34
Spare Parts	36
<u>Bulb Holder Sets</u>	149
<u>Bulb Holders</u>	146
<u>Bulbs</u>	155
Conventional	166
Electric Vehicles and Forklifts	167
Festoon	162
Flash and Penlight	167
H1 Halogen	156
H2 Halogen	156
H3 Halogen	156
H4 Halogen	157
H6W Halogen	158
H7 Halogen	158
H8 American Types	160
H9 American Types	160
H10 American Types	160
H11 American Types	160
H13 Halogen	160
H15 Halogen	158
H21W Halogen	159

PAGE

<u>Bulbs</u>	155
H27W/1 American Types	160
H27W/2 American Types	160
Halogen	168
HB1 American Types	159
HB3 A American Types	159
HB3 American Types	159
HB4 A American Types	159
HB4 American Types	159
HB5 American Types	159
High Intensity Discharge	161
Instrument Panel	164
MH6 Halogen	158
Parking and Flasher - Position	163
Spare Lamp Kits	170
Stop and Flasher - Position	169
Stop and Tail Lamps	161
Wedge Base	164
Wedge Base - Covers	167
<u>Cabin Heaters</u>	275
Accessories	278
Connectors	277
Heater Motors	277
<u>Cable & Wiring</u>	504
Alligator and Universal Clips	510
Cable Clips	504
Cable Ties	505
Cables	518
Charging Clips	507
Chassis Clips	505
Coils	526
Connectors	512
End Plug	515
Flexible Convuluted Split Tubing	513
Flexible Convuluted Tubing	512
Glands	513
Grommet	514
Heat Shrink Tubing	515
Ignition	527
Markers	527
Pipe Clips	505
Polyurethan Wire Sleeving	515
PVC Sleeveings	515
Spiral Bindings	515
Tie Mount	506
Tools	516
<u>Camera & Parking Sensors</u>	180
CCTV Rear Observation System	180
Parking Sensors	184

Care is taken to ensure the accuracy of descriptions and applications of each item, but **CAR GO** assumes no responsibility for possible errors. O.E.M. names and numbers are used for reference purposes only.
 Printed in Germany. Copyright © 2014 Holger Christiansen A/S, A Bosch Group Company

	PAGE
<u>Circuit Breakers</u>	443
ATO Blade Fuse Type	443
Maxi Blade Fuse Type	443
Panel Mount Type	443
<u>Clamps</u>	531
Ear Clips	532
Hose	531
Mini	531
Pipe	531
<u>Connectors</u>	375
3 Pole	378
4 Pole	378
Cables	379
Power	378
Tools	375
<u>Crimp Terminals</u>	336
Insulated	336
Non Insulated	339
Single Wire Seal	347
Terminal Cover	348
Tools	345
<u>Dashboard Gauges</u>	296
Ammeter	296
Fuel Gauges	297
Hour Meter	297
Oil Pressure Gauges	298
Voltmeter	297
Water Temp. Gauges	298
<u>Diesel Parts</u>	246
Bearings	246
Diesel Pump Parts	246
Feed Pumps	249
Filter Parts	252
Fuel Filters	253
Glow Plug Relays	261
Glow Plugs	259
Governor Parts	253
Injection Pipe Holders	253
Injection Pipes	253
Nozzle Holder Parts	253
Nozzles	256
Sealing Rings	257
Throttle Shafts	258
VE Pump Parts	258
VE Sundry Parts	258
VE Throttle Shafts	258

	PAGE
<u>Dry Batteries</u>	538
Alkaline	538
Battery Charger	543
Button	541
Carbon-Zink	538
Lithium	540
Rechargeable	542
<u>Fans & Blowers</u>	262
Axial Fans	269
Blower Resistors	266
Blowers	262
Fan/Heater Motors	267
<u>Fastening Parts</u>	575
Bushings	587
Cotter Pins	587
Flame Arrester	582
Hex Screws	576
Machine Screws	578
Nuts	581
Rivets	588
Tapping Screws	575
Washers	584
<u>Filters & Filter Parts</u>	241
Fuel Filters	241
Fuel Heaters	243
Spare Parts	244
Water Separator	243
<u>Forward Lighting</u>	52
Auxilliary Lamps	56
Flasher-Position Lamps Conventional	65
Flasher-Position Lamps Conventional	64
Flasher-Position Lamps Conventional	65
Flasher-Position Lamps Conventional	64
Flasher-Position Lamps Conventional	64
Flasher-Position Lamps LED	65
Headlight Inserts	54
LED Daytime Running Sets	59
Position Lamps Conventional	59
Position Lamps LED	61
Sealed Beams	55
Tractor Head Lamps	52
<u>Fuses</u>	424
ATO Blade	425
Boxes	430
Car Radio Fuses	424
Compact	428

ABBREVIATIONS:
AC=Air Condition, Alu=Aluminium, Amp=Ampere, AT=Automatic Transmission, Cat.=Catalyzer, Cyl.=Cylinder, CW=Clockwise rotation, Eur.=European application, FWD.=Front Wheel Drive, H=Hight, HD=Heavy Duty construction, HP=Horse Power, ID=Inner Diameter, kW.=Kilowatt, L=Length, LHD=Left Hand Drive, LL.=Lead Length, M=Minimum supply, MT=Manual Transmission, m.=Metre, OD=Outer Diameter, OE=Original Equipment, PS=Power Steering, RHD=Right Hand Drive, Th.=Thickness, V=Volt, w/=With, w/o=Without, W.=Width, 4WD.=Four Wheel Drive.

ACCESSORIES

PAGE

<u>Fuses</u>	424
Fuse Cards	430
Glass	424
Holders	432
HSB	428
Maxi Blade	426
Mega	426
Micro Blade	425
Midget	426
Midi	426
Mini Blade	425
Mini Blade Low Profile	425
PAL 283	427
PAL 293	426
PAL 2935	427
PAL 2938	427
PAL 294	427
PAL 295	427
PAL JCase	427
PAL Low Profile	428
Strip	428
Torpedo	424
Various	429
<u>Hand Lamps Conventional</u>	144
Accessories	146
Spare Parts	145
<u>Hand Lamps LED</u>	146
<u>Hazard Warning Lights</u>	143
LED	143
<u>Hoses & Pipes</u>	527
Hoses	527
Pipes	529
<u>Ignition Components</u>	299
Coils	299
Electronic Kits	310
Modules	304
Spark Plug Caps	311
<u>Indicator Lights</u>	440
LED	441
<u>Industrial Battery Connectors</u>	392
50 Ampere	392
80 Ampere	393
100 Ampere	393
160 Ampere	393
175 Ampere	394
250 Ampere	395
300 Ampere	396
320 Ampere	396
350 Ampere	396

PAGE

<u>Insulators</u>	349
Female Holders	349
Male Holders	350
<u>Interior Lamps Conventional</u>	123
<u>Interior Lamps Fluorescent</u>	128
Resolux 505	128
Resolux 720	128
Slim Styling	129
Spare Parts	129
Twinlights	129
<u>Interior Lamps LED</u>	124
<u>Junction Boxes</u>	499
Accessories	502
<u>Multiple Connectors</u>	351
Deutsch-Connector Accessories	368
Deutsch-Connector DT	356
Deutsch-Connector DTM	361
Deutsch-Connector DTP	366
Deutsch-Connector HD	368
Deutsch-Connector HDP	369
Holders	351
Junior-Power-Timer Accessories	374
Junior-Power-Timer-Connector	373
Junior-Timer-Connector	372
Supseal	370
<u>Oil & Grease</u>	536
Bearing Grease	536
Heat Transfer Compound	537
Lubricating Oil	537
Multi Purpose Grease	537
<u>Pen-/Torch Lights</u>	143
Pen-/Torch Lights LED	144
Torch Light Conventional	143
Torch Light LED	143
Torch Light LED/UV	144
<u>Plugs & Sockets</u>	397
Adapters - 12/24 V	401
Adapters 12 V	401
Adapters 24 V	403
Cable Kits 12 V	414
DIN and Cigarette Lighter	397
Distributor Box	404
NATO Cable Connectors	419
Trailer Coils 12 V	415
Trailer Coils 24 V	416
Trailer Plugs - 12 V	410
Trailer Plugs - 24 V	411
Trailer Plugs - 6/24 V	414
Trailer Sockets - 12 V	404
Trailer Sockets - 24 V	406

	PAGE
<u>Plugs & Sockets</u>	397
Trailer Sockets - 6/24 V	410
<u>Power Management Components</u>	189
Battery Isolators	197
Chargers	196
Load Resistors	195
Power Guard	196
Power Guard	196
Relay Boxes	192
Voltage Converters	189
Voltage Inverters	193
Voltage Reducer	195
<u>Powr-Bloks</u>	475
Accessories	477
Bridge	477
<u>Protecting Caps, Tubes & Plugs</u>	544
Protecting Caps	544
Protecting Plugs	544
Protecting Tubes	545
Rubber Boots	545
<u>Pumps & Pump Parts</u>	222
Diesel Pump Parts	239
Electrical Bilge Pumps	222
Electrical Fluid Pumps	225
Electrical Fuel Pumps	227
Electrical Water Pumps	223
Feed Pumps	233
Fuel Injection Pumps	233
<u>Radio Accessories</u>	292
Aerials	292
Capacitors	295
Loudspeaker Built-in	295
Loudspeaker in Cabinet	296
Radio Mounting Kits	296
<u>Reflectors</u>	130
Accessories	134
Container Marking	141
Miscellaneous Rear Marking	134
Rear Marking Trailers	136
Rear Marking Trucks	138
Triangles	142
Warning Triangles	141
<u>Relays</u>	447
Acoustic Warning	447
Boxes	468
Change Over - 12 V	458
Change Over - 24 V	458
Charge Relays	475
Daytime Running Lights	447
Flasher Units - 6 V	469

	PAGE
<u>Relays</u>	447
Flasher Units - 12 V	469
Flasher Units - 24 V	473
Flip Flop	462
Fuel Pumps	464
Hazard Warning Light System	468
Multi Plugs	467
Multitimer	463
Radiator Fans	464
Time Delay - 12 V	462
Time Delay - 24 V	463
Timing Devices	464
Work Relays	448
<u>Side Indicators Conventional</u>	65
Spare Parts	67
<u>Side Indicators LED</u>	67
<u>Side Marker Lamps Conventional</u>	67
Accessories	69
Spare Parts	69
<u>Side Marker Lamps LED</u>	69
Accessories	72
<u>Solenoids</u>	211
Advance Solenoids	219
Solenoid Shutdown	213
Solenoid Shutdown-Kits	211
Solenoid Stop	219
<u>Spot Lights</u>	50
Accessories	51
<u>Storage</u>	588
Metal Assortment Boxes	588
Small Part Storage Systems	588
<u>Surface Cleaning</u>	535
Abrasive Cloths	536
<u>Switches</u>	199, 478
Battery Switches	199
Control Boxes	207
Diesel Starter	209
Door & Burglar Alarm	498
Emergency Stop Switches	206
Ignition Starter	208
Ignition/Light	208
Mini Rocker	479
Multi Purpose	496
Push Button	494
Push-Pull	493
Push-Push	495
Rocker	481
Rotating	478
Spare Parts	210
Toggle	489

ACCESSORIES

PAGE

<u>Switches & Sensors - Engine Management</u>	311
Sensors	311
Switches	314
<u>Tail Lights</u>	73
Multi Function Lamps	77
Numberplate Lamps Conventional	116
Numberplate Lamps LED	117
Rear Fog Lamps Conventional	75
Rear Fog Lamps LED	76
Reversing Lamps	74
Reversing Lamps Conventional	73
Reversing Lamps LED	74
Tail Lamps Conventional	106
Tail Lamps LED	107
Tail Position Lamps Conventional	109
Tail Position Lamps LED	111
Tail-Lift Lamps Conventional	119
Tail-Lift Lamps LED	119
Trailer Lighting Sets	120
<u>Tapes</u>	532
Double Adhesive	533
Field Coil Tape	532
Insulation Tape	532
Masking	533
Textile Tape	532
Thread Seal Tape	533
<u>Tools</u>	549
A/C Parts	573
Adjustment Tools	559
Bits 1/4"	573
Bits 5/16"	575
Combi Tools	556
Dies and Taps	555
Drive Tools	559
Hose Clamp Screwdrivers	556
HSS Drills	549
Lambda Sensor Tool	557
Protecting Masks	554
Remove/Install	558
Safety Glasses	554
Soldering	550
Solenoid Coil	559
Solenoid Tools	559
Special Tools	560
Test Injection Pipes	560
Threaded Inserts	555
Tube Benders	557
Work Gloves	553
Works and Test Equipment	564
<u>Warning Lights</u>	10
Flash Lights LED	23
Light Bars Conventional	28

PAGE

<u>Warning Lights</u>	10
Light Bars LED	29
Rotating Beacons Conventional	10
Rotating Beacons LED	17
Rotating Beacons Xenon	20
<u>Wiper Systems</u>	278
Windscreen Washers	286
Wiper Arms	280
Wiper Blades	278
Wiper Motors	282
<u>Work Lamps Conventional</u>	37
<u>Work Lamps HID</u>	48
Spare Parts	49
<u>Work Lamps LED</u>	42
<u>Cross Reference List</u>	611
<u>Index</u>	649



Lighting

Edition 2014/2015



WARNING LIGHTS

ROTATING BEACONS CONVENTIONAL

170295 Rotating Beacon

Lens: HC-CARGO 170308. Motor: HC-CARGO 170505. Plastic base plate: HC-CARGO 170309.

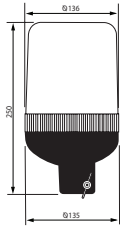

Bulb incl.: Yes
Voltage: 12

OD: 136 mm
Height: 250 mm

Bulb type: H1
Lens type: PMMA/ACRYL
Colour: Orange
Model: AEB TYPE 590
Mount.: Standard ISO A - Rod
E-approval: Yes

170296 Rotating Beacon

Lens: HC-CARGO 170308. Motor: HC-CARGO 170506. Plastic base plate: HC-CARGO 170309.

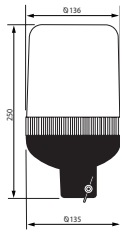

Bulb incl.: Yes
Voltage: 24

OD: 136 mm
Height: 250 mm

Bulb type: H1
Lens type: PMMA/ACRYL
Colour: Orange
Model: AEB TYPE 590
Mount.: Standard ISO A - Rod
E-approval: Yes

170435 Rotating Beacon

Lens: HC-CARGO 170308. Motor: HC-CARGO 170505.

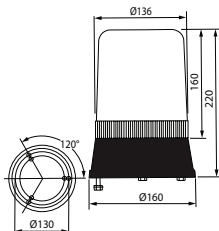

Bulb incl.: Yes
Voltage: 12

OD: 160 mm
Height: 220 mm

Bulb type: H1
Lens type: PMMA/ACRYL
Colour: Orange
Model: AEB TYPE 595
Mount.: Standard ISO B2 (and B1) - Base
E-approval: Yes

170436 Rotating Beacon

Lens: HC-CARGO 170308. Motor: HC-CARGO 170506.

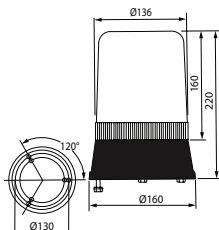

Bulb incl.: Yes
Voltage: 24

OD: 160 mm
Height: 220 mm

Bulb type: H1
Lens type: Amber dome
Colour: Orange
Model: AEB TYPE 595
Mount.: Standard ISO B2 (and B1) - Base
E-approval: Yes

170437 Rotating Beacon

Lens: HC-CARGO 170308. Motor: HC-CARGO 170505. Coil cable: length 2 m.

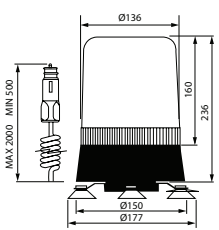

Bulb incl.: Yes
Voltage: 12

OD: 177 mm
Height: 236 mm

Bulb type: H1
Lens type: PMMA/ACRYL
Colour: Orange
Model: AEB TYPE 595 M
Mount.: 3 magnets
Base: Magnetic
Coiled cable incl.: Yes
E-approval: Yes

170438 Rotating Beacon

Lens: HC-CARGO 170308. Motor: HC-CARGO 170505. Coil cable: length 2 m.

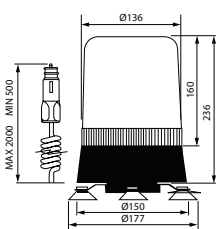

Bulb incl.: Yes
Voltage: 24

OD: 177 mm
Height: 236 mm

Bulb type: H1
Lens type: PMMA/ACRYL
Colour: Orange
Model: AEB TYPE 595 M
Mount.: 3 magnets
Base: Magnetic
Coiled cable incl.: Yes
E-approval: Yes

170490 Rotating Beacon

Lens: HC-CARGO 170492.

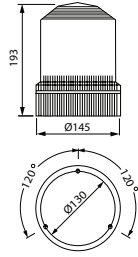

Bulb incl.: No
Voltage: 12/24

OD: 145 mm
Height: 193 mm

Bulb type: H1
Lens type: PMMA/ACRYL
Colour: Orange
Model: TYPE FT 6
Mount.: Standard ISO B2 (and B1) - Base
Tightness norm: IP 55
E-approval: Yes

170491 Rotating Beacon

Lens: HC-CARGO 170492.

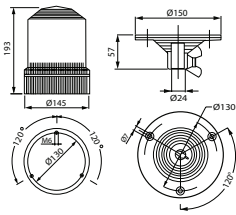

Bulb incl.: No
Voltage: 12/24

OD: 150 mm
Height: 250 mm

Bulb type: H1
Lens type: PMMA/ACRYL
Colour: Orange
Model: TYPE FT 6
Mount.: Standard ISO-DIN A or B fixing
Base: Rigid
Tightness norm: IP 55
E-approval: Yes

170540 Rotating Beacon

Lens: HC-CARGO 170543.

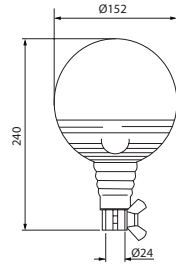

Bulb incl.: Yes
Voltage: 12

OD: 152 mm
Height: 240 mm

Bulb type: H1
Lens type: Polycarbonate
Colour: Orange
Model: Boule
Mount.: Standard ISO A - Rod
Base: Flexible
Hi impact: Yes
Waterproof: Yes
Tightness norm: IP 66
E-approval: Yes

170541 Rotating Beacon

Lens: HC-CARGO 170543.

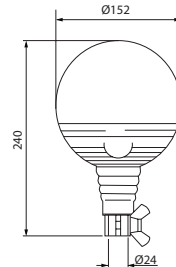

Bulb incl.: Yes
Voltage: 24

OD: 152 mm
Height: 240 mm

Bulb type: H1
Lens type: Polycarbonate
Colour: Orange
Model: Boule
Mount.: Rod (ISO-DIN A)
Base: Flexible
Hi impact: Yes
Tightness norm: IP 66
E-approval: Yes

170551 Rotating Beacon

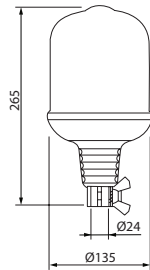

Bulb incl.: Yes
Voltage: 12

OD: 135 mm
Height: 265 mm

Bulb type: H1
Lens type: Polycarbonate
Colour: Orange
Model: TYPE GF 8.8 FLX
Mount.: Standard ISO A - Rod
Base: Flexible
Hi impact: Yes
Tightness norm: IP 54
E-approval: Yes

170598 Rotating Beacon

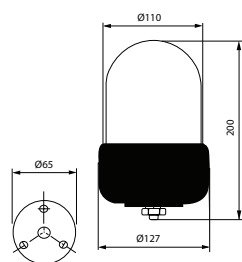

Bulb incl.: No
Voltage: 12/24

OD: 127 mm
Height: 200 mm

Bulb type: H1
Lens type: PMMA/ACRYL
Colour: Orange
Model: AEB TYPE 525
Mount.: Single bolt
E-approval: Yes

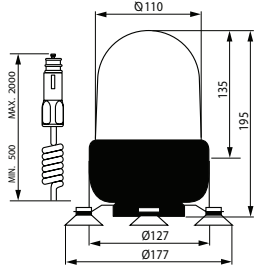
170599 Rotating Beacon

Bulb incl.: No
Voltage: 12/24

OD: 110 mm
Cable length: 2000 mm
Height: 195 mm

Bulb type: H1
Lens type: PMMA/ACRYL
Colour: Orange
Model: AEB TYPE 525 M
Mount.: 3 magnets
Base: Magnetic
Coiled cable incl.: Yes
E-approval: Yes

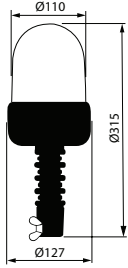
170601 Rotating Beacon

Bulb incl.: No
Voltage: 12/24

OD: 127 mm
Height: 315 mm

Bulb type: H1
Lens type: Polycarbonate
Colour: Orange
Model: AEB TYPE 530 B
Mount.: Standard ISO A - Rod
Base: Flexible
Hi impact: Yes
E-approval: Yes

170798 Rotating Beacon

Lens: HC-CARGO 170366. Motor: HC-CARGO 170505, 170506.

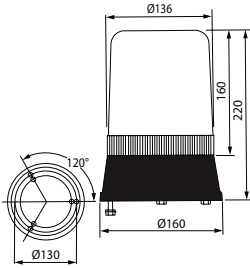

Bulb incl.: No
Voltage: 12/24

OD: 160 mm
Height: 220 mm

Bulb type: H1
Lens type: PMMA/ACRYL
Colour: Blue
Model: AEB TYPE 595
Mount.: Standard ISO B2 (and B1) - Base
E-approval: Yes

170830 Rotating Beacon

Lens: HC-CARGO 170945.

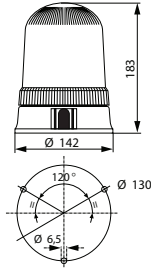

Bulb incl.: No
Voltage: 12/24

OD: 142 mm
Height: 183 mm

Bulb type: H1
Lens type: PMMA/ACRYL
Colour: Orange
Mount.: Standard ISO B2 (and B1) - Base
E-approval: Yes

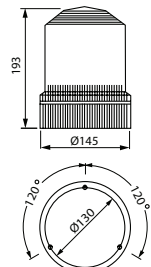
171017 Rotating Beacon

Bulb incl.: No
Voltage: 12/24

OD: 145 mm
Height: 193 mm



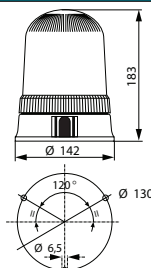





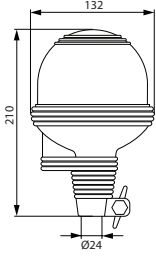

Bulb type: H1
Lens type: PMMA/ACRYL
Colour: Blue
Model: TYPE FT 6
Mount.: Standard ISO B2 (and B1) - Base
Tightness norm: IP 55
E-approval: Yes

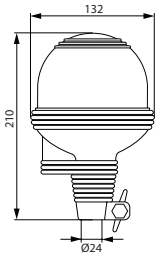
171019 Rotating Beacon

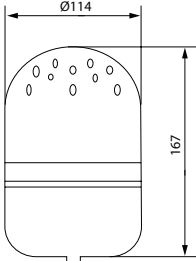
Bulb incl.: No
Voltage: 12/24

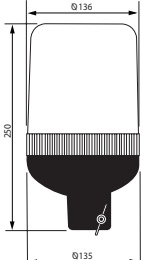
OD: 142 mm
Height: 183 mm

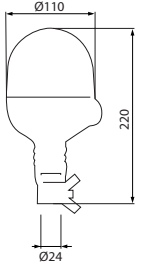
Bulb type: H1
Lens type: PMMA/ACRYL
Colour: Blue
Model: Astral
Mount.: Standard ISO B2 (and B1) - Base
E-approval: Yes

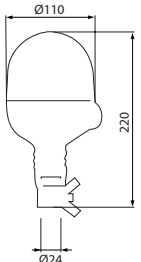
		EL. SPECIFICATIONS	DIMENSIONS	ADDITIONAL SPECIFICATIONS
171060 Rotating Beacon				
		Bulb incl.: Yes Voltage: 12	OD: 132 mm Height: 210 mm	Bulb type: H1 Lens type: Polycarbonate Colour: Orange Model: Megalux Mount.: Standard ISO A - Rod Base: Flexible Hi impact: Yes E-approval: Yes
171061 Rotating Beacon				
		Bulb incl.: Yes Voltage: 24	OD: 132 mm Height: 210 mm	Bulb type: H1 Lens type: Polycarbonate Colour: Orange Model: Megalux Mount.: Standard ISO A - Rod Base: Flexible Hi impact: Yes E-approval: Yes
171351 Rotating Beacon				
<i>Fixing bases: HC-CARGO 171349, 171354, 171355.</i>				
		Bulb incl.: Yes Voltage: 24	OD: 114 mm Height: 167 mm	Bulb type: H1 Lens type: Polycarbonate Colour: Orange Model: Rotokit Mount.: Standard ISO A/B2 (and B1) - Rod/base Hi impact: Yes Tightness norm: IP 44 E-approval: Yes
171399 Rotating Beacon				
<i>Lens: HC-CARGO 170308. Motor: HC-CARGO 170505, 170506.</i>				
		Bulb incl.: No Voltage: 12/24	OD: 136 mm Height: 250 mm	Bulb type: H1 Lens type: PMMA/ACRYL Colour: Orange Model: 590 DVO Mount.: Standard ISO A - Rod E-approval: Yes
171423 Rotating Beacon				
		Bulb incl.: Yes Voltage: 12	OD: 110 mm Height: 220 mm	Bulb type: H1 Lens type: Polycarbonate Colour: Orange Model: Microboule Mount.: Standard ISO A - Rod Base: Flexible Hi impact: Yes Tightness norm: IP 55 Approvals: CE E-approval: Yes
171424 Rotating Beacon				
		Bulb incl.: Yes Voltage: 24	OD: 110 mm Height: 220 mm	Bulb type: H1 Lens type: Polycarbonate Colour: Orange Model: Microboule Mount.: Rod (ISO-DIN A) Base: Flexible Hi impact: Yes Tightness norm: IP 55 Approvals: CE E-approval: Yes

171494 Rotating Beacon

Tested for 200 kmh. Lens: HC-CARGO 171512. 2 mtr. coiled cable. Rubber base.

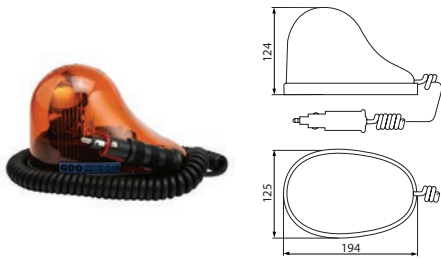

Bulb incl.: Yes
Voltage: 12

Length: 194 mm
Height: 124 mm
Width: 125 mm

Bulb type: H1
Lens type: Polycarbonate
Colour: Orange
Model: GDO
Mount.: 1 magnet
Base: Magnetic
Hi impact: Yes
Coiled cable incl.: Yes
Tightness norm: IP 55
E-approval: Yes

171577 Rotating Beacon

Lens: HC-CARGO 170945.

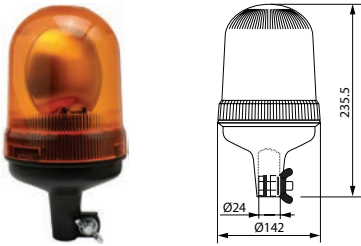

Bulb incl.: Yes
Voltage: 12

OD: 142 mm
Height: 235.5 mm

Bulb type: H1
Colour: Orange
Model: Astral
Mount.: Standard ISO A - Rod
Base: Rigid
E-approval: Yes

171587 Rotating Beacon

Lens: HC-CARGO 170945.

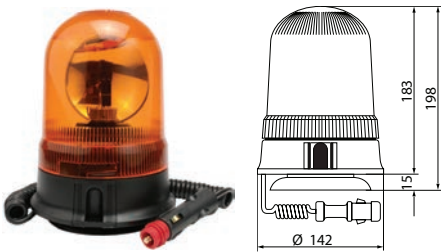

Bulb incl.: No
Voltage: 12/24

OD: 142 mm
Height: 198 mm

Bulb type: H1
Colour: Orange
Model: Astral
Mount.: 1 magnet
Coiled cable incl.: Yes
E-approval: Yes

171588 Rotating Beacon

Lens: HC-CARGO 170945.

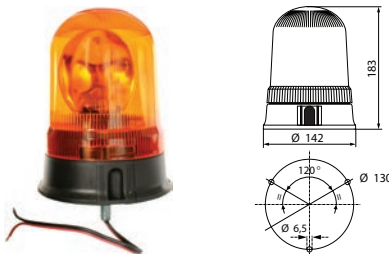

Bulb incl.: No
Voltage: 12/24

OD: 142 mm
Height: 183 mm

Bulb type: H1
Colour: Orange
Model: Astral
Mount.: Single bolt
E-approval: Yes

171705 Rotating Beacon

Solder grip multiwire splices up to 10 wires of different sizes and can be combined w/ fluxed solder and heat shrinkable thermoplastic sleeve.

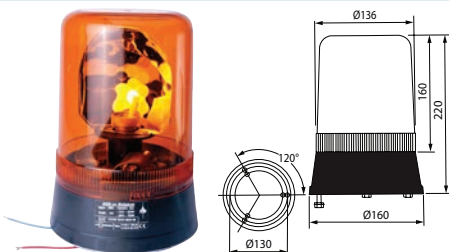

Bulb incl.: No
Voltage: 12/24

OD: 160 mm
Height: 220 mm

Bulb type: H1
Lens type: PMMA/ACRYL
Colour: Orange
Model: AEB TYPE 595
Mount.: Plan (ISO-DIN B)
E-approval: Yes

171793 Rotating Beacon

Lens: HC-CARGO 170945.

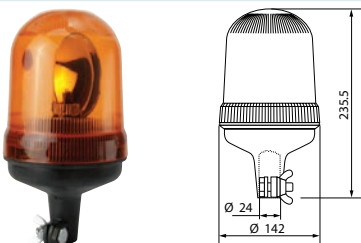

Bulb incl.: No
Voltage: 12/24

OD: 142 mm
Height: 235.5 mm

Bulb type: H1
Lens type: Polycarbonate
Colour: Orange
Model: Astral flex
Mount.: Standard ISO A - Rod
Base: Flexible
Hi impact: Yes
E-approval: Yes

SPARE PARTS		
170308 Dome Servicing: HC-CARGO 170295, 170296, 170435, 170436, 170437, 170438, 170798, 171399		
	Height: 160 mm Width: 136 mm	Lens type: PMMA/ACRYL Colour: Orange Model: TYPE 590/595/595M
170309 Base Plate Servicing: HC-CARGO 170295, 170296, 170435, 170436, 170437, 170438, 170798, 171399		
	Height: 90 mm Width: 135 mm	Model: TYPE 590/595/595M
170366 Dome Servicing: HC-CARGO 170295, 170296, 170435, 170436, 170437, 170438, 170798, 171399		
	Height: 160 mm Width: 136 mm	Lens type: PMMA/ACRYL Colour: Blue Model: TYPE 590/595/595M
170492 Dome Servicing: HC-CARGO 170490, 170491		
	Height: 151 mm Width: 134 mm	Lens type: PMMA/ACRYL Colour: Orange Model: TYPE FT 6
170505 Beacon Motor Servicing: HC-CARGO 170295, 170296, 170435, 170436, 170437, 170438, 170798, 171399		
	Voltage: 12 Height: 65 mm Width: 30 mm	Model: TYPE 590/595/595M
170506 Beacon Motor Servicing: HC-CARGO 170295, 170296, 170435, 170436, 170437, 170438, 170798, 171399		
	Voltage: 24 Height: 65 mm Width: 30 mm	Model: TYPE 590/595/595M

ACCESSORIES - Lighting

O.E.M. names and numbers are used for reference purposes only.

	EL. SPECIFICATIONS	DIMENSIONS	ADDITIONAL SPECIFICATIONS
170528 Base Plate Servicing: HC-CARGO 170491, 170490, 170650, 170651, 171498, 170680			
		Height: 58 mm Width: 150 mm	Model: TYPE FT 6 Mount.: Standard ISO A - Rod
170543 Dome Servicing: HC-CARGO 170540, 170541			
		Height: 120.5 mm Width: 152.5 mm	Lens type: Polycarbonate Colour: Orange Model: Boule Hi impact: Yes
170945 Dome Servicing: HC-CARGO 170830, 171019, 171577, 171587, 171588, 171793			
		Height: 148 mm Width: 127 mm	Lens type: PMMA/ACRYL Colour: Orange Model: Astral E-approval: Yes
ACCESSORIES			
170525 Beacon Socket Servicing: HC-CARGO 170490, 171017			
		Cable length: 2000 mm	Model: TYPE FT 6 Mount.: 3 magnets Base: Magnetic Coiled cable incl.: Yes Tightness norm: IP 55
171349 Beacon Base Servicing: HC-CARGO 171351			
			Model: Rotokit Mount.: Standard ISO B2 (and B1) - Base
171354 Beacon Base Servicing: HC-CARGO 171351			
<i>w/ multi plug that fits the rotokit beacon.</i>			
		Cable length: 455/3500 mm	Model: Rotokit Mount.: 3 magnets Base: Magnetic Coiled cable incl.: Yes
171355 Beacon Base Servicing: HC-CARGO 171351			
<i>w/ multi plug that fits the rotokit beacon.</i>			
		Cable length: 455/3500 mm	Model: Rotokit Mount.: 1 magnet Coiled cable incl.: Yes

ROTATING BEACONS LED			
171673 LED Beacon			
	Voltage: 11-110	OD: 98 mm Height: 130 mm	Bulb type: LED Lens type: Polycarbonate Flash rate: 45 min. Colour: Orange Model: LED Mount.: Plan Hi impact: Yes Waterproof: Yes Tightness norm: IP 66 Approvals: SAE/CE E-approval: No
171674 LED Beacon			
	Voltage: 11-110	OD: 130 mm Height: 98 mm	Bulb type: LED Lens type: Polycarbonate Flash rate: 45 min. Colour: Orange Model: LED Mount.: Plan Hi impact: Yes Waterproof: Yes Tightness norm: IP 66 Approvals: SAE/CE E-approval: No
171763 LED Beacon			
	Voltage: 12/24 Amp: 1.7/0.8	OD: 120 mm Height: 121 mm	Bulb type: LED Lens type: Polycarbonate Flash rate: 130 min. Colour: Orange Material: Aluminium Mount.: Standard ISO A - Rod Hi impact: Yes Waterproof: Yes Tightness norm: IP 66 E-approval: Yes
171764 LED Beacon			
	Voltage: 12/24	OD: 148 mm Height: 74 mm	Bulb type: LED Lens type: Polycarbonate Flash rate: 130 min. Colour: Orange Material: Aluminium Mount.: Standard ISO B2 (and B1) - Base Hi impact: Yes Waterproof: Yes Tightness norm: IP 66 Approvals: ECE-R65 E-approval: Yes
171918 LED Beacon			
	Voltage: 12-24 Amp: 1.2/2.9 Watt: 37	OD: 142 mm Height: 128 mm	Bulb type: LED Lens type: Polycarbonate Colour: Orange Material: Aluminium Model: LED Mount.: Plan Flash patterns: 11 Hi impact: Yes Waterproof: Yes Approvals: SAE/ECE-R65 E-approval: Yes

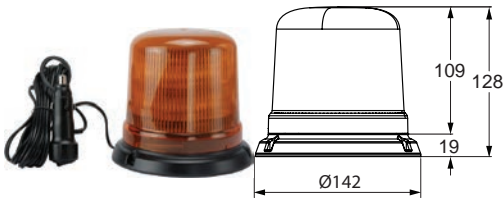
171919 LED Beacon

Voltage: 12-24
Amp: 1.2/2.9
Watt: 37

OD: 142 mm
Cable length: 3000 mm
Height: 128 mm

Bulb type: LED
Lens type: Polycarbonate
Colour: Orange
Material: Aluminium
Model: LED
Mount.: Lighter Socket
Base: Magnetic
Flash patterns: 11
Hi impact: Yes
Waterproof: Yes
Approvals: SAE/ECE-R65
E-approval: Yes

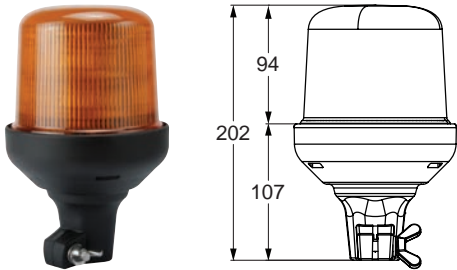
171920 LED Beacon

Voltage: 12-24
Amp: 1.2/2.9
Watt: 37

OD: 130 mm
Height: 202 mm

Bulb type: LED
Lens type: Polycarbonate
Colour: Orange
Material: Aluminium
Model: LED
Mount.: Standard ISO A - Rod
Flash patterns: 11
Hi impact: Yes
Coiled cable incl.: No
Waterproof: Yes
Approvals: SAE/ECE-R65
E-approval: Yes

171921 LED Beacon

Voltage: 12-24
Amp: 1.2/2.9
Watt: 37

OD: 142 mm
Height: 128 mm

Bulb type: LED
Lens type: Polycarbonate
Colour: Blue
Material: Aluminium
Model: LED
Mount.: Plan
Flash patterns: 11
Hi impact: Yes
Coiled cable incl.: No
Waterproof: Yes
Approvals: SAE/ECE-R65
E-approval: Yes

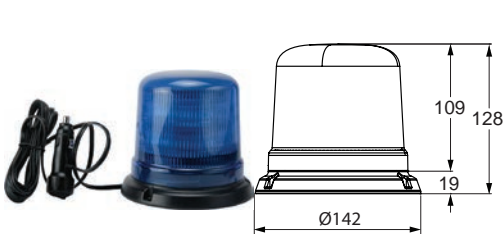
171922 LED Beacon

Voltage: 12-24
Amp: 1.2/2.9
Watt: 37

OD: 142 mm
Cable length: 3000 mm
Height: 128 mm

Bulb type: LED
Lens type: Polycarbonate
Colour: Blue
Material: Aluminium
Model: LED
Mount.: 3 magnets
Flash patterns: 11
Hi impact: Yes
Coiled cable incl.: Yes
Waterproof: Yes
Approvals: SAE/ECE-R65
E-approval: Yes

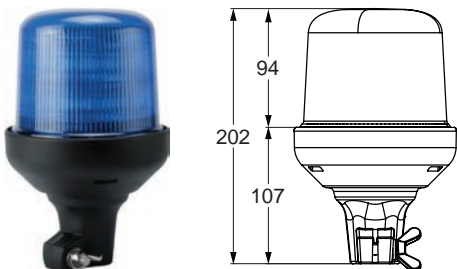
171923 LED Beacon

Voltage: 12-24
Amp: 1.2/2.9
Watt: 37

OD: 130 mm
Height: 202 mm



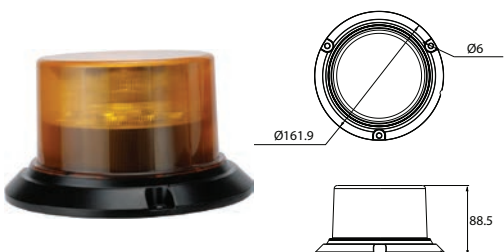

Bulb type: LED
Lens type: Polycarbonate
Colour: Blue
Material: Aluminium
Model: LED
Mount.: Standard ISO A - Rod
Flash patterns: 11
Hi impact: Yes
Waterproof: Yes
Approvals: SAE/ECE-R65
E-approval: Yes

171931 LED Beacon

Voltage: 12-36
Watt: 35/44

OD: 161.9 mm
Height: 88.5 mm

Bulb type: LED
Colour: Orange
Mount.: Plan
Waterproof: Yes
Tightness norm: IP 67
Approvals: SAE/ECE-R65
E-approval: Yes

	EL. SPECIFICATIONS	DIMENSIONS	ADDITIONAL SPECIFICATIONS	
171957 LED Beacon			Voltage: 10-100 Amp: 0.1 OD: 77 mm Height: 45 mm	Bulb type: LED Lens type: Polycarbonate Colour: Orange Material: Polycarbonate Mount.: Plan Flash patterns: 4 Hi impact: Yes Tightness norm: IP 67 Approvals: CE
171971 LED Beacon			Voltage: 12-24 Watt: 15 OD: 143 mm Height: 86.4 mm	Bulb type: 8 LED Colour: Orange Material: Polycarbonate Model: LED Mount.: Plan Tightness norm: IP 66 Approvals: CE/EMC/ECE-R65 E-approval: Yes
171972 LED Beacon			Voltage: 12-24 Watt: 15 OD: 121 mm Height: 145 mm	Bulb type: 6 LED Colour: Orange Material: Polycarbonate Model: LED Mount.: Rod (ISO-DIN A) Hi impact: Yes Tightness norm: IP 66 Approvals: CE/EMC/ECE-R65 E-approval: Yes
171973 LED Beacon			Voltage: 12-24 Watt: 15 OD: 126 mm Cable length: 2000 mm Height: 115 mm	Bulb type: 8 LED Colour: Orange Material: Polycarbonate Model: LED Mount.: Lighter Socket Base: Magnetic/vacuum Hi impact: Yes Coiled cable incl.: Yes Tightness norm: IP 66 Approvals: CE/EMC/ECE-R65 E-approval: Yes
SPARE PARTS				
171941 Lens	Servicing: HC-CARGO 171918, 171919, 171920			
			Lens type: Polycarbonate Colour: Orange	
171942 Lens	Servicing: HC-CARGO 171921, 171922, 171923			
			Lens type: Polycarbonate Colour: Blue	

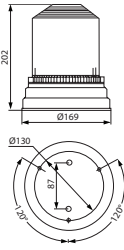
ROTATING BEACONS XENON
170650 Xenon Beacon

Bulb incl.: Yes
Voltage: 12
Amp: 1.5

OD: 169 mm
Height: 202 mm

Bulb type: LX10J
Lens type: Polycarbonate
Colour: Orange
Model: XENON FT6 AG ELECTRONIC
Mount.: Standard ISO B2 (and B1) - Base
Hi impact: Yes
Tightness norm: IP 55
E-approval: Yes

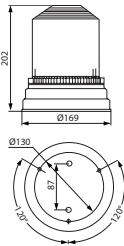
170651 Xenon Beacon

Bulb incl.: Yes
Voltage: 24
Amp: 1.5

OD: 169 mm
Height: 202 mm

Bulb type: LX10J
Lens type: PMMA/ACRYL
Colour: Orange
Model: XENON FT6 AG ELECTRONIC
Mount.: Standard ISO B2 (and B1) - Base
Tightness norm: IP 55
E-approval: Yes

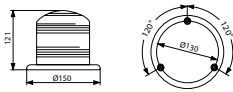
170680 Xenon Beacon

Bulb incl.: Yes
Voltage: 10-100
Amp: 200/50
mAmpere

OD: 150 mm
Height: 121 mm
Width: 150 mm

Bulb type: LX1J
Lens type: Polycarbonate
Colour: Orange
Material: Polycarbonate
Model: FLASH ELEV
Mount.: Standard ISO B2 (and B1) - Base
Base: Rigid
Hi impact: Yes
Tightness norm: IP 54
Approvals: CE/EMC

171005 Xenon Beacon

w/ Xenon tube. Lens: HC-CARGO 171590.

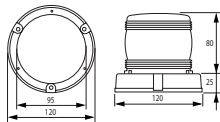

Bulb incl.: Yes
Voltage: 10-100

OD: 120 mm
Height: 105 mm

Bulb type: LX10J
Lens type: PMMA/ACRYL
Colour: Orange
Model: TYPE TRASPOT XENON
Mount.: Standard ISO B2 (and B1) - Base
Approvals: CE/EMC

171495 Xenon Beacon

Tested for 200 kmh. Lens: HC-CARGO 171512.

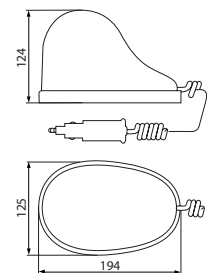

Bulb incl.: Yes
Voltage: 12
Amp: 1.5

Length: 194 mm
Height: 124 mm
Width: 125 mm

Bulb type: LX8J
Lens type: Polycarbonate
Colour: Orange
Material: Rubber
Model: GDO FLASH
Mount.: 1 magnet
Base: Magnetic
Hi impact: Yes
Coiled cable incl.: Yes
Tightness norm: IP 55
Approvals: CE
E-approval: Yes

171497 Xenon Beacon

Tested for 200 kmh.

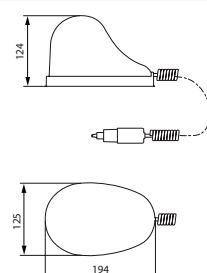

Bulb incl.: Yes
Voltage: 12
Amp: 1.5

Length: 194 mm
Height: 124 mm
Width: 125 mm

Bulb type: LX8J
Lens type: Polycarbonate
Colour: Blue
Material: Rubber
Model: GDO FLASH
Mount.: 1 magnet
Base: Magnetic
Hi impact: Yes
Coiled cable incl.: Yes
Tightness norm: IP 55
Approvals: CE
E-approval: Yes

171498 Xenon Beacon

w/ built-in audible signal.

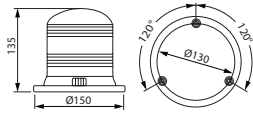

Bulb incl.: Yes
Voltage: 10-100
Amp: 200/50 mAmp

OD: 150 mm
Height: 135 mm

Bulb type: LX1J
Lens type: Polycarbonate
Colour: Orange
Model: FLASH ELEV SL
Mount.: Standard ISO B2 (and B1) - Base
Hi impact: Yes
Tightness norm: IP 20

171505 Xenon Beacon

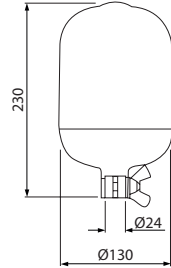

Bulb incl.: Yes
Voltage: 12
Amp: 3

OD: 130 mm
Height: 230 mm

Bulb type: LX10J
Lens type: Polycarbonate
Colour: Orange
Model: XENON GF 8.8 FLASH
Mount.: Plan (ISO-DIN B)
Base: Rigid
Hi impact: Yes
Tightness norm: IP 44
Approvals: CE
E-approval: Yes

171540 Xenon Beacon

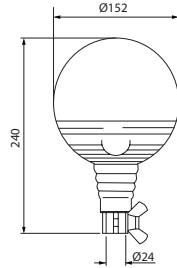

Bulb incl.: Yes
Voltage: 12
Amp: 1.5

OD: 152 mm
Height: 240 mm

Bulb type: LX8J
Lens type: Polycarbonate
Colour: Orange
Model: BOULE FLASH
Mount.: Standard ISO A - Rod
Base: Flexible
Hi impact: Yes
Tightness norm: IP 66
E-approval: Yes

171541 Xenon Beacon

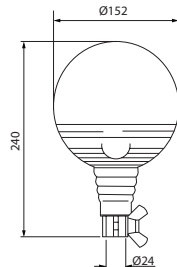

Bulb incl.: Yes
Voltage: 24
Amp: 1.5

OD: 152 mm
Height: 240 mm

Bulb type: LX8J
Lens type: Polycarbonate
Colour: Orange
Model: BOULE FLASH
Mount.: Standard ISO A - Rod
Base: Flexible
Hi impact: Yes
Tightness norm: IP 66
E-approval: Yes

171561 Xenon Beacon

w/ Xenon tube. Lens: HC-CARGO 171590.

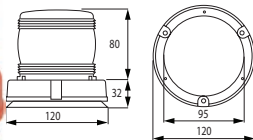

Voltage: 10-100

OD: 120 mm
Height: 112 mm

Lens type: PMMA/ACRYL
Colour: Orange
Model: Type TRASPOT
Mount.: Standard ISO B2 (and B1) - Base
Base: Magnetic
Coiled cable incl.: Yes
Approvals: CE/EMC

171614 Xenon Beacon

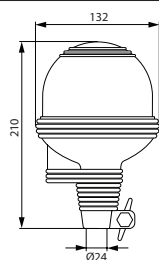

Bulb incl.: Yes
Voltage: 10-30

OD: 132 mm
Height: 210 mm

Bulb type: LX10J
Lens type: Polycarbonate
Colour: Orange
Model: Xenon
Mount.: Standard ISO A - Rod
Hi impact: Yes
E-approval: Yes

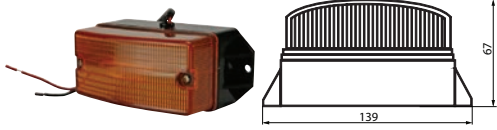
171708 Xenon Beacon

Bulb incl.: Yes
Voltage: 11-120
Amp: 0.2

Length: 139 mm
Height: 67 mm

Bulb type: Xenon
Lens type: Polycarbonate
Flash rate: 72 min.
Colour: Orange
Mount.: Plan
Hi impact: Yes
Waterproof: Yes
Approvals: CE

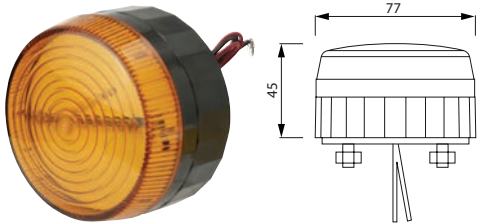
171798 Xenon Beacon

Voltage: 10-100
Watt: 5

OD: 77 mm
Height: 45 mm
Dist. mount. holes:
45 mm
Width: 77 mm

Bulb type: Xenon
Lens type: Polycarbonate
Flash rate: 75 min.
Colour: Orange
Material: Polycarbonate
Mount.: Plan
Hi impact: Yes
Tightness norm: IP 67
Approvals: CE

SPARE PARTS
170654 Xenon Bulb

Servicing: HC-CARGO 170650, 170651, 171505, 171005



Voltage: 12/24
Watt: 16

Bulb type: LX10J
Model: XENON FT6 /FLX ELECTRONIC

171376 Xenon Bulb

Servicing: HC-CARGO 171498, 170680



Bulb type: LX1J
Model: FLASH ELEV

171590 Dome

Servicing: HC-CARGO 171005, 171561



Lens type: PMMA/ACRYL
Colour: Orange
Model: TRASPORT XENON

ACCESSORIES
170525 Beacon Socket

Servicing: HC-CARGO 170490, 171017



OD: 208 mm
Height: 28 mm
Cable length: 2000 mm

Model: TYPE FT 6
Mount.: 3 magnets
Base: Magnetic
Coiled cable incl.: Yes
Tightness norm: IP 55

170528 Base Plate

Servicing: HC-CARGO 170491, 170490, 170650, 170651, 171498, 170680

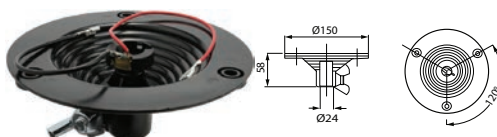

Height: 58 mm
Width: 150 mm

Model: TYPE FT 6
Mount.: Standard ISO A - Rod

170653 Beacon Socket

Servicing: HC-CARGO 170650, 170651, 171466

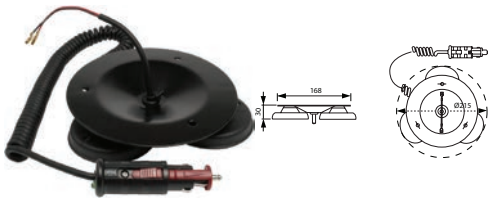

Height: 30 mm
Cable length: 2000 mm
Width: 168 mm

Mount.: 3 magnets
Base: Magnetic
Coiled cable incl.: Yes
Tightness norm: IP 55
E-approval: Yes

FLASH LIGHTS LED

171642 LED Flash, white

Multi-module synchronization. Bracket: HC-CARGO 171657. Rubber adapter for flush mount: HC-CARGO 171728.

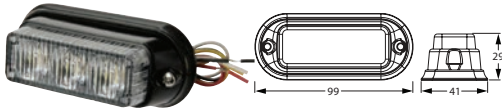

Voltage: 12/24

Length: 99 mm
Height: 29 mm
Width: 41 mm

Bulb type: LED
Colour: White
Model: 3 LED
Flash patterns: 12
Waterproof: Yes
Approvals: CE/EMC

171644 LED Flash, blue

Multi-module synchronization. Bracket: HC-CARGO 171657. Rubber adapter for flush mount: HC-CARGO 171728.

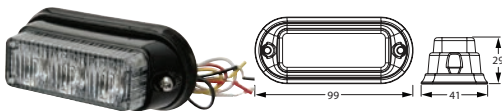

Voltage: 12/24

Length: 99 mm
Height: 29 mm
Width: 41 mm

Bulb type: LED
Colour: Blue
Model: 3 LED
Flash patterns: 12
Waterproof: Yes
Approvals: CE/EMC

171646 LED Flash, white

Multi-module synchronization. Bracket: HC-CARGO 171658. Rubber adapter for flush mount: HC-CARGO 171675.

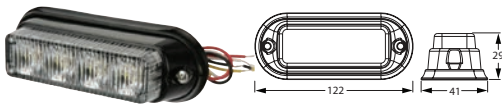

Voltage: 12/24

Length: 122 mm
Height: 29 mm
Width: 41 mm

Bulb type: LED
Colour: White
Model: 4 LED
Flash patterns: 19
Waterproof: Yes
Approvals: CE/EMC

171648 LED Flash, blue

Multi-module synchronization. Bracket: HC-CARGO 171658. Rubber adapter for flush mount: HC-CARGO 171675.

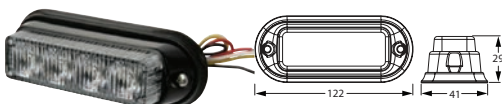

Voltage: 12/24

Length: 122 mm
Height: 29 mm
Width: 41 mm

Bulb type: LED
Colour: Blue
Model: 4 LED
Flash patterns: 19
Waterproof: Yes
Approvals: CE/EMC

171650 LED Flash, white

Multi-module synchronization. Bracket: HC-CARGO 171659.

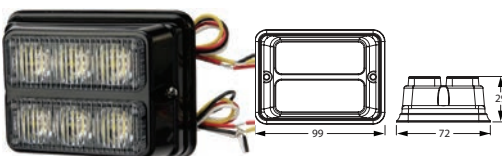

Voltage: 12/24

Length: 99 mm
Height: 29 mm
Width: 72 mm

Bulb type: LED
Colour: White
Model: 2x3 LED
Flash patterns: 12
Waterproof: Yes
Approvals: CE
E-approval: Yes

171651 LED Flash, red

Multi-module synchronization. Bracket: HC-CARGO 171659.

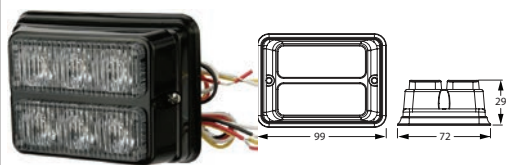

Voltage: 12/24

 Length: 99 mm
 Height: 29 mm
 Width: 72 mm

 Bulb type: LED
 Colour: Red
 Model: 2x3 LED
 Flash patterns: 12
 Waterproof: Yes
 Approvals: CE
 E-approval: Yes

171652 LED Flash, blue

Multi-module synchronization. Bracket: HC-CARGO 171659.

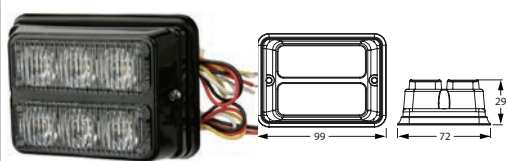

Voltage: 12/24

 Length: 99 mm
 Height: 29 mm
 Width: 72 mm

 Bulb type: LED
 Colour: Blue
 Model: 2x3 LED
 Flash patterns: 12
 Waterproof: Yes
 Approvals: CE
 E-approval: Yes

171654 LED Flash, white

Multi-module synchronization. Bracket: HC-CARGO 171660.

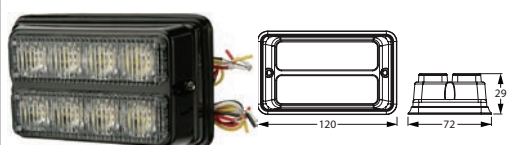

Voltage: 12/24

 Length: 120 mm
 Height: 29 mm
 Width: 72 mm

 Bulb type: LED
 Colour: White
 Model: 2x4 LED
 Flash patterns: 19
 Waterproof: Yes
 Approvals: CE
 E-approval: Yes

171661 LED Flash, amber

Multi-module synchronization. Bracket: HC-CARGO 171663.

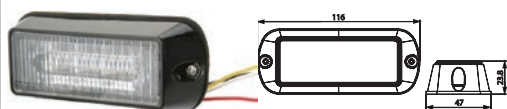

Voltage: 12/24

 Length: 116 mm
 Height: 23.8 mm
 Width: 47 mm

 Bulb type: LED
 Lens type: Frosted
 Colour: Orange
 Model: 4 LED
 Flash patterns: 12
 Waterproof: Yes
 Approvals: SAE/CE

171662 LED Flash, amber

Multi-module synchronization. Bracket: HC-CARGO 171664.

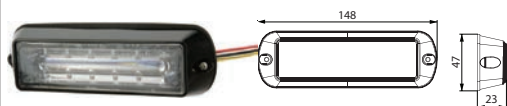

Voltage: 12/24

 Length: 148 mm
 Height: 23 mm
 Width: 47 mm

 Bulb type: LED
 Lens type: Transparent
 Colour: Orange
 Model: 6 LED
 Flash patterns: 19
 Waterproof: Yes
 Approvals: SAE/CE

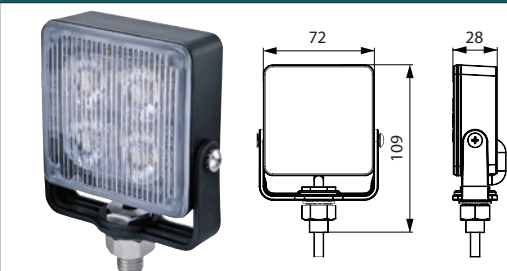
171746 LED Flash, amber

Voltage: 12/24

 Length: 109 mm
 Height: 28 mm
 Width: 72 mm

 Bulb type: LED
 Lens type: Transparent
 Colour: Orange
 Material: Cast aluminum
 Hi impact: Yes
 Coiled cable incl.: No
 Waterproof: Yes
 Approvals: CE

171765 LED Flash, amber

Rubber adapter for flush mount: HC-CARGO 171766.

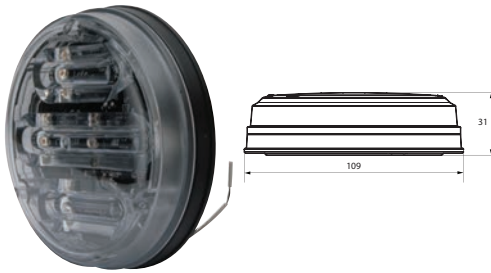

Voltage: 12/24

OD: 109 mm
Height: 31 mm

Bulb type: 10 LED
Lens type: Polycarbonate
Colour: Orange
Mount.: Plan
Hi impact: Yes
Waterproof: Yes

171813 LED Flash, blue

Fits w/ rubber adapter for flush mount: HC-CARGO 171817.

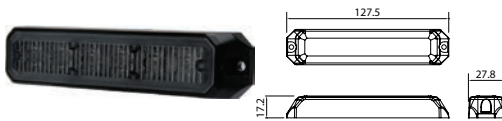

Voltage: 12/24

Length: 127.5 mm
Height: 17.2 mm
Width: 27.8 mm

Bulb type: LED
Flash rate: 5 min.
Colour: Blue
Model: 6 LED
Waterproof: Yes
Approvals: SAE/ECE-R65
E-approval: Yes

171814 LED Flash, amber

Fits w/ rubber adapter for flush mount: HC-CARGO 171817.

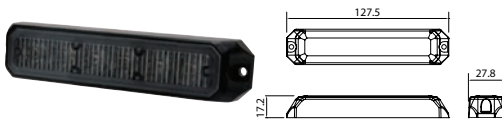

Voltage: 12/24

Length: 127.5 mm
Height: 17.2 mm
Width: 27.8 mm

Bulb type: LED
Colour: Yellow
Model: 6 LED
Flash patterns: 5
Waterproof: Yes
Approvals: SAE/ECE-R65
E-approval: Yes

171815 LED Flash, yellow

For HC-CARGO 171816.

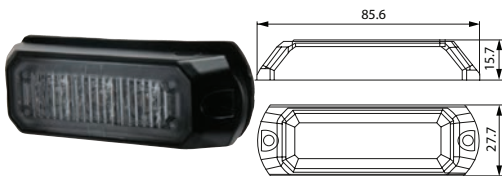

Voltage: 12/24

Length: 85.6 mm
Height: 15.7 mm
Width: 27.7 mm

Bulb type: LED
Colour: Orange
Model: 3 LED
Flash patterns: 12
Waterproof: Yes
Approvals: SAE/ECE-R65
E-approval: Yes

171904 LED Flash, amber

Multi-module synchronization. Bracket: HC-CARGO 171658. Rubber adapter for flush mount: HC-CARGO 171675.

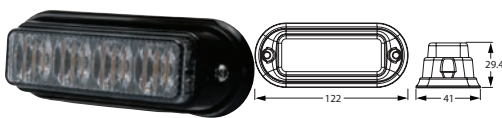

Voltage: 12-24

Length: 122 mm
Height: 29.4 mm
Width: 41 mm

Bulb type: LED
Colour: Orange
Model: 4 LED
Flash patterns: 19
Waterproof: Yes
Approvals: SAE/ECE-R65
E-approval: Yes

171905 LED Flash, amber

Multi-module synchronization. Bracket: HC-CARGO 171657. Rubber adapter for flush mount: HC-CARGO 171728.

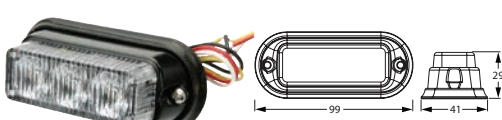

Voltage: 12-24

Length: 99 mm
Height: 29 mm
Width: 41 mm

Bulb type: LED
Colour: Orange
Model: 3 LED
Flash patterns: 12
Waterproof: Yes
Approvals: SAE/ECE-R65
E-approval: Yes

171906 LED Flash, amber

Multi-module synchronization. Bracket: HC-CARGO 171657. Rubber adapter for flush mount: HC-CARGO 171907.

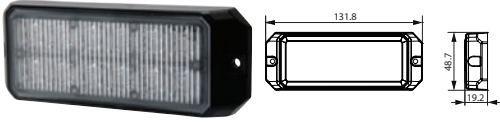

Voltage: 12-24

Length: 131.8 mm
Height: 48.7 mm
Width: 19.2 mm

Bulb type: LED
Colour: Orange
Model: 12 LED
Flash patterns: 25
Waterproof: Yes
Approvals: SAE/ECE-R65
E-approval: Yes

171926 LED Flash, amber

Fits w/ rubber adapter for flush mount: HC-CARGO 171817.



Voltage: 12-24

Length: 127.5 mm
Cable length: 2000 mm
Height: 17.2 mm
Width: 27.8 mm

Bulb type: LED
Colour: Yellow
Model: 6 LED
Mount.: 3 m ADR Cable
Waterproof: Yes
Approvals: SAE/ECE-R65
E-approval: Yes

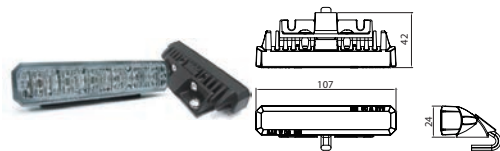
171933 LED Flash, amber

Voltage: 11-30

Length: 107 mm
Height: 24 mm
Width: 42 mm

Bulb type: LED
Colour: Yellow
Model: 6 LED
Mount.: Plan
Flash patterns: 5
Waterproof: Yes
Approvals: SAE/ECE-R65
E-approval: Yes

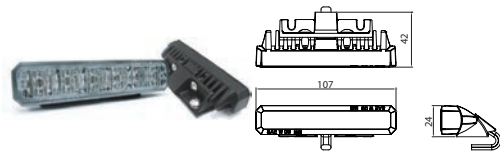
171934 LED Flash, blue

Voltage: 11-30

Length: 107 mm
Height: 24 mm
Width: 42 mm

Bulb type: LED
Colour: Blue
Model: 6 LED
Mount.: Plan
Flash patterns: 5
Waterproof: Yes
Approvals: SAE/ECE-R65
E-approval: Yes

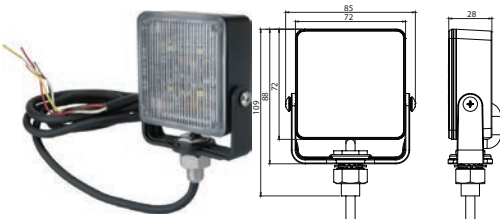
171943 LED Flash, white

Voltage: 12/24
Amp: 0.27-0.13
Watt: 3.5

Length: 109 mm
Cable length: 1200 mm
Height: 28 mm
Width: 72 mm

Bulb type: LED
Lens type: Transparent
Colour: White
Material: Aluminium
Hi impact: Yes
Coiled cable incl.: No
Waterproof: Yes
Approvals: SAE/CE

ACCESSORIES
171657 Mounting Bracket

Servicing: HC-CARGO 171641, 171642, 171644

Angled. For single head.



Length: 100 mm
Thickness: 24 mm
Width: 55 mm

EL. SPECIFICATIONS	DIMENSIONS	ADDITIONAL SPECIFICATIONS
<p>171658 Mounting Bracket <i>Angled. For single head.</i></p> 	<p>Length: 123 mm Thickness: 55 mm Width: 24 mm</p>	<p>Servicing: HC-CARGO 171646, 171648</p>
<p>171659 Mounting Bracket <i>Angled. For double head.</i></p> 	<p>Length: 102 mm Thickness: 24 mm Width: 100 mm</p>	<p>Servicing: HC-CARGO 171650, 171651, 171652</p>
<p>171660 Mounting Bracket <i>Angled. For double head.</i></p> 	<p>Length: 123 mm Thickness: 100 mm Width: 24 mm</p>	<p>Servicing: HC-CARGO 171654</p>
<p>171663 Mounting Bracket <i>Angled 100°.</i></p> 	<p>Length: 153 mm Thickness: 55 mm Width: 25 mm</p>	<p>Servicing: HC-CARGO 171661</p>
<p>171664 Mounting Bracket <i>Adjustable.</i></p> 	<p>Length: 156 mm Thickness: 42 mm Width: 30 mm</p>	<p>Servicing: HC-CARGO 171662</p>
<p>171675 Rubber Adapter for Flush Mount</p> 	<p>Length: 114.4 mm Height: 24.9 mm Width: 40 mm</p>	<p>Colour: Black Material: Rubber</p>
<p>171728 Rubber Adapter for Flush Mount</p> 	<p>Length: 92 mm Height: 25.2 mm Width: 40 mm</p>	<p>Colour: Black Material: Rubber</p>

171766 Rubber Boot

Servicing: HC-CARGO 171765

For flush mount of HC-CARGO 171765.

 Colour: Black
 Material: Rubber

171816 Rubber Adapter for Flush Mount

Servicing: HC-CARGO 171815

 Length: 100.6 mm
 Height: 15.7 mm
 Width: 38 mm

 Colour: Black
 Material: Rubber

171817 Rubber Adapter for Flush Mount

Servicing: HC-CARGO 171813, 171814

 Length: 142 mm
 Height: 17.5 mm
 Width: 41 mm

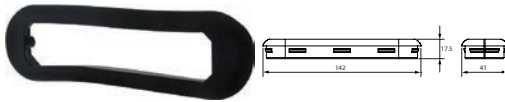
 Colour: Black
 Material: Rubber

171907 Rubber Adapter for Flush Mount

Servicing: HC-CARGO 171906

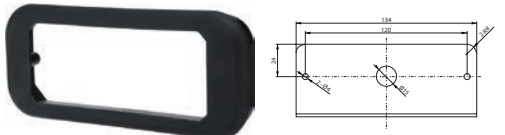
 Length: 144 mm
 Height: 61 mm
 Width: 20 mm

 Colour: Black
 Material: Rubber

171908 Mounting Bracket

Servicing: HC-CARGO 171906

Angled. For single head.

LIGHT BARS CONVENTIONAL
171681 Mini Light Bar

 Bulb incl.: Yes
 12 V
 Voltage: 12/24

 Length: 400 mm
 Height: 134 mm
 Width: 180 mm

 Bulb type: H1 12 V
 Lens type: Polycarbonate
 Colour: Orange
 Material: ABS plastic
 Mount.: Plan
 Base: Rigid
 Hi impact: Yes
 Coiled cable incl.: No
 Waterproof: Yes
 Tightness norm: IP 56
 Approvals: CE
 E-approval: Yes

SPARE PARTS

171820 Belt for Mini Light Bar

Servicing: HC-CARGO 171681



Colour: Black

LIGHT BARS LED

171680 LED Mini Light Bar

Bracket for permanent mounting: HC-CARGO 171682. Change flash pattern on cigarplug. Can also be connected permanently.



Voltage: 12/24

Length: 422 mm
Cable length: 3000 mm
Height: 65 mm
Width: 278 mm

Bulb type: 40x1W LED
Lens type: Polycarbonate
Colour: Orange
Model: FALCON
Mount.: Plan
Base: Magnetic/vacuum
Hi impact: Yes
Waterproof: Yes
Tightness norm: IP 66
Approvals: SAE/CE

171760 LED Light bar

Spare Parts: HC-CARGO 171778. Accessories: HC-CARGO 171777, 171779, 171780, 171781, 171762.



Voltage: 12
Amp: 11.2

Length: 1100 mm
Height: 67 mm
Width: 317 mm

Lens type: Polycarbonate
Colour: Orange
Material: Aluminium
Model: 110 cm/44"
Mount.: Plan
Base: Flexible
Hi impact: Yes
Waterproof: Yes
Approvals: SAE/CE

171761 LED Light bar

Spare Parts: HC-CARGO 171778. Accessories: HC-CARGO 171777, 171779, 171780, 171781, 171762.



Voltage: 12
Amp: 11.2

Length: 1470 mm
Height: 67 mm
Width: 317 mm

Lens type: Polycarbonate
Colour: Orange
Material: Aluminium
Model: 147 cm/59"
Mount.: Plan
Base: Flexible
Hi impact: Yes
Waterproof: Yes
Approvals: SAE/CE

171849 LED Light bar

Spare Parts: HC-CARGO 171856, 171858. Accessories: HC-CARGO 171781, 171762. Recommended fuse 15 A.

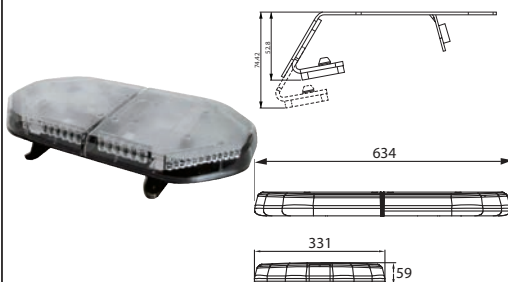

Voltage: 12
Amp: 10.4

Length: 634 mm
Height: 59 mm
Width: 331 mm

Lens type: Polycarbonate
Colour: Orange
Material: Aluminium
Model: 65 cm/24"
Mount.: Plan
Base: Flexible
Hi impact: Yes
Waterproof: Yes
Approvals: SAE/ECE-R65
E-approval: Yes

171850 LED Light bar

Spare Parts: HC-CARGO 171856, 171858. Accessories: HC-CARGO 171781, 171762. Recommended fuse 20 A.



Voltage: 12
Amp: 13.4

Length: 1087 mm
Height: 59 mm
Width: 331 mm

Lens type: Polycarbonate
Colour: Orange
Material: Aluminium
Model: 110 cm/43"
Mount.: Plan
Base: Flexible
Hi impact: Yes
Waterproof: Yes
Approvals: SAE/ECE-R65
E-approval: Yes

171851 LED Light bar

Spare Parts: HC-CARGO 171857, 171859. Accessories: HC-CARGO 171865, 171762. Recommended fuse 15 A.



Voltage: 24
Amp: 8.2

Length: 1087 mm
Height: 59 mm
Width: 331 mm

Lens type: Polycarbonate
Colour: Orange
Material: Aluminium
Model: 110 cm/43"
Mount.: Plan
Base: Flexible
Hi impact: Yes
Waterproof: Yes
Approvals: SAE/ECE-R65
E-approval: Yes

171852 LED Light bar

Spare Parts: HC-CARGO 171856, 171858. Accessories: HC-CARGO 171781, 171762. Recommended fuse 25 A.

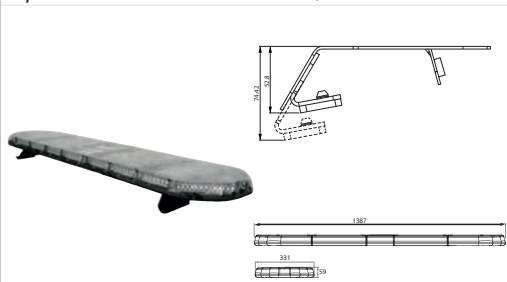

Voltage: 12
Amp: 16.2

Length: 1387 mm
Height: 59 mm
Width: 331 mm

Lens type: Polycarbonate
Colour: Orange
Material: Aluminium
Model: 140 cm/54"
Mount.: Plan
Base: Flexible
Hi impact: Yes
Waterproof: Yes
Approvals: SAE/ECE-R65
E-approval: Yes

171853 LED Light bar

Spare Parts: HC-CARGO 171857, 171859. Accessories: HC-CARGO 171865, 171762. Recommended fuse 15 A.

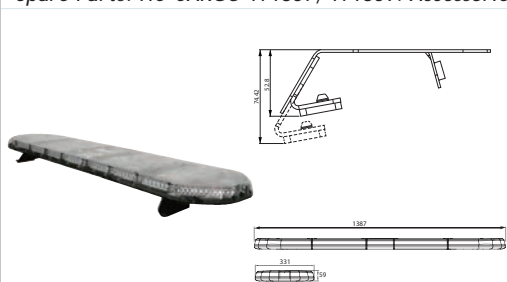

Voltage: 24
Amp: 10.2

Length: 1387 mm
Height: 59 mm
Width: 331 mm

Lens type: Polycarbonate
Colour: Orange
Material: Aluminium
Model: 140 cm/54"
Mount.: Plan
Base: Flexible
Hi impact: Yes
Waterproof: Yes
Approvals: SAE/ECE-R65
E-approval: Yes

171854 LED Micro Light Bar

Bracket for permanent mounting: HC-CARGO 171855. Change flash pattern on cigarplug. Can also be connected permanently.



Voltage: 12/24
Amp: 4.2/1.05

Length: 248 mm
Height: 37 mm
Width: 172 mm

Bulb type: 30x1 W LED
Lens type: Polycarbonate
Colour: Orange
Mount.: Plan
Base: Magnetic
Flash patterns: 23
Waterproof: Yes
Approvals: SAE/ECE-R65
E-approval: Yes

171909 LED Light bar

Spare Parts: HC-CARGO 171915, 171916. Accessories: HC-CARGO 171781, 171762. Recommended fuse 25 A.

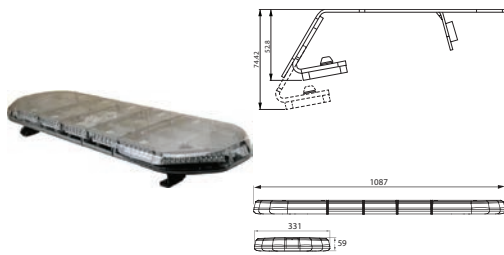

Voltage: 12
Amp: 16.4

Length: 1087 mm
Height: 59 mm
Width: 331 mm

Lens type: Polycarbonate
Colour: Blue
Material: Aluminium
Model: 110 cm/43"
Mount.: Plan
Base: Flexible
Hi impact: Yes
Waterproof: Yes
Approvals: SAE/ECE-R65
E-approval: Yes

171910 LED Light bar

Spare Parts: HC-CARGO 171856, 171858. Accessories: HC-CARGO 171781, 171762. Recommended fuse 20 A.

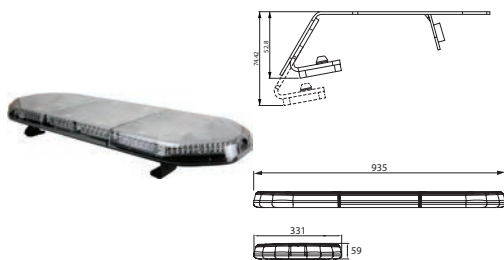

Voltage: 12
Amp: 12

Length: 935 mm
Height: 59 mm
Width: 331 mm

Lens type: Polycarbonate
Colour: Orange
Material: Aluminium
Model: 91.4 cm - 36"
Mount.: Plan
Base: Flexible
Hi impact: Yes
Waterproof: Yes
Approvals: SAE/ECE-R65
E-approval: Yes

171911 LED Light bar

Spare Parts: HC-CARGO 171857, 171859. Accessories: HC-CARGO 171865, 171762. Recommended fuse 15 A.



Voltage: 24
Amp: 7.2

Length: 935 mm
Height: 59 mm
Width: 331 mm

Lens type: Polycarbonate
Colour: Orange
Material: Aluminium
Model: 91.4cm - 36"
Mount.: Plan
Base: Flexible
Hi impact: Yes
Waterproof: Yes
Approvals: SAE/ECE-R65
E-approval: Yes

171912 LED Light bar

Spare Parts: HC-CARGO 171856, 171858. Accessories: HC-CARGO 171781, 171762. Recommended fuse 25 A.

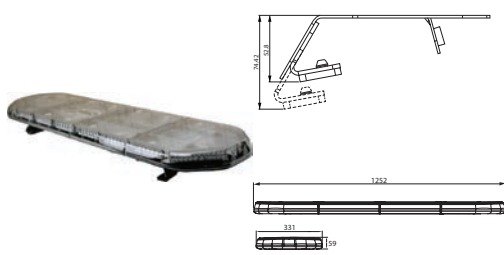

Voltage: 12
Amp: 14.8

Length: 1252 mm
Height: 59 mm
Width: 331 mm

Lens type: Polycarbonate
Colour: Orange
Material: Aluminium
Model: 124.5 cm/49"
Mount.: Plan
Base: Flexible
Hi impact: Yes
Waterproof: Yes
Approvals: SAE/ECE-R65
E-approval: Yes

171913 LED Light bar

Spare Parts: HC-CARGO 171857, 171859. Accessories: HC-CARGO 171865, 171762. Recommended fuse 15 A.

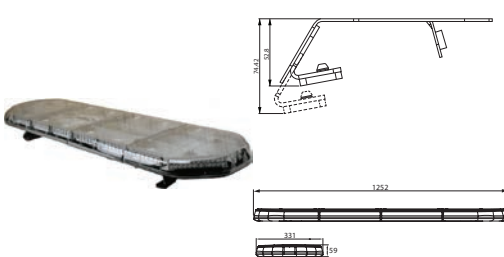

Voltage: 24
Amp: 9.2

Length: 1252 mm
Height: 59 mm
Width: 331 mm

Lens type: Polycarbonate
Colour: Orange
Material: Aluminium
Model: 124.5 cm/49"
Mount.: Plan
Base: Flexible
Hi impact: Yes
Waterproof: Yes
Approvals: SAE/ECE-R65
E-approval: Yes

171914 LED Light bar

Spare Parts: HC-CARGO 171857, 171859. Accessories: HC-CARGO 171865, 171762. Recommended fuse 20 A.

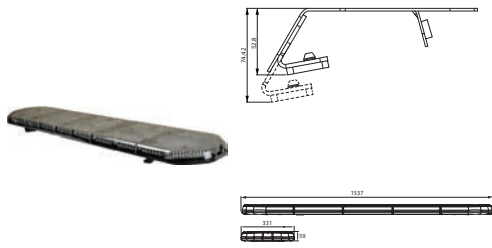

Voltage: 24
Amp: 11.2

Length: 1524 mm
Height: 59 mm
Width: 331 mm

Lens type: Polycarbonate
Colour: Orange
Material: Aluminium
Model: 152.4 cm/60"
Mount.: Plan
Base: Flexible
Hi impact: Yes
Waterproof: Yes
Approvals: SAE/ECE-R65
E-approval: Yes

ACCESSORIES
171682 Mounting Bracket for LED Mini Light Bar Servicing: HC-CARGO 171680

Thickness: 3 mm
Dist. mount. holes:
212 mm

171762 Switch Panel

Servicing: HC-CARGO 171760, 171761, 171849, 171850, 171851, 171852, 171853, 171909, 171910, 171911, 171912, 171913, 171914

Dim: 134x39x23 mm.



Mount. hole size:
4 mm

Type/terminal: Flat
Colour: Black
Button colour: Black
Material: Metal
Switch: S1-S4 On/Off, S5 Shift

171777 LED Flash, amber

Servicing: HC-CARGO 171760, 171761

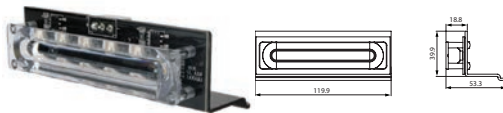

Voltage: 12

Length: 119.9 mm
Height: 39.9 mm
Width: 18.8 mm

Bulb type: 6 LED
Colour: Orange

171778 LED Corner Flash, orange

Servicing: HC-CARGO 171760, 171761

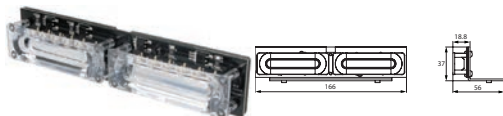

Voltage: 12

Length: 166 mm
Height: 37 mm
Width: 18.8 mm

Bulb type: 12 LED
Colour: Orange

171779 LED Work Lamp

Servicing: HC-CARGO 171760, 170761

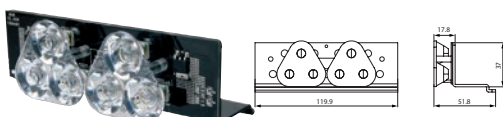

Voltage: 12

Length: 119.9 mm
Height: 37 mm
Width: 17.8 mm







Bulb type: 6 LED
Colour: Orange

	EL. SPECIFICATIONS	DIMENSIONS	ADDITIONAL SPECIFICATIONS
171780 LED Work Lamp 	Servicing: HC-CARGO 171760, 171761 Voltage: 12	Length: 119.9 mm Height: 37 mm Width: 17.8 mm	Bulb type: 9 LED
171781 LED Alley light 	Servicing: HC-CARGO 171760, 171761, 171749, 171850, 171852, 171909, 171910, 171913 Voltage: 12	Length: 38 mm Height: 39.2 mm Width: 18.1 mm	Bulb type: 3 LED Approvals: SAE/ECE-R65 E-approval: Yes
171855 Mounting Bracket for LED Micro Light Bar 	Servicing: HC-CARGO 171854	Total length: 203.9 mm Height: 14 mm Dist. mount. holes: 64/184 mm Width: 35 mm	
171856 LED Flash, amber 	Servicing: HC-CARGO 171760, 171761, 171849, 171850, 171852, 171910, 171912 Voltage: 12	Length: 120 mm Height: 36.75 mm Width: 18.78 mm	Bulb type: 6 LED Colour: Orange Approvals: SAE/ECE-R65 E-approval: Yes
171857 LED Flash, amber 	Servicing: HC-CARGO 171851, 171853, 171911, 171913, 171914 Voltage: 24	Length: 120 mm Height: 36.75 mm Width: 18.78 mm	Bulb type: 6 LED Colour: Orange Approvals: SAE/ECE-R65 E-approval: Yes
171858 LED Corner Flash, orange 	Servicing: HC-CARGO 171760, 171761, 171849, 171850, 171852, 171910, 171912 Voltage: 12	Length: 164 mm Height: 33 mm Width: 28.28 mm	Bulb type: 12 LED Colour: Orange Approvals: SAE/ECE-R65

ACCESSORIES - Lighting

O.E.M. names and numbers are used for reference purposes only.

	EL. SPECIFICATIONS	DIMENSIONS	ADDITIONAL SPECIFICATIONS
171859 LED Corner Flash, orange			
Servicing: HC-CARGO 171851, 171853, 171911, 171913, 171914			
	Voltage: 24	Length: 164 mm Height: 33 mm Width: 28.28 mm	Bulb type: 12 LED Colour: Orange Approvals: SAE/ECE-R65 E-approval: Yes
171865 LED Alley light			
Servicing: HC-CARGO 171851, 171853, 171911, 171913, 171914			
	Voltage: 24	Height: 38.41 mm	Bulb type: 3 LED Approvals: SAE/ECE-R65 E-approval: Yes
171915 LED Flash, blue			
Servicing: HC-CARGO 171909			
	Voltage: 12	Length: 120 mm Height: 36.75 mm Width: 18.78 mm	Bulb type: 6 LED Colour: Blue Approvals: SAE/ECE-R65 E-approval: Yes
171916 LED Corner Flash			
Servicing: HC-CARGO 171909			
	Voltage: 12	Length: 164 mm Height: 33 mm Width: 28.28 mm	Bulb type: 12 LED Colour: Blue Approvals: SAE/ECE-R65 E-approval: Yes
BEACON SOCKETS			
170292 Beacon Socket			
			Material: Steel Mount.: Weld Bracket: Straight Socket: DIN 72591 1 terminal
170387 Beacon Socket			
			Material: Electro galvanized Mount.: w/ nuts Bracket: Straight Socket: DIN 72591 1 terminal

EL. SPECIFICATIONS	DIMENSIONS	ADDITIONAL SPECIFICATIONS
<p>170405 Beacon Socket</p> 		<p>Material: Galvanised steel Mount.: Flat Bracket: Angled 90° Socket: DIN 72591 2 terminal</p>
<p>170406 Beacon Socket</p> 		<p>Material: Galvanised steel Mount.: 2 screws Bracket: Adjustable Socket: DIN 72591 2 terminal</p>
<p>170419 Beacon Socket</p> 		<p>Material: Galvanised steel Mount.: Vertical Bracket: Angled 90° Socket: DIN 72591 2 terminal</p>
<p>170460 Beacon Socket Servicing: John Deere tractor etc - Visit www.hc-cargo.com for further information</p>		
<p>170460 Beacon Socket</p> 		<p>Material: Galvanised steel Mount.: 1 bolt Bracket: Angled Socket: DIN 72591 2 terminal</p>
<p>170531 Extension</p> 		<p>Material: Galvanised steel Bracket: Straight Socket: DIN 72591 2 terminal</p>
<p>170537 Beacon Socket</p> 		<p>Material: Electro galvanized Mount.: Vertical Bracket: Straight Socket: DIN 72591 2 terminal</p>
<p>170562 Beacon Socket</p> 		<p>Material: Galvanised steel Mount.: 2 screws Bracket: Angled 90° Socket: DIN 72591 2 terminal</p>

170788 Beacon Socket

Material: Electro galvanized
Mount.: Flat
Bracket: Angled
Socket: DIN 72591 1 terminal

170789 Beacon Socket

Material: Electro galvanized
Bracket: Flexible
Socket: DIN 72591 1 terminal

171576 Beacon Socket

Servicing: IH/CASE



Material: Steel
Mount.: Vertical
Bracket: Straight
Socket: DIN 72591 2 terminal

SPARE PARTS
171513 Rubber Body for Beacon Socket

Servicing: HC-CARGO 170292, 170387, 170405, 170788, 170406, 170562, 170789, 170537, 171576, 170419, 170460



Material: Rubber

171518 Coiled Cable

Servicing: HC-CARGO 170292, 170387, 170405, 170788, 170406, 170562, 170789, 170537, 171576, 170419, 170460



Plug type: Cigar plug, Plug 1: 2
ISO norm: 4165

171562 Coiled Cable

Servicing: HC-CARGO 171763, 171764, 171494, 171495, 171496



Plug type: Cigar plug

180376 DIN Socket

Servicing: HC-CARGO 170292, 170387, 170405, 170788, 170406, 170562, 170789, 170537, 171576, 170419, 170460

Also used in sockets for beacons.

Material: Brass
No./poles: 1

180377 DIN Socket

Also used in sockets for beacons.



Material: Brass
No./poles: 2

WORK LAMPS CONVENTIONAL

170093 Work Lamp

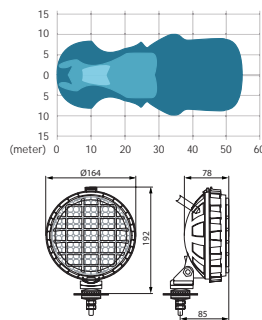

Bulb incl.: No

Dim.: 164x192x85 mm
Light aperture: 136 mm

Type: H3
Socket type: PK22s
Colour: Black
Material/dome: Glass
Material/house: Plastic
Reflector system: Single
Shape: Round
Switch: w/
Mount. bracket: Single bolt fixing
Grill: w/
Handle: w/

170130 Work Lamp

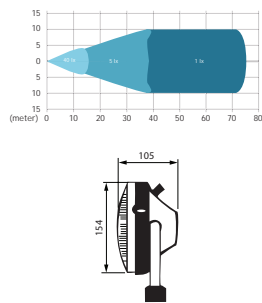

Bulb incl.: No

Dim.: 154x105 mm
Light aperture: 154x154 mm

Type: H3
Socket type: PK22s
Colour: Black
Material/dome: Glass
Material/house: Shockproof plastic
Reflector system: Single
Shape: Square
Switch: w/
Mount. bracket: U-bracket w/ 2 holes
Handle: w/

170237 Work Lamp

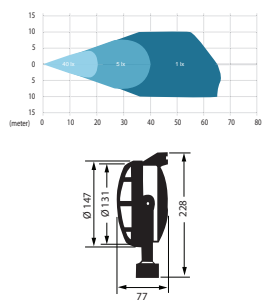

Bulb incl.: No

Dim.: 228x77 mm
Light aperture: 131 mm

Type: H3
Socket type: PK22s
Colour: Black
Material/dome: Glass
Material/house: Shockproof plastic
Reflector system: Single
Shape: Round
Switch: w/
Mount. bracket: U-bracket w/ 2 holes
Grill: w/
Handle: w/

170313 Work Lamp

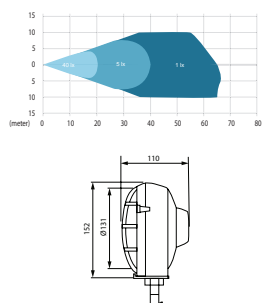

Bulb incl.: No

Dim.: 152x110 mm
Light aperture: 131 mm

Type: H3
Socket type: PK22s
Colour: Black
Material/dome: Glass
Material/house: Shockproof plastic
Reflector system: Single
Shape: Round
Switch: w/o
Mount. bracket: Single bolt fixing
Grill: w/
Handle: w/o

170489 Work Lamp

w/o U-bracket.

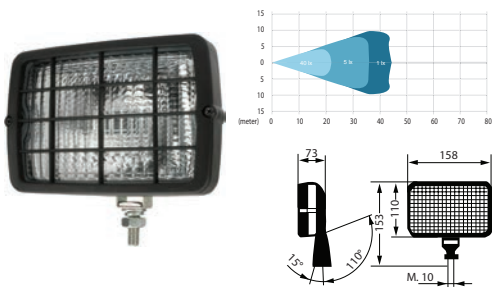

Bulb incl.: No

Dim.: 158x153x73 mm
Light aperture:
155x104 mm

Type: H3
Socket type: PK22s
Colour: Black
Material/dome: Glass
Material/house: Shockproof plastic
Reflector system: Single
Shape: Rectangular
Switch: w/o
Mount. bracket: Single bolt fixing
Grill: w/
Handle: w/o

170534 Work Lamp

Bracket: HC-CARGO 171936.

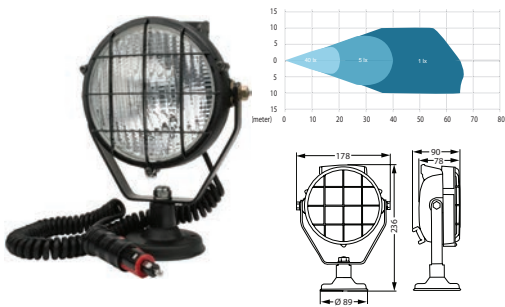

Bulb incl.: No

Dim.: 178x236x90 mm
Coiled cable: 2000 mm
Light aperture: 130 mm

Type: H3
Socket type: PK22s
Colour: Black
Material/dome: Glass
Material/house: Metal
Shape: Round
Switch: w/
Grill: w/
Magnet base: w/
Lighter plug incl.: Yes
Handle: w/
Coiled cable incl.: Yes

170851 Work Lamp

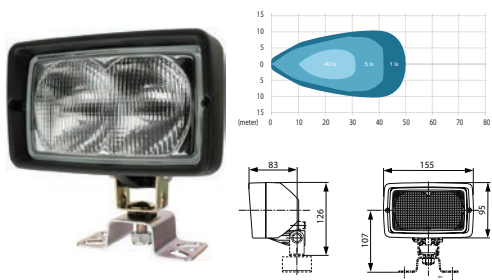

Bulb incl.: No

Dim.: 155x95x83 mm
Light aperture:
136x88 mm

Type: H3
Socket type: PK22s
Colour: Black
Material/dome: Glass
Material/house: Shockproof plastic
Reflector system: Dual
Shape: Rectangular
Switch: w/o
Mount. bracket: U-bracket w/ 6 holes
Handle: w/o
Tightness norm: IP 54

170857 Work Lamp

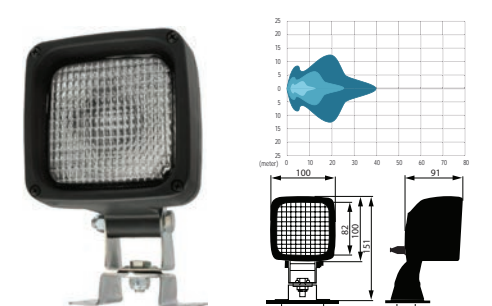

Bulb incl.: No

Dim.: 100x151x91 mm
Light aperture: 73x73 mm

Type: H3
Socket type: PK22s
Colour: Black
Material/dome: Glass
Material/house: Shockproof plastic
Reflector system: Free form
Shape: Square
Mount.: Upright/pendant
Switch: w/o
Mount. bracket: U-bracket w/ 4 holes
Grill: w/o
Handle: w/o
2 poles: w/
Tightness norm: IP 66

170859 Work Lamp

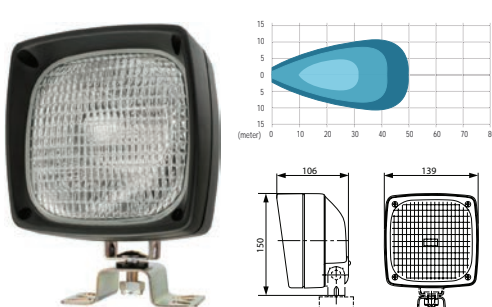

Bulb incl.: No

Dim.: 139x150x106 mm
Light aperture:
123x123 mm

Type: H3
Socket type: PK22s
Colour: Black
Material/dome: Glass
Material/house: Shockproof plastic
Reflector system: Free form
Shape: Square
Switch: w/o
Mount. bracket: U-bracket w/ 6 holes
Handle: w/o

170970 Work Lamp

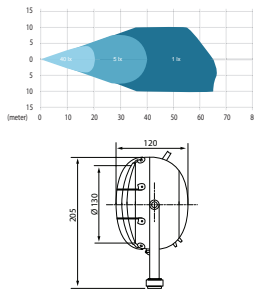

Bulb incl.: No

Dim.: 205x120 mm
Light aperture: 130 mm

Type: H3
Socket type: PK22s
Colour: Black
Material/dome: Glass
Material/house: Metal
Shape: Round
Switch: w/
Mount. bracket: U-bracket w/ 2 holes
Grill: w/
Handle: w/

170979 Work Lamp

External plug for flat plug connection.

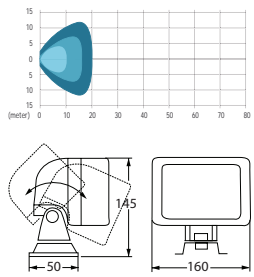

Bulb incl.: No

Dim.: 160x145x50 mm
Light aperture: 123x72 mm

Type: H3
Socket type: PK22s
Colour: Black
Material/dome: Glass
Material/house: Shockproof plastic
Shape: Rectangular
Mount.: Flat
Switch: w/o
Mount. bracket: U-bracket w/ 4 holes
Grill: w/o
Handle: w/o

170980 Work Lamp

Servicing: Universal - Visit www.hc-cargo.com for further information

External plug for flat plug connection.

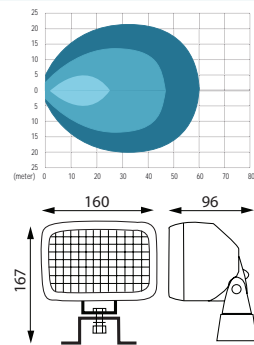

Bulb incl.: No

Dim.: 160x167x96 mm
Light aperture: 123x78 mm

Type: H3
Socket type: PK22s
Colour: Black
Material/dome: Glass
Material/house: Shockproof plastic
Reflector system: Dual
Shape: Rectangular
Mount.: Flat
Switch: w/o
Mount. bracket: U-bracket w/ 4 holes
Grill: w/o
Handle: w/o
2 poles: w/o
Tightness norm: IP 65

170981 Work Lamp

External plug for flat plug connection.

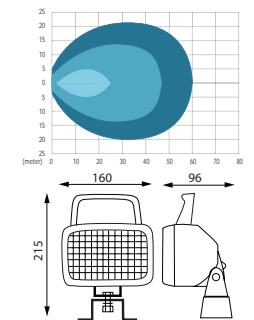

Bulb incl.: No

Dim.: 160x215x96 mm
Light aperture: 123x78 mm

Type: H3
Socket type: PK22s
Colour: Black
Material/dome: Glass
Material/house: Shockproof plastic
Reflector system: Dual
Shape: Rectangular
Mount.: Flat
Switch: w/
Mount. bracket: U-bracket w/ 4 holes
Handle: w/
2 poles: w/o
Tightness norm: IP 65

170982 Work Lamp

External plug for 6.3 mm flat plug connection.

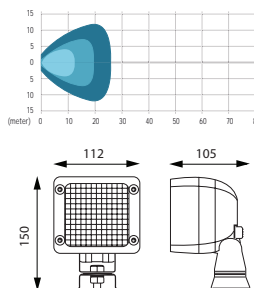

Bulb incl.: No

Dim.: 112x150x105 mm
Light aperture: 73x73 mm

Type: H3
Socket type: PK22s
Colour: Black
Material/dome: Glass
Material/house: Shockproof plastic
Reflector system: Single
Shape: Square
Mount.: Flat
Switch: w/o
Mount. bracket: U-bracket w/ 4 holes
Grill: w/o
Handle: w/o
Tightness norm: IP 67

170983 Work Lamp

External plug for 6.3 mm flat plug connection.

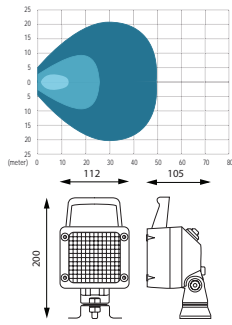

Bulb incl.: No

Dim.: 112x200x105 mm
Light aperture: 73x73 mm

Type: H3
Socket type: PK22s
Colour: Black
Material/dome: Glass
Material/house: Shockproof plastic
Reflector system: Single
Shape: Square
Mount.: Flat
Switch: w/
Mount. bracket: U-bracket w/ 4 holes
Handle: w/
Tightness norm: IP 65

170984 Work Lamp

External plug for 6.3 mm flat plug connection.

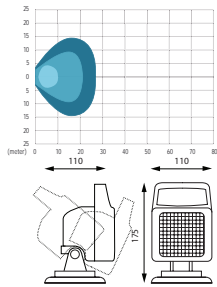

Bulb incl.: No

Dim.: 110x175x110 mm
Coiled cable: 2000 mm
Light aperture: 73x73 mm

Type: H3
Socket type: PK22s
Colour: Black
Material/dome: Glass
Material/house: Shockproof plastic
Reflector system: Single
Shape: Square
Switch: w/
Magnet base: w/
Lighter plug incl.: Yes
Handle: w/
2 poles: w/
Coiled cable incl.: Yes

171167 Work Lamp

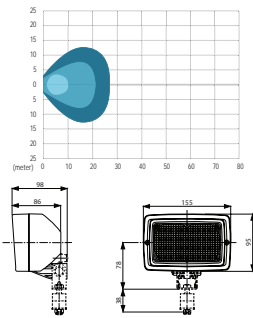

Bulb incl.: No

Dim.: 155x95x86 mm
Light aperture: 136x88 mm

Type: H3
Socket type: PK22s
Colour: Black
Material/dome: Glass
Material/house: Shockproof plastic
Reflector system: Dual
Shape: Rectangular
Switch: w/o
Mount. bracket: U-bracket w/ 6 holes
Handle: w/o
Tightness norm: IP 54

171168 Work Lamp

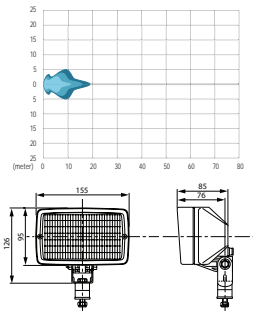

Bulb incl.: No

Dim.: 155x126x85 mm
Light aperture: 123x72 mm

Type: H3
Socket type: PK22s
Inclination/downwards: 40°
Inclination/upwards: 100°
Colour: Black
Material/dome: Glass
Material/house: Shockproof plastic
Reflector system: Single
Shape: Rectangular
Switch: w/o
Grill: w/o
Handle: w/o

171347 Work Lamp

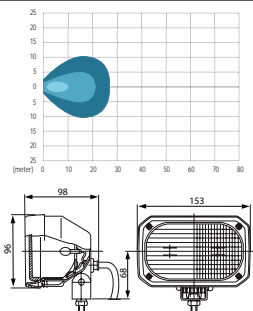

Bulb incl.: No

Dim.: 153x96x98 mm
Light aperture: 124x72 mm

Type: H3
Socket type: PK22s
Colour: Black
Material/dome: Glass
Material/house: Shockproof plastic
Reflector system: Single
Shape: Rectangular
Mount.: Upright/pendant
Switch: w/o
Mount. bracket: Single bolt fixing
Grill: w/o
Handle: w/o

171449 Work Lamp

External plug for multiplug connection.

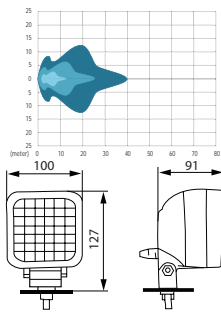

Bulb incl.: No

Dim.: 100x127x91 mm
Light aperture: 73x73 mm

Type: H3
Socket type: PK22s
Colour: Black
Material/dome: Shockproof plastic
Material/house: Glass
Reflector system: Single
Shape: Square
Mount.: Upright/pendant
Switch: w/o
Mount. bracket: Single bolt fixing
Grill: w/o
Handle: w/o
2 poles: w/
Tightness norm: IP 66

171564 Work Lamp

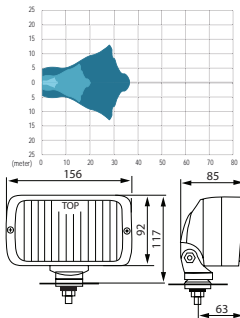

Bulb incl.: No

Dim.: 156x117x85 mm
Light aperture: 120x68 mm

Type: H3
Socket type: PK22s
Material/dome: Shockproof plastic
Material/house: Glass
Shape: Rectangular
Switch: w/
Grill: w/o
Handle: w/
Tightness norm: IP 55

171566 Work Lamp

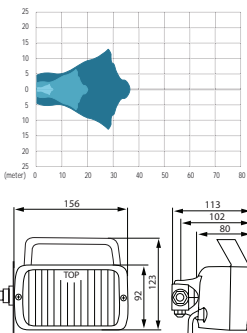

Bulb incl.: No

Dim.: 156x123x113 mm
Light aperture: 123x70 mm

Type: H3
Socket type: PK22s
Inclination/downwards: 180°
Inclination/upwards: 180°
Inclination/sideways: 105°
Colour: Black
Material/dome: Glass
Material/house: Shockproof plastic
Shape: Rectangular
Mount.: Sidemounted
Switch: w/o
Grill: w/o
Handle: w/o
Tightness norm: IP 55

171619 Work Lamp

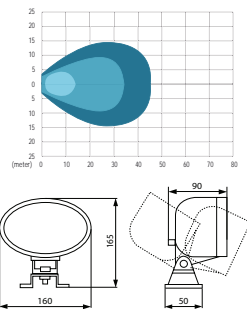

Bulb incl.: No

Dim.: 160x165x90 mm
Light aperture: 77x130 mm

Type: H3
Socket type: PK22s
Colour: Black
Material/dome: Glass
Material/house: Shockproof plastic
Reflector system: Single
Model: Compact 5000
Shape: Oval
Mount. bracket: 4 holes
2 poles: w/

171620 Work Lamp

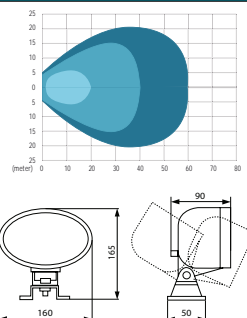

Bulb incl.: No

Dim.: 160x165x90 mm
Light aperture: 77x130 mm

Type: H3
Socket type: PK22s
Colour: Black
Material/dome: Shockproof plastic
Reflector system: Dual
Model: Twin beam 5000
Shape: Oval
Mount. bracket: 4 holes
2 poles: w/

171745 Work Lamp

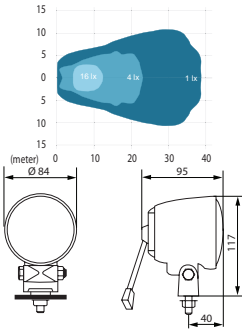

Bulb incl.: No

Dim.: 117x84x95 mm
Light aperture: 69 mm

Type: H3
Socket type: PK22s
Colour: Black
Material/dome: Glass
Material/house: ABS plastic
Reflector system: Single
Shape: Round
Switch: w/o
Mount. bracket: U-bracket w/ 1 bolt
Handle: w/o
2 poles: w/
Tightness norm: IP 66

171782 Work Lamp

w/ Deutsch multiconnection.

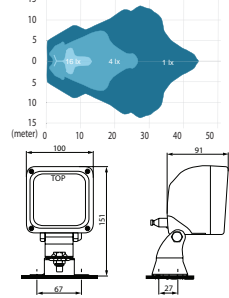

Bulb incl.: No

Dim.: 100x151x91 mm
Light aperture: 73x73 mm

Type: H3
Socket type: PK22s
Colour: Black
Material/dome: Glass
Material/house: Shockproof plastic
Reflector system: Single
Shape: Square
Mount.: Upright/pendant
Switch: w/
Mount. bracket: Single bolt fixing
Handle: w/o
2 poles: w/
Tightness norm: IP 66

171845 Work Lamp

Servicing: Marine - Visit www.hc-cargo.com for further information

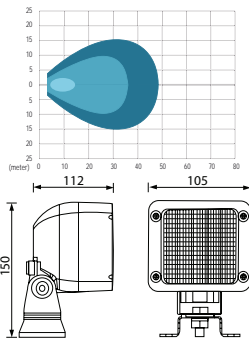

Bulb incl.: Yes
Voltage: 12
Watt: 55

Dim.: 105x150x112 mm

Type: H3
Socket type: PK22s
Colour: White
Material/dome: Glass
Shape: Square
Mount.: Single bolt fixing
Mount. bracket: Mounting bracket
Tightness norm: IP 65

171848 Work Lamp

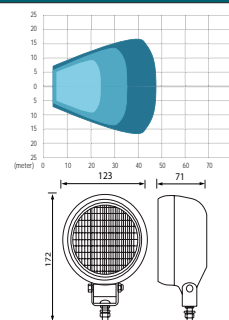

Bulb incl.: No

Dim.: 123x172x71 mm

Type: H3
Socket type: PK22s
Colour: Black
Material/dome: Glass
Material/house: PVC
Shape: Round
Mount. bracket: Single bolt fixing

WORK LAMPS LED

171640 LED Work Lamp

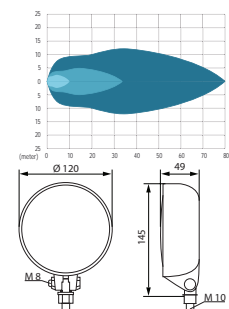

Voltage: 9-30
Watt: 24
Lumen: 1440

Dim.: 120x145x49 mm
Light aperture: 130 mm

Type: LED
Colour: Grey
Material/house: Aluminium
Model: 8 LED
Shape: Round
Switch: w/o
Mount. bracket: 1 nut
Magnet base: w/o
Handle: w/o
2 poles: w/
Tightness norm: IP 69K
Approvals: GGVS/ADR
E-approval: Yes

171671 LED Work Lamp

4 diodes. Black cable negative.

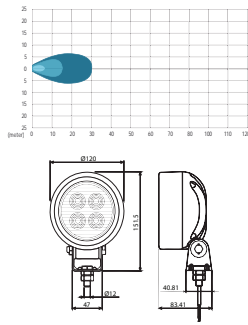

Voltage: 9-56
Watt: 8.5
Candela: 800
Kelvin: 5000-6500
Lumen: 450

Dim.: 120x151.5x83.41 mm
Light aperture: 100 mm

Type: LED
Colour: Black
Material/dome: Shockproof plastic
Material/house: Shock thermo plastic
Shape: Round
Switch: w/o
Mount. bracket: 1 nut
Magnet base: w/o
Handle: w/o
2 poles: w/o
Tightness norm: IP 66

171672 LED Work Lamp

4 diodes.

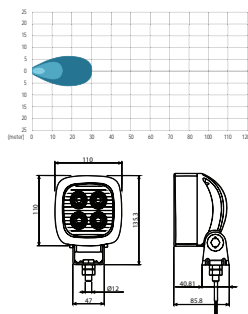

Voltage: 9-56
Watt: 8.5
Candela: 800
Kelvin: 5000-6500
Lumen: 450

Dim.: 110x135.5x85.8 mm
Light aperture: 100 mm

Type: LED
Colour: Black
Material/dome: Shockproof plastic
Material/house: Shockproof plastic
Shape: Square
Mount. bracket: 1 nut
Tightness norm: IP 66

171723 LED Work Lamp

Servicing: Marine - Visit www.hc-cargo.com for further information

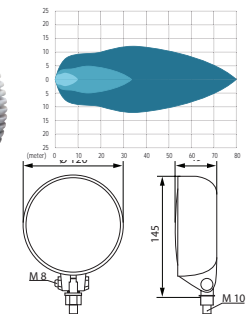

Voltage: 9-30
Watt: 24
Lumen: 1440

Dim.: 145x120x49 mm
Light aperture: 130 mm

Type: LED
Colour: White
Material/house: Aluminium
Model: 8 LED - Marine
Shape: Round
Mount. bracket: 1 nut
2 poles: w/
Tightness norm: IP 69K
Approvals: GGVS/ADR
E-approval: Yes

171727 LED Work Lamp

Grey lead +, white lead -.

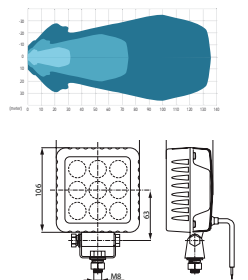

Voltage: 9-33
Watt: 9
Kelvin: 5000-5500
Lumen: 800-1000

Dim.: 106x106x59 mm
Light aperture: 85x85 mm

Type: LED
Colour: Black
Material/dome: Shockproof plastic
Material/house: Cast aluminum
Model: 9 LED
Shape: Square
Switch: w/o
Mount. bracket: U-bracket w/ 1 bolt
Handle: w/o
Tightness norm: IP 67
Approvals: CE/EMC

171751 LED Work Lamp

White cable to ground. Black cable to +12/36 V.

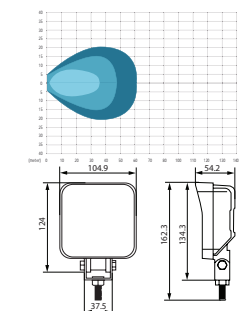

Voltage: 9-36
Watt: 19
Candela: 2210
Lumen: 1200

Dim.: 104.9x162.3x54.2 mm
Light aperture: 100x100 mm

Type: LED
Colour: Black
Material/dome: Polycarbonate
Material/house: Cast aluminum
Model: 6 LED
Switch: w/o
Mount. bracket: U-bracket w/ 1 bolt
Handle: w/o
Tightness norm: IP 69K
Approvals: CE/EMC

171752 LED Work Lamp

White cable to ground. Black cable to +12/36 V.

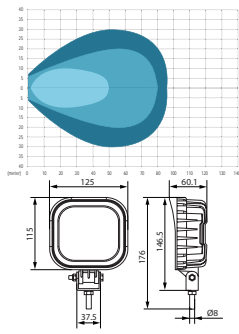

Voltage: 12-36
Watt: 20
Candela: 3600
Lumen: 1800

Dim.: 125x176x60.1 mm
Light aperture: 93x83 mm

Type: LED
Colour: Black
Material/dome: Polycarbonate
Material/house: Cast aluminum
Model: 9 LED
Switch: w/o
Mount. bracket: U-bracket w/ 1 bolt
Tightness norm: IP 69K

171753 LED Work Lamp

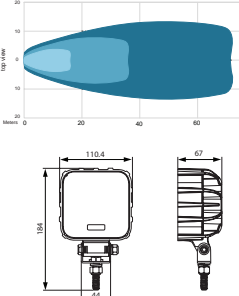

Voltage: 11-70
Watt: 22
Lumen: 1000

Dim.: 110.4x184x67 mm
Light aperture: 88x88 mm

Type: LED
Colour: Black
Material/house: Cast aluminum
Model: 6 LED
Shape: Square
Mount. bracket: Single bolt fixing
Tightness norm: IP 67

171755 LED Work Lamp

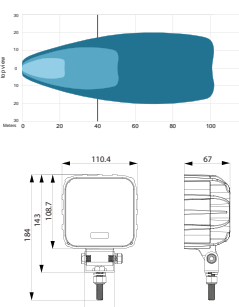

Voltage: 11-70
Watt: 27
Lumen: 1900

Dim.: 110.4x184x67 mm
Light aperture: 88x88 mm

Type: LED
Colour: Black
Material/house: Cast aluminum
Model: 6 LED
Mount. bracket: Single bolt fixing
Tightness norm: IP 67
E-approval: No

171774 LED Work Lamp

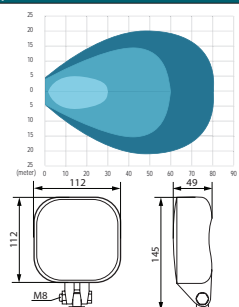

Voltage: 11-30
Watt: 40
Lumen: 3200

Dim.: 112x112x49 mm

Type: LED
Colour: Silver
Material/house: Cast aluminum
Model: 12 LED
Shape: Square
Mount. bracket: U-bracket w/ 1 bolt
Tightness norm: IP 69K
Approvals: GGVS/ADR
E-approval: Yes

171775 LED Work Lamp

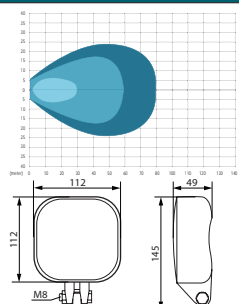

Voltage: 11-30
Watt: 36
Lumen: 1800

Dim.: 112x112x49 mm

Type: LED
Colour: Silver
Material/house: Cast aluminum
Model: 12 LED
Mount. bracket: U-bracket w/ 1 bolt
Tightness norm: IP 69K
Approvals: EMC/ADR/GGVS

171811 LED Work Lamp

Pre-wired w/ 30 cm cable.

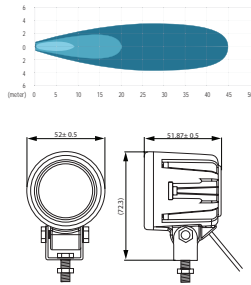

Voltage: 10-80
Watt: 5
Candela: 2000
Kelvin: 5000-6500
Lumen: 600

Dim.: 72.3x52x51.87 mm
Light aperture: 35 mm

Type: LED
Inclination/downwards: Yes
Inclination/upwards: Yes
Colour: Black
Material/dome: Plastic
Material/house: Aluminium
Shape: Round
Mount. bracket: U-bracket w/ 1 bolt
Tightness norm: IP 66
Approvals: CE

171838 LED Work Lamp

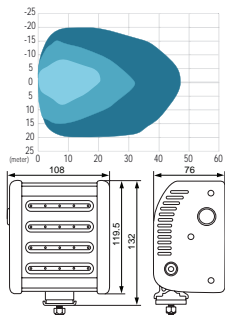

Voltage: 9-36
Amp: 1.2/2.5
Watt: 28-30
Lumen: 3000

Dim.: 132x108x76 mm

Colour: Black
Material/dome: Polycarbonate
Material/house: Aluminium
Model: 20 LED
Shape: Square
Mount. bracket: Single bolt fixing
2 poles: w/
Tightness norm: IP 67
Approvals: CE

171846 LED Work Lamp

2 pin AMP connector.

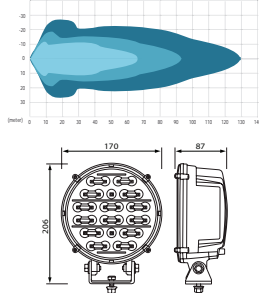

Voltage: 9-36
Amp: 6/3
Watt: 67.5
Lumen: 5400

Dim.: 170x206x87 mm

Type: LED
Inclination/downwards: 45°
Inclination/upwards: 45°
Colour: Black
Material/dome: Polycarbonate
Material/house: Aluminium
Shape: Round
Mount. bracket: U-bracket w/ 1 bolt
2 poles: w/
Tightness norm: IP 67
Approvals: CE

171932 LED Work Lamp

280 mm cable.

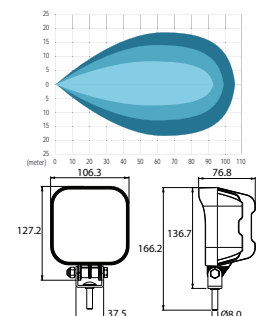

Voltage: 12-36
Watt: 40
Lumen: 3200

Dim.: 127.2x106.3x76.8 mm

Type: LED
Colour: Black
Material/house: Aluminium
Model: 4 LED
Shape: Square
Mount. bracket: U-bracket w/ 1 bolt
Tightness norm: IP 69K
Approvals: CE/EMC

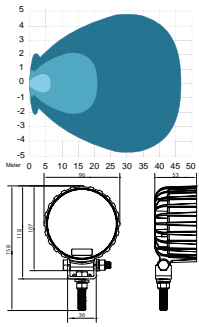
171938 LED Work Lamp
Flood type.

Voltage: 9-50
Amp: <0.55
Watt: 10.8
Lumen: 900

Dim.: 96x118x53 mm
Cable length: 380 mm
Light aperture: 90 mm

Type: 4 LED
Colour: Black
Material/dome: Polycarbonate
Material/house: Aluminium
Shape: Round
Mount. bracket: 1 bolt
Tightness norm: IP 68
Approvals: CE/EMC

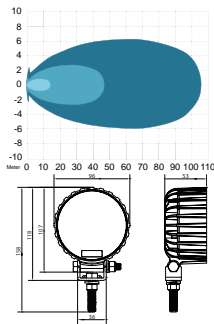
171939 LED Work Lamp
Spot.

Voltage: 9-50
Amp: <0.65
Watt: 11
Lumen: 900

Dim.: 96x118 mm
Cable length: 380 mm
Light aperture: 90 mm

Type: 4 LED
Colour: Black
Material/dome: Polycarbonate
Material/house: Aluminium
Shape: Round
Mount. bracket: 1 bolt
Tightness norm: IP 68
Approvals: CE/EMC

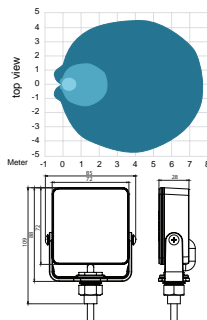
171940 LED Work Lamp

Voltage: 12-24
Amp: 0.37
Watt: 7.5

Dim.: 88x85 mm
Cable length: 380 mm
Light aperture: 72 mm

Type: 4 LED
Material/dome: Polycarbonate
Material/house: Aluminium
Shape: Square
Mount. bracket: U-bracket w/ 1 bolt
Tightness norm: IP 67
Approvals: CE

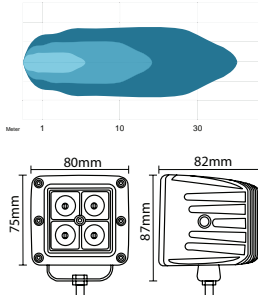
171944 LED Work Lamp

Voltage: 10-30
Watt: 16
Kelvin: 6000
Lumen: 800

Dim.: 87x80x75 mm

Bulb type: 4 LED
Colour: Black
Material/ bracket: Stainless steel
Material/dome: Polycarbonate
Material/house: Cast aluminum
Shape: Square
Mount.: Cable
Tightness norm: IP 67
Approvals: CE

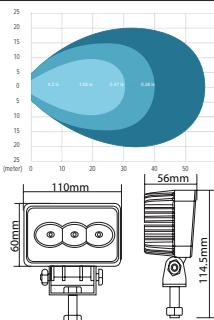
171945 LED Work Lamp

Voltage: 10-30
Watt: 9
Kelvin: 6000
Lumen: 600

Dim.: 60x110x56 mm

Bulb type: 3 LED
Colour: Black
Material/ bracket: Stainless steel
Material/dome: Polycarbonate
Material/house: Cast aluminum
Shape: Rectangular
Mount.: Cable
Tightness norm: IP 67
Approvals: CE

	EL. SPECIFICATIONS	DIMENSIONS	ADDITIONAL SPECIFICATIONS
171946 LED Work Lamp	<p>Voltage: 10-30 Watt: 18 Kelvin: 6000 Lumen: 1200</p>	Dim.: 60x110x56 mm	Bulb type: 6 LED Colour: Black Material/ bracket: Stainless steel Material/dome: Polycarbonate Material/house: Cast aluminum Shape: Rectangular Mount.: Cable Tightness norm: IP 67 Approvals: CE
171947 LED Work Lamp	<p>Voltage: 10-30 Watt: 20 Kelvin: 6000 Lumen: 1600</p>	Dim.: 60x110x56 mm	Bulb type: 2 LED Colour: Black Material/ bracket: Stainless steel Material/dome: Polycarbonate Material/house: Cast aluminum Shape: Rectangular Mount.: Cable Tightness norm: IP 67 Approvals: CE
171948 LED Work Lamp	<p>Voltage: 10-30 Watt: 15 Kelvin: 6000 Lumen: 1100</p>	Dim.: 128x110x48 mm	Bulb type: 5 LED Colour: Black Material/ bracket: Stainless steel Material/dome: Polycarbonate Material/house: Cast aluminum Shape: Square Mount.: Cable Tightness norm: IP 67 Approvals: CE
171949 LED Work Lamp	<p>Voltage: 10-30 Watt: 15 Kelvin: 6000 Lumen: 1100</p>	Dim.: 128x110x46 mm	Bulb type: 5 LED Colour: Black Material/ bracket: Stainless steel Material/dome: Polycarbonate Material/house: Cast aluminum Shape: Square Mount.: Cable Tightness norm: IP 67 Approvals: CE
171950 LED Work Lamp	<p>Voltage: 10-30 Watt: 18 Kelvin: 6000 Lumen: 1200</p>	Dim.: 128x116x48 mm	Bulb type: 6 LED Colour: Black Material/ bracket: Stainless steel Material/dome: Polycarbonate Material/house: Cast aluminum Shape: Round Mount.: Cable Tightness norm: IP 67 Approvals: CE
171951 LED Work Lamp	<p>Voltage: 10-30 Watt: 18 Kelvin: 6000 Lumen: 1200</p>	Dim.: 128x116x48 mm	Bulb type: 6 LED Colour: Black Material/ bracket: Stainless steel Material/dome: Polycarbonate Material/house: Cast aluminum Shape: Round Mount.: Cable Tightness norm: IP 67 Approvals: CE

171955 LED Work Lamp

Accessories: HC-CARGO 190252, 190261, 191029, 193010.

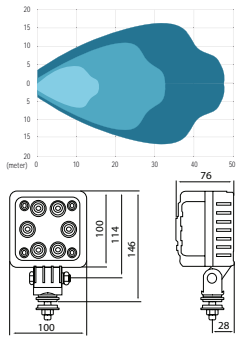

Voltage: 12-24
Watt: 24
Kelvin: 5000-7000
Lumen: 1500

Dim.: 100x100x76 mm

Type: 6 LED
Inclination/downwards: 80°
Inclination/upwards: 90°
Inclination/sideways: 180°
Colour: Black
Material/dome: Plastic
Material/house: Plastic
Plug: 171955pl
2 poles: w/
Tightness norm: IP 68
Approvals: CE

172001 LED Work Lamp

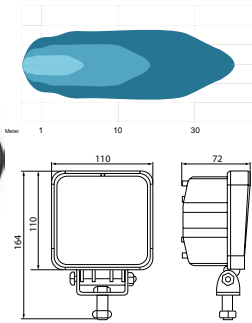

Voltage: 10-80
Watt: 48
Kelvin: 6000
Lumen: 2275

Dim.: 164x110x72 mm

Bulb type: 16 LED
Colour: Black
Material/ bracket: Stainless steel
Material/dome: Polycarbonate
Material/house: Cast aluminum
Shape: Square
Mount.: Cable
Tightness norm: IP 67
Approvals: CE

172003 LED Work Lamp

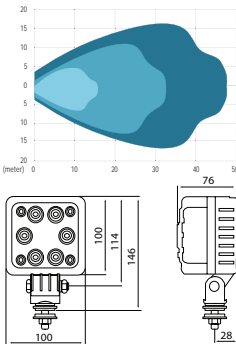

Voltage: 12-24
Watt: 24
Kelvin: 5000-7000
Lumen: 1500

Dim.: 100x100x76 mm
Cable length: 500 mm

Type: 6 LED
Inclination/downwards: 80°
Inclination/upwards: 90°
Inclination/sideways: 180°
Colour: Black
Material/dome: Plastic
Material/house: Plastic
Switch: w/
Plug: 172003pl
Tightness norm: IP 68
Approvals: CE

172004 LED Work Lamp

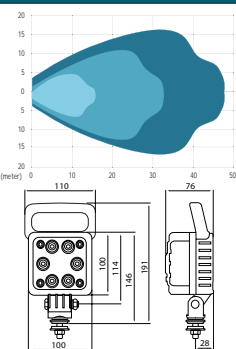

Voltage: 12-24
Watt: 24
Kelvin: 5000-7000
Lumen: 1500

Dim.: 191x110x76 mm
Cable length: 500 mm

Type: 6 LED
Inclination/downwards: 80°
Inclination/upwards: 90°
Inclination/sideways: 180°
Colour: Black
Material/dome: Plastic
Material/house: Plastic
Switch: w/
Handle: w/
Plug: 172004pl
Tightness norm: IP 68
Approvals: CE

172006 LED Work Lamp

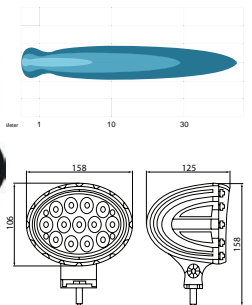

Voltage: 10-30
Watt: 65
Kelvin: 6000
Lumen: 5850

Dim.: 158x106x125 mm

Type: 13 LED
Material/ bracket: Stainless steel
Material/dome: Polycarbonate
Material/house: Cast aluminum
Tightness norm: IP 69K
Approvals: CE

ACCESSORIES

172005 Bracket

Servicing: HC-CARGO 171955, 172003, 172004



Dim.: 59x37 mm
Mount. hole size: 24 mm

Material: Plastic
Mount.: Standard ISO A - Rod

172008 Handle for LED Work Lamp

Servicing: HC-CARGO: 171948, 171949, 171950, 171951, 172001



Colour: Black
Material/ bracket: Aluminium
Mount. bracket: 2 screws

WORK LAMPS HID

171594 HID Work Lamp

Bulb: HC-CARGO 171595.

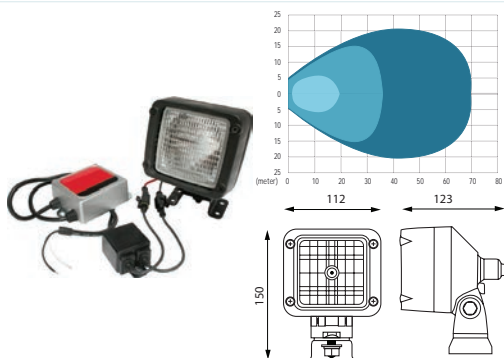

Bulb incl.: Yes
Voltage: 12

Dim.: 112x150x123 mm
Light aperture: 73x73 mm

Type: H3
Colour: Black
Material/dome: Glass
Material/house: Shockproof plastic
Shape: Square
Switch: w/o
Ballast: External
Mount. bracket: Mounting bracket
Magnet base: w/o
Handle: w/o
2 poles: w/
Tightness norm: IP 65

171611 HID Work Lamp

Bulb: HC-CARGO 171595.

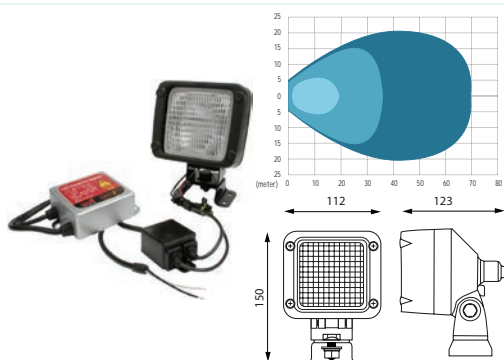

Bulb incl.: Yes
Voltage: 24

Dim.: 112x150x123 mm
Light aperture: 73x73 mm

Type: H3
Colour: Black
Material/dome: Glass
Material/house: Shockproof plastic
Model: HID
Shape: Square
Switch: w/o
Ballast: External
Mount. bracket: Mounting bracket
Magnet base: w/o
Handle: w/o
2 poles: w/
Tightness norm: IP 65

171615 HID Work Lamp

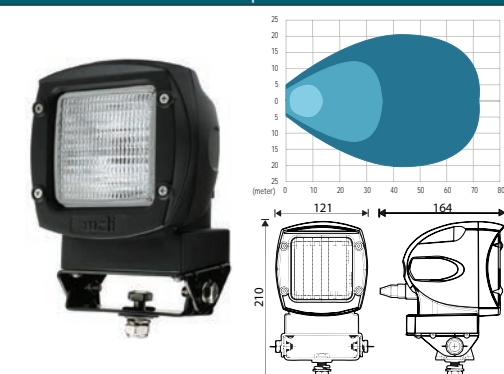

Bulb incl.: Yes
Voltage: 12
Watt: 35

Dim.: 121x210x164 mm
Light aperture: 73x73 mm

Type: D1S
Socket type: PK32d-2
Colour: Black
Material/dome: Glass
Material/house: Shockproof plastic
Reflector system: Single
Shape: Square
Switch: w/o
Mount. bracket: Mounting bracket
Magnet base: w/o
Handle: w/o
Tightness norm: IP 65

171625 HID Work Lamp

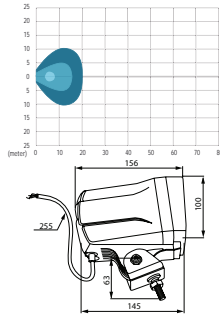

Bulb incl.: Yes
Voltage: 12
Watt: 35

Dim.: 156x100 mm
Light aperture: 75 mm

Type: D2S
Socket type: PK32d-2
Colour: Black
Material/dome: Glass
Material/house: Aluminium
Reflector system: Single
Shape: Square
Switch: w/o
Mount. bracket: U-bracket w/ 1 bolt
Magnet base: w/o
Handle: w/o
2 poles: w/o

171626 HID Work Lamp

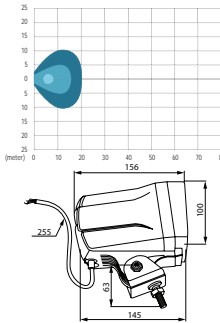

Bulb incl.: Yes
Voltage: 24
Watt: 35

Dim.: 156x100 mm
Light aperture: 75 mm

Type: D2S
Socket type: PK32d-3
Colour: Black
Material/dome: Glass
Material/house: Aluminium
Reflector system: Single
Shape: Square
Mount.: Single bolt fixing
Switch: w/o
Mount. bracket: Mounting bracket
Magnet base: w/o
Handle: w/o
2 poles: w/o

SPARE PARTS

171595 Xenon Bulb

Servicing: HC-CARGO 171594



Type: Xenon, H3

171612 Ballast

Servicing: HC-CARGO 171611

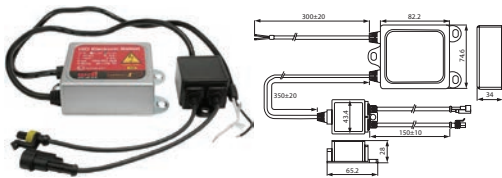

Voltage: 24

Model: HID

SPOT LIGHTS

170293 Spot Light

Hand-held.

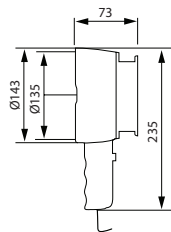

Bulb incl.: Yes
Voltage: 12
Watt: 55

Dim.: 235x73 mm
Cable length: 6000 mm
Connection cable: w/
Light aperture: 120 mm

Type: Halogen
H3
Socket type: PK22s
Colour: Black
Material/house: Shockproof plastic
Shape: Round
Switch: w/
Protective cover: w/
Lighter plug incl.: Yes
Connection cable: w/

170564 Spot Light

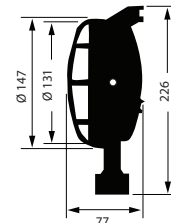

Bulb incl.: No

Dim.: 226x77 mm
Light aperture: 131 mm

Type: H3
Socket type: PK22s
Inclination/sideways: Yes
Colour: Black
Material/dome: Glass
Material/house: Shockproof plastic
Switch: w/
Grill: w/
Handle: w/

	EL. SPECIFICATIONS	DIMENSIONS	ADDITIONAL SPECIFICATIONS
<p>171375 Spot Light</p> 	<p>Bulb incl.: No</p>	<p>Dim.: 178x236x90 mm Coiled cable: 2000 mm Light aperture: 130 mm</p>	<p>Type: H3 Socket type: PK22s Colour: Black Material/dome: Glass Material/house: Metal Shape: Round Switch: w/ Mount. bracket: Mounting bracket Grill: w/ Magnet base: w/ Lighter plug incl.: Yes Handle: w/ Coiled cable incl.: Yes</p>
<p>171464 Spot Light</p> <p>Remote controlled by EU approved radio controller. Frequency 433.92 MHZ. Reach up to 100 m. Incl. 9 V battery. Battery: HC-CARGO 200742, 200769.</p> 	<p>Bulb incl.: Yes Voltage: 12 Watt: 55</p>	<p>Dim.: 250x135 mm</p>	<p>Mount.: Standard ISO A - Rod Tightness norm: IP 55</p>
<p>171466 Spot Light</p> <p>Remote controlled by EU approved radio controller. Frequency 433.92 MHZ. Reach up to 100 m. Incl. 9 V battery. Battery: HC-CARGO 200742, 200769.</p> 	<p>Bulb incl.: Yes Voltage: 12 Watt: 55</p>	<p>Dim.: 194x165 mm</p>	<p>Mount.: Standard ISO B2 (and B1) - Base Tightness norm: IP 55</p>
<h2>ACCESSORIES</h2>			
<p>170653 Beacon Socket</p> 	<p>Servicing: HC-CARGO 170650, 170651, 171466</p>		<p>Height: 30 mm Width: 2000 mm</p> <p>Mount.: 3 magnets Base: Magnetic Coiled cable incl.: Yes Tightness norm: IP 55 E-approval: Yes</p>
<p>171936 Magnetic base for Lamps</p> 	<p>Servicing: HC-CARGO 170534</p>		<p>Coiled cable: 2000 mm</p> <p>Colour: Black Mount.: Magnetic Mount. bracket: U-bracket w/ 2 holes Magnet base: w/ Lighter plug incl.: Yes Coiled cable incl.: Yes</p>

FORWARD LIGHTING

TRACTOR HEAD LAMPS

170132 Head Lamp

Light unit: HC-CARGO 170239.

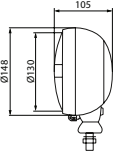
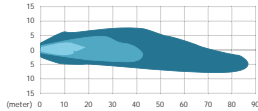

Bulb incl.: No
Watt: 45/40
Watt 2: 55/50
Watt 3: 4

Dim.: 148x105 mm
Light aperture: 130 mm

Bulb type: H4
Bulb type 2: H4
Socket type: P45t
Socket type 2: P45t
Socket type 3: BA9s
Colour: Black
Material: Metal
Material/dome: Glass
Shape: Round
Mount.: 1 bolt
Sidemarker: w/
Grill: w/o
Asymmetric light: w/
RH/LH: LH
E-approval: Yes

170310 Head Lamp

For upright fixing.

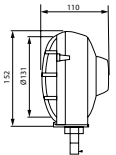
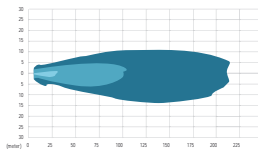

Bulb incl.: No
Watt: 45/40
Watt 2: 55/50
Watt 3: 4

Dim.: 152x110 mm
Light aperture: 131 mm

Bulb type: H4
Bulb type 2: H4
Socket type: P45t
Socket type 2: P45t
Socket type 3: BA9s
Colour: Black
Material: Plastic
Material/dome: Glass
Shape: Round
Mount.: 1 bolt
Sidemarker: w/
Grill: w/
Asymmetric light: w/
RH/LH: LH
E-approval: Yes

170311 Head Lamp

Horizontal fixing.

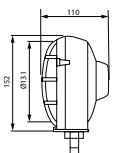
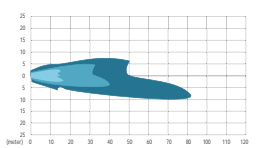

Bulb incl.: No
Watt: 45/40
Watt 2: 55/50
Watt 3: 4

Dim.: 152x110 mm
Light aperture: 131 mm

Bulb type: H4
Bulb type 2: H4
Socket type: P45t
Socket type 2: P45t
Socket type 3: BA9s
Colour: Black
Material: Plastic
Material/dome: Glass
Shape: Round
Mount.: 1 bolt
Sidemarker: w/
Grill: w/
Asymmetric light: w/
RH/LH: LH
E-approval: Yes

170843 Head Lamp



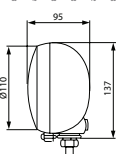
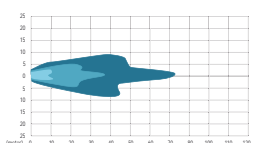





Light unit: HC-CARGO 170844.

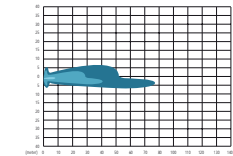
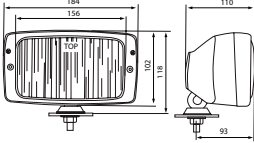

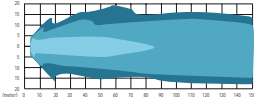
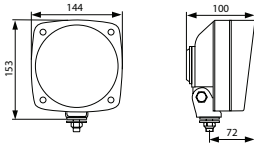
Bulb incl.: No
Watt: 45/40
Watt 2: 55/50
Watt 3: 4

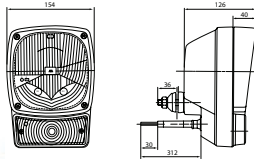
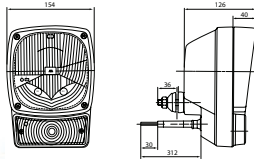
Dim.: 137x95 mm
Light aperture: 110 mm

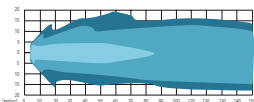
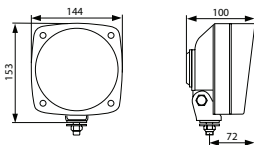
Socket type: BA20d
Socket type 2: BA20d
Socket type 3: BA9s
Colour: Black
Material: Metal
Material/dome: Glass
Shape: Round
Mount.: 1 bolt
Sidemarker: w/
Grill: w/o
Asymmetric light: w/o
RH/LH: RH/LH
E-approval: Yes

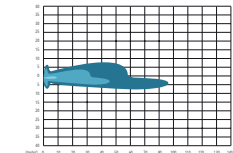
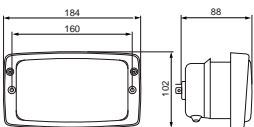
	EL. SPECIFICATIONS	DIMENSIONS	ADDITIONAL SPECIFICATIONS
170865 Head Lamp   	Servicing: Zetor: Model 2002, Proxima, Forterra, Super, Super Eko, Classic Eko - Visit www.hc-cargo.com for further information Bulb incl.: No Watt: 60/55 Watt 2: 75/70	Dim.: 184x118x110 mm Light aperture: 156 mm	Bulb type: H4 Bulb type 2: H4 Socket type: P43t Socket type 2: P43t Colour: Black Material: Shockproof plastic Material/dome: Glass Shape: Rectangular Mount.: Horizontal Asymmetric light: w/ RH/LH: LH E-approval: Yes
170974 Head Lamp   	Bulb incl.: No Watt: 60/65 Watt 2: 75/70	Dim.: 144x153x100 mm Light aperture: 110 mm	Bulb type: H4 Bulb type 2: H4 Socket type: P43t Socket type 2: P43t Colour: Black Material: Shockproof plastic Material/dome: Glass Shape: Rectangular Mount.: Horizontal/vertical Asymmetric light: w/ RH/LH: LH E-approval: Yes
171006 Head Lamp <i>Light unit: HC-CARGO 171007.</i>   	Bulb incl.: Yes 12 V Watt: 60/55 Watt 2: 75/70	Dim.: 208x154x126 mm Light aperture: 142 mm	Bulb type: H4 Bulb type 2: H4 Socket type: P43t Socket type 2: P43t Colour: Black Material: Shockproof plastic Material/dome: Glass Shape: Rectangular Mount.: Horizontal/vertical Flasher light: w/ Sidemarkers: w/ Asymmetric light: w/ RH/LH: RH/LH E-approval: Yes
171038 Head Lamp   	Bulb incl.: No Watt: 60/65 Watt 2: 75/70 Watt 3: 4	Dim.: 144x153x100 mm Light aperture: 110 mm	Bulb type: H4 Bulb type 2: H4 Socket type: P43t Socket type 2: P43t Socket type 3: BA9s Colour: Black Material: Shockproof plastic Material/dome: Glass Shape: Rectangular Mount.: Horizontal/vertical Sidemarkers: w/ Asymmetric light: w/ RH/LH: LH E-approval: Yes
171565 Head Lamp   	Bulb incl.: No Watt: 60/55 Watt 2: 75/70 Watt 3: 4	Dim.: 184x102x88 mm Light aperture: 160 mm	Bulb type: H4 Bulb type 2: H4 Socket type: P43t Socket type 2: P43t Socket type 3: BA9s Colour: Black Material: Shockproof plastic Material/dome: Glass Shape: Square Mount.: Horizontal/vertical Sidemarkers: w/ Grill: w/o Asymmetric light: w/ RH/LH: LH E-approval: Yes

SPARE PARTS
170239 Light Unit

Servicing: HC-CARGO 170132

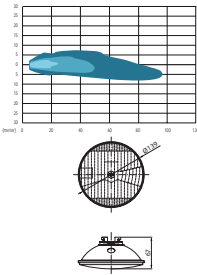

 Bulb incl.: No
 Watt: 45/40
 Watt 2: 55/50
 Watt 3: 4

 Dim.: 139x67 mm
 Light aperture: 130 mm

 Socket type: P45t
 Socket type 2: P45t
 Socket type 3: BA9s
 Material: Glass
 Shape: Round
 Sidemarker: w/
 Asymmetric light: w/
 RH/LH: LH
 E-approval: Yes

170844 Light Unit

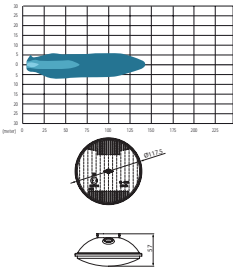
Servicing: HC-CARGO 170843



 Bulb incl.: No
 Watt: 45/40
 Watt 2: 55/50
 Watt 3: 4

 Dim.: 117.5x57 mm
 Light aperture: 110 mm

 Socket type: BA20d
 Socket type 2: BA20d
 Socket type 3: BA9s
 Shape: Round
 Asymmetric light: w/

171007 Light Unit

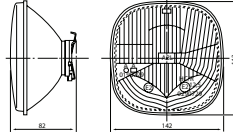
Servicing: HC-CARGO 171006, 170926

 Bulb incl.: No
 Watt: 60/55
 Watt 2: 75/70

 Dim.: 142x142x82 mm
 Light aperture: 142 mm

 Bulb type: H4
 Bulb type 2: H4
 Socket type: P43t
 Socket type 2: P43t
 Material: Glass
 Shape: Square
 Asymmetric light: w/
 E-approval: Yes

171008 Lens

Servicing: HC-CARGO 171006, 170926



Colour: Orange

171937 Bulb Gasket

Servicing: HC-CARGO 170865

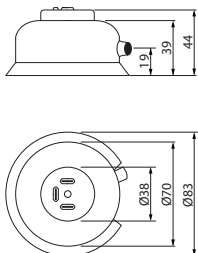

OD: 83 mm

Material: Rubber

HEADLIGHT INSERTS
170690 Light Unit

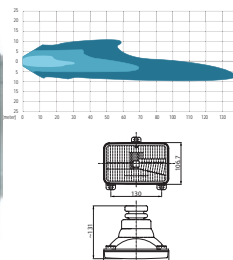
 Servicing: Chrysler, Fendt, Ford, GM, IH/Case, Isuzu, John Deere, Mazda - Visit www.hc-cargo.com for further information

 Bulb incl.: No
 Watt: 60/55
 Watt 2: 75/70

 Dim.: 167x106.7 mm
 Dist. mount. holes:
 130x110 mm

 Bulb type: H4
 Bulb type 2: H4
 Socket type: P43t
 Socket type 2: P43t
 Material: Metal
 Material/dome: Glass
 Shape: Rectangular
 Fixing screw: 3
 Asymmetric light: w/
 RH/LH: LH
 E-approval: Yes

170867 Head Lamp

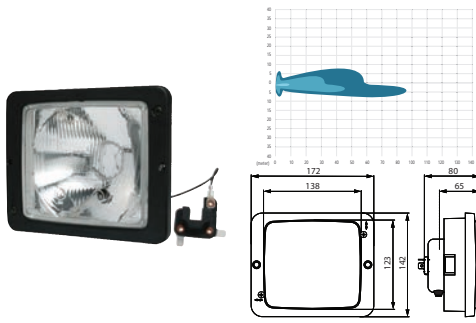
Heat resistant plastic reflector bonded w/ glass lens. Flush fitting head lA. Build-in depth: 69 mm.



Bulb incl.: No
Watt: 60/55
Watt 2: 75/70
Watt 3: 4

Dim.: 172x142x80 mm

Bulb type: H4
Bulb type 2: H4
Socket type: P43t
Socket type 2: P43t
Socket type 3: BA9s
Material: Metal
Material/dome: Glass
Fixing screw: 2
Sidemarker: w/
E-approval: Yes

170868 Light Unit

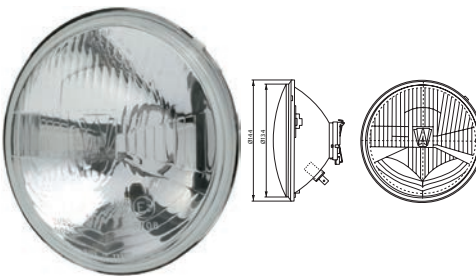

Bulb incl.: No
Watt: 60/55
Watt 2: 75/70
Watt 3: 4

OD: 144 mm
Light aperture: 134 mm

Bulb type: H4
Bulb type 2: H4
Socket type: P43t
Socket type 2: P43t
Socket type 3: BA9s
Material: Rubber
Material/dome: Glass
Shape: Round
Sidemarker: w/
Asymmetric light: w/o
RH/LH: RH/LH
E-approval: Yes

SEALED BEAMS

4440X Sealed Beam

Servicing: Ford - Visit www.hc-cargo.com for further information

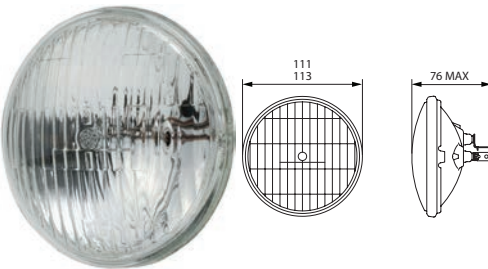

Bulb incl.: Yes 12 V
Voltage: 12
Watt: 40/40

Dim.: 113x76 mm

E-approval: No

H4360 Sealed Beam

Servicing: John Deere lawn equipment w/ cooling engine - Visit www.hc-cargo.com for further information

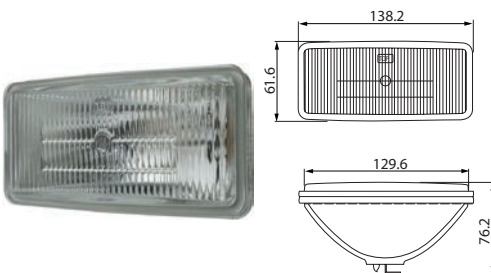

Bulb incl.: Yes 12 V
Voltage: 12
Watt: 37.5

Dim.: 138.2x61.6x76.2 mm

E-approval: No

H5360 Sealed Beam

Servicing: John Deere - Visit www.hc-cargo.com for further information

Longlife.

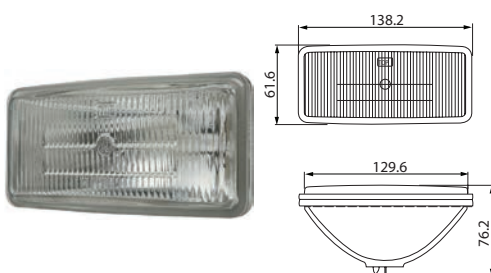

Bulb incl.: Yes 12 V
Voltage: 12
Watt: 37.5

Dim.: 138.2x61.6x76.2 mm

E-approval: No

AUXILLIARY LAMPS

170549 Fog Lamp

Light unit: HC-CARGO 170620.

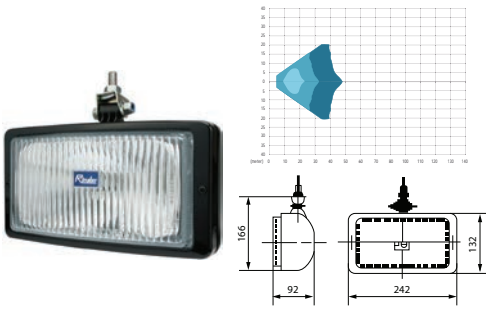

Bulb incl.: No
Watt: 55
Watt 2: 70

Dim.: 242x166x92 mm
Light aperture:
200x107 mm

Type: Fog light
Bulb type: H3
Bulb type 2: H3
Socket type: PK22s
Socket type 2: PK22s
Material: Metal
Material/dome: Glass
Shape: Rectangular
Asymmetric light: w/o
E-approval: Yes

170550 Driving Lamp

Light unit: HC-CARGO 170621.

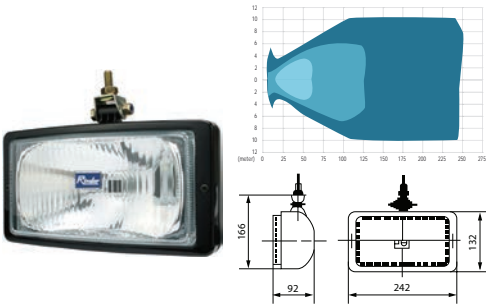

Bulb incl.: No
Watt: 55/70
Watt 2: 70

Dim.: 242x166x92 mm
Light aperture:
200x107 mm

Type: Driving lamp
Bulb type: H3
Bulb type 2: H3
Socket type: PK22s
Socket type 2: PK22s
Colour: Black
Material: Metal
Material/dome: Glass
Shape: Rectangular
Mount.: Mounted below
E-approval: Yes

170616 Fog Lamp

Light unit: HC-CARGO 170622.

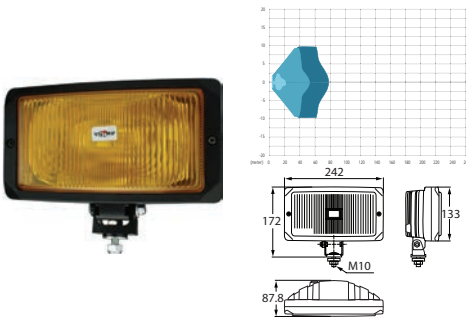

Bulb incl.: No
Watt: 55
Watt 2: 70

Dim.: 242x172x87.8 mm
Light aperture:
240x170 mm

Type: Fog light
Bulb type: H3
Bulb type 2: H3
Socket type: PK22s
Socket type 2: PKY22s
Colour: Yellow
Material: Metal
Material/dome: Glass
Shape: Rectangular
Mount.: Upright/pendant
E-approval: Yes

171359 Driving Lamp

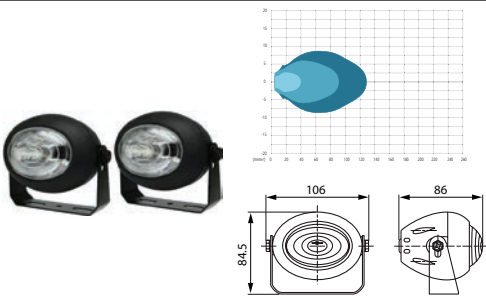

Bulb incl.: No
Watt: 55
Watt 2: 70

Dim.: 106x84.5x86 mm
Light aperture:
55x35 mm

Type: Driving lamp
Bulb type: H3
Bulb type 2: H3
Socket type: PK22s
Socket type 2: PK22s
Material: Shockproof plastic
Material/dome: Glass
Shape: Oval
Mount.: U-bracket w/ 2 holes
Asymmetric light: w/o
E-approval: No

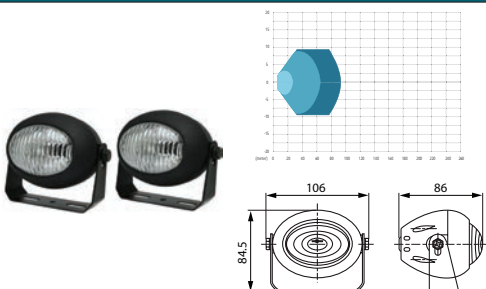

171360 Fog Lamp



Bulb incl.: No
Watt: 55
Watt 2: 70

Dim.: 106x84.5x86 mm
Light aperture:
55x35 mm

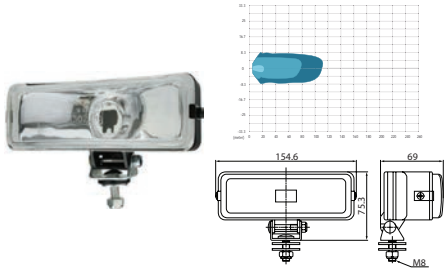
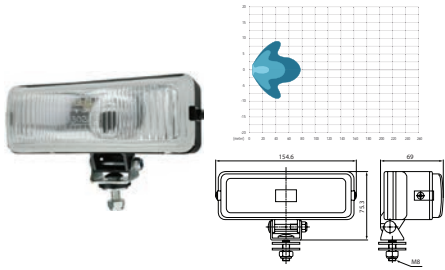
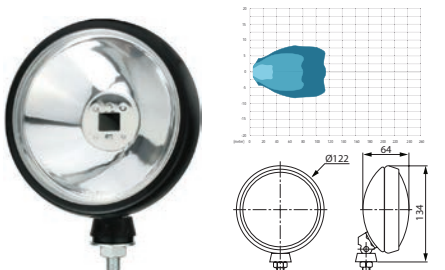
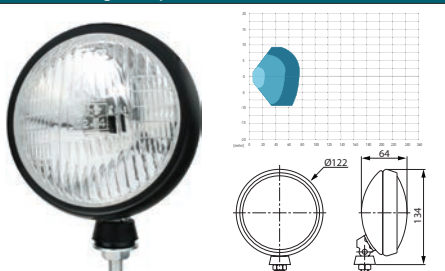
Type: Fog light
Bulb type: H3
Bulb type 2: H3
Socket type: PK22s
Socket type 2: PK22s
Material: Shockproof plastic
Material/dome: Glass
Shape: Oval
Mount.: U-bracket w/ 2 holes
E-approval: Yes

	EL. SPECIFICATIONS	DIMENSIONS	ADDITIONAL SPECIFICATIONS
171361 Driving Lamp	 <p>Bulb incl.: No Watt: 55 Watt 2: 70</p>	<p>Dim.: 154.6x75.3x69 mm Light aperture: 130x35 mm</p>	<p>Type: Driving lamp Bulb type: H3 Bulb type 2: H3 Socket type: PK22s Socket type 2: PK22s Material: Shockproof plastic Material/dome: Glass Shape: Rectangular Mount.: U-bracket w/ 1 bolt E-approval: No</p>
171362 Fog Lamp	 <p>Bulb incl.: No Watt: 55 Watt 2: 70</p>	<p>Dim.: 154.6x75.3x69 mm Light aperture: 130x35 mm</p>	<p>Type: Fog light Bulb type: H3 Bulb type 2: H3 Socket type: PK22s Socket type 2: PK22s Material: Shockproof plastic Material/dome: Glass Shape: Rectangular Mount.: U-bracket w/ 1 bolt E-approval: No</p>
171363 Driving Lamp	 <p>Bulb incl.: No Voltage: 12/24 Watt: 55 Watt 2: 70</p>	<p>Dim.: 122x134x64 mm Light aperture: 95 mm</p>	<p>Type: Driving lamp Bulb type: H3 Bulb type 2: H3 Socket type: PK22s Socket type 2: PK22s Colour: Black Material: Metal Material/dome: Glass Shape: Round Mount.: Mounted below E-approval: No</p>
171364 Fog Lamp	 <p>Bulb incl.: No Voltage: 12/24 Watt: 55/70 Watt 2: 70</p>	<p>Dim.: 122x134x64 mm Light aperture: 95 mm</p>	<p>Type: Fog light Bulb type: H3 Bulb type 2: H3 Socket type: PK22s Socket type 2: PK22s Colour: Black Material: Metal Material/dome: Glass Shape: Round Mount.: Mounted below E-approval: No</p>
171365 Driving Lamp	 <p>Bulb incl.: No Watt: 55 Watt 2: 70</p>	<p>Dim.: 156x105x56 mm Light aperture: 110x75 mm</p>	<p>Type: Driving lamp Bulb type: H3 Bulb type 2: H3 Socket type: PK22s Socket type 2: PK22s Colour: Black Material: Metal Material/dome: Glass Shape: Rectangular Mount.: Mounted below E-approval: Yes</p>
171366 Fog Lamp	 <p>Bulb incl.: No Watt: 55 Watt 2: 70</p>	<p>Dim.: 156x105x56 mm Light aperture: 110x75 mm</p>	<p>Type: Fog light Bulb type: H3 Bulb type 2: H3 Socket type: PK22s Socket type 2: PK22s Colour: Black Material: Metal Material/dome: Glass Shape: Rectangular Mount.: Mounted below E-approval: Yes</p>

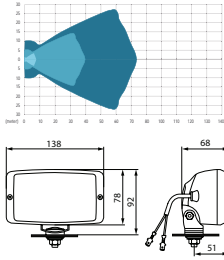
171451 Set of Driving Lamps

Bulb incl.: Yes
Voltage: 12
Watt: 55

Dim.: 138x78x68 mm
Light aperture:
110x60 mm

Type: Driving lamp
Bulb type: H3
Socket type: PK22s
Material: Shockproof plastic
Material/dome: Glass
Shape: Rectangular
Mount.: 1 bolt
Bracket: Pendant
E-approval: Yes

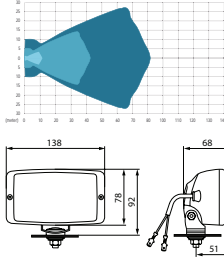
171452 Fog Lamp Set

Bulb incl.: Yes
Voltage: 12
Watt: 55

Dim.: 138x78x68 mm
Light aperture:
110x60 mm

Type: Fog light
Bulb type: H3
Socket type: PK22s
Material: Shockproof plastic
Material/dome: Glass
Shape: Rectangular
Mount.: Screw
Bracket: Pendant
E-approval: Yes

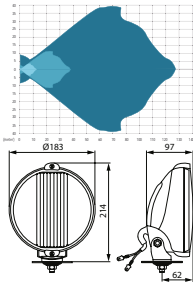
171597 Driving Lamp

Bulb incl.: No
Watt: 55/70
Watt 2: 4

Dim.: 183x214x97 mm
Light aperture: 180 mm

Type: Driving lamp
Bulb type: H3
Socket type: PK22s
Socket type 2: BA9s
Colour: Black
Material: Metal
Material/dome: Glass
Shape: Round
Mount.: Mounted below
Sidemarker: w/
E-approval: Yes

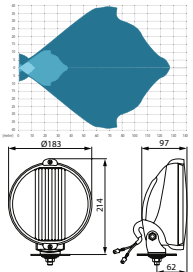
171598 Fog Lamp

Bulb incl.: No
Watt: 55/70
Watt 2: 4

Dim.: 183x214x97 mm
Light aperture: 180 mm

Type: Fog light
Bulb type: H3
Socket type: PK22s
Socket type 2: BA9s
Colour: Black
Material: Metal
Material/dome: Glass
Shape: Round
Mount.: Mounted below
Sidemarker: w/
E-approval: Yes

SPARE PARTS
170620 Light Unit

Servicing: HC-CARGO 170549

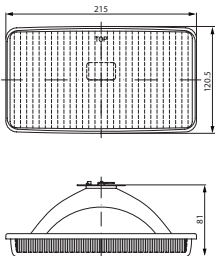

Bulb incl.: No
Watt: 55
Watt 2: 70

Dim.: 215x120.5x81 mm

Bulb type: H3
Bulb type 2: H3
Socket type: PK22s
Socket type 2: PK22s
Shape: Rectangular
Asymmetric light: w/o
E-approval: Yes

170621 Light Unit

Servicing: HC-CARGO 170550

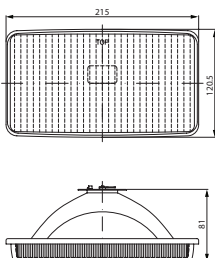

Bulb incl.: No
Watt: 55
Watt 2: 70

Dim.: 215x120.5x81 mm
Light aperture:
200x107 mm

Bulb type: H3
Bulb type 2: H3
Socket type: PK22s
Socket type 2: PK22s
Colour: Black
Material: Metal
Material/dome: Glass
Shape: Rectangular
Asymmetric light: w/o
E-approval: Yes

LED DAYTIME RUNNING LIGHT SETS

171739 Daytime Running Light

High beam 5 watt, low beam 0.5 watt.

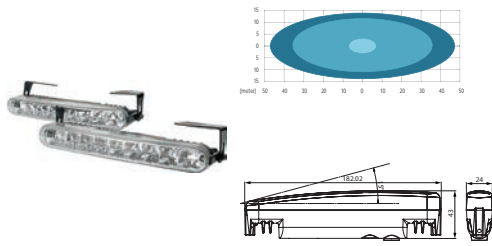

Voltage: 12/24
Watt: 6-5.8

Dim.: 180.02x24x43 mm
Cable length: 500 mm
Dist. mount. holes:
110 mm

Type: LED
Material: ABS plastic
Material/dome: PMMA
Shape: Rectangular
Mount.: Bracket
Bracket: Adjustable
No./lamps: 2
Fixing screw: 4
No./LEDs: 2x18
E-approval: Yes

171740 Daytime Running Light

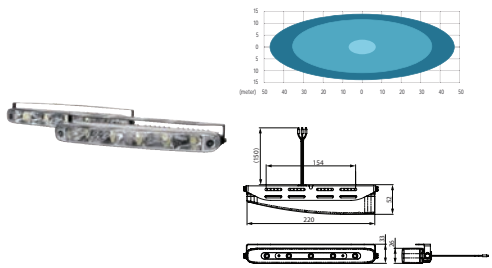

Voltage: 12/24
Watt: 2x5

Dim.: 220x33x26 mm
Cable length: 500 mm
Dist. mount. holes:
215 mm

Type: LED
Material: ABS plastic
Material/dome: PMMA
Shape: Rectangular
Mount.: Bracket
Bracket: Adjustable
No./lamps: 2
Fixing screw: 4
No./LEDs: 2x5
E-approval: Yes

171741 Daytime Running Light

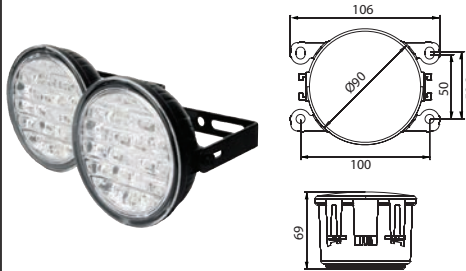

Voltage: 12/24
Watt: 4

Dim.: 90x69 mm
OD: 90 mm
Cable length: 500 mm
Dist. mount. holes:
40 mm
Light aperture: 73 mm

Type: LED
Material: ABS plastic
Material/dome: PMMA
Shape: Round
Mount.: Bracket
Bracket: Adjustable
No./lamps: 2
Fixing screw: 2
No./LEDs: 2x18
E-approval: Yes

POSITION LAMPS CONVENTIONAL

170875 Position Lamp

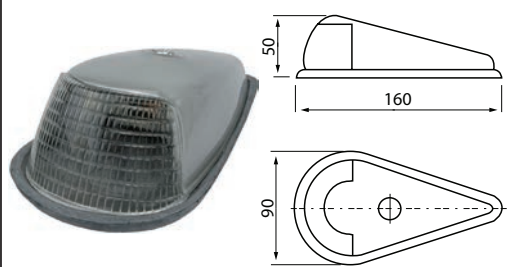

Voltage: 12/24
Watt: 5

Dim.: 160x59x45 mm
Dist. mount. holes:
57 mm

Colour/glass: White
Material: Plastic
Fixing screw: 2

170881 Position Lamp

Lens: HC-CARGO 170976.

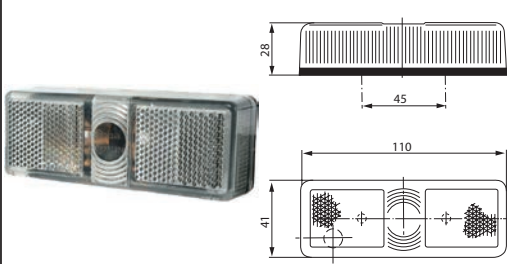

Watt: 5

Dim.: 110x41x28 mm
Dist. mount. holes:
45 mm

Socket type: S8.5
Colour/glass: White
Material: Shockproof plastic
Shape: Rectangular
Reflector: w/
Fixing screw: 2
Sidemarker lamp: w/
Tail light: w/
E-approval: Yes

170887 Position Lamp

Lens: HC-CARGO 170952.

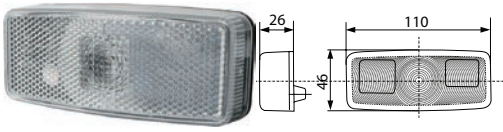

Watt: 5

 Dim.: 110x46x26 mm
 Dist. mount. holes:
 85 mm

 Socket type: T10
 Colour/glass: White
 Material: Shockproof plastic
 Shape: Rectangular
Reflector: w/
 Fixing screw: 2
 Sidemarker lamp: w/
 Tail light: w/
 E-approval: Yes

171171 Position Lamp

Lens: HC-CARGO 171238.



Watt: 5

 Dim.: 62x62x45 mm
 Dist. mount. holes:
 30 mm

 Socket type: S8.5
 Colour: Black
 Colour/glass: Transparent
 Material: Shockproof plastic
 Fixing screw: 2
 E-approval: Yes

171174 Position Lamp

Lens: HC-CARGO 171242.

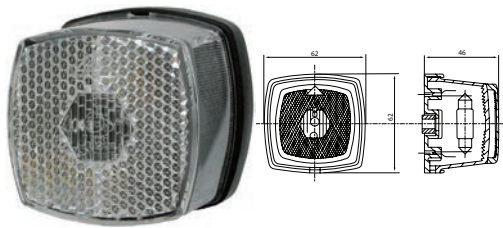

Watt: 5

 Dim.: 62x62x46 mm
 Dist. mount. holes:
 30 mm

 Socket type: S8.5
 Colour: Black
 Colour/glass: White
 Material: Shockproof plastic
 Shape: Square
Reflector: w/
 Fixing screw: 2
 E-approval: Yes

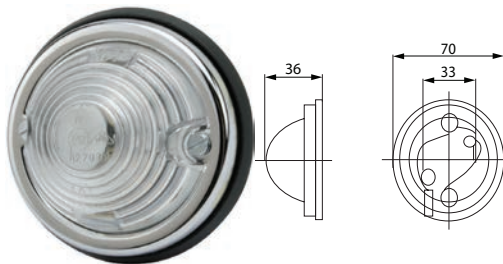
171179 Position Lamp

Watt: 5

 Dim.: 70x36 mm
 Dist. mount. holes:
 33 mm

 Type: Position lamp
 Socket type: S8.5
 Colour/glass: White
 Material: Steel
 Shape: Circular
 Fixing screw: 2
 E-approval: Yes

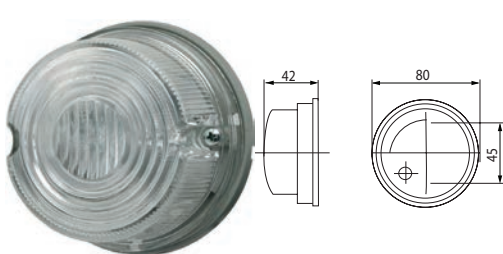
171182 Position Lamp

Watt: 5

 Dim.: 80x42 mm
 Dist. mount. holes:
 45 mm

 Type: Position lamp
 Socket type: S8.5
 Colour/glass: White
 Material: Shockproof plastic
 Shape: Circular
 Fixing screw: 2
 E-approval: Yes

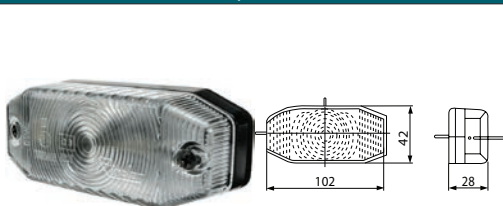
171332 Position Lamp



Watt: 5

 Dim.: 102x42x28 mm
 Dist. mount. holes:
 65 mm

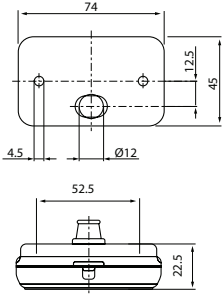
 Socket type: S8.5
 Colour: Black
 Colour/glass: White
 Material: Plastic
 Fixing screw: 2
 E-approval: Yes

	EL. SPECIFICATIONS	DIMENSIONS	ADDITIONAL SPECIFICATIONS
171493 Position Lamp  	Watt: 5	Dim.: 74x45x22.5 mm Dist. mount. holes: 52 mm	Socket type: S8.5 Colour: Black Colour/glass: White Material: Plastic Shape: Rectangular Reflector: w/ Fixing screw: 2 E-approval: Yes

SPARE PARTS

170952 Lens 	Servicing: HC-CARGO 170887	Dim.: 110x46x26 mm	
---	-----------------------------------	---------------------------	--

170976 Lens 	Servicing: HC-CARGO 170881	Dim.: 110x41x28 mm	Shape: Rectangular
--	-----------------------------------	---------------------------	---------------------------

171242 Lens 	Servicing: HC-CARGO 171174	Dim.: 62x62x46 mm	Shape: Square
---	-----------------------------------	--------------------------	----------------------

POSITION LAMPS LED

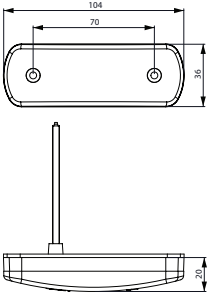
171583 LED Position Lamp  	Voltage: 12 Watt: 0.49	Dim.: 104x36x20 mm Cable length: 500 mm Dist. mount. holes: 70 mm	Type: LED Colour/glass: White Material: Shockproof plastic Reflector: w/ Fixing screw: 2 Sidemarkers: w/ No./LEDs: 1 E-approval: Yes
--	---	--	---

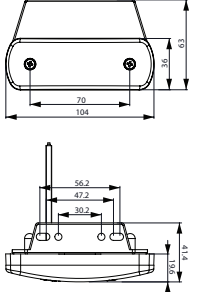
171584 LED Position Lamp  	Voltage: 12 Watt: 0.49	Dim.: 104x36x19.6 mm Cable length: 500 mm Dist. mount. holes: 52 mm	Type: LED Colour/glass: White Material: Shockproof plastic Bracket: Angled Reflector: w/ Fixing screw: 2 Sidemarkers: w/ No./LEDs: 1 E-approval: Yes
--	---	--	---

ACCESSORIES - Lighting

O.E.M. names and numbers are used for reference purposes only.

171603 LED Position Lamp

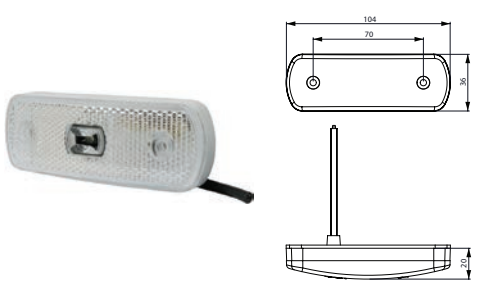

Voltage: 24
Watt: 1.02

Dim.: 104x36x20 mm
Cable length: 500 mm
Dist. mount. holes:
70 mm

Type: LED
Colour/glass: White
Material: Shockproof plastic
Shape: Rectangular
Reflector: w/
Fixing screw: 2
Sidemarker: w/
No./LEDs: 1
Approvals: ADR
E-approval: Yes

171604 LED Position Lamp

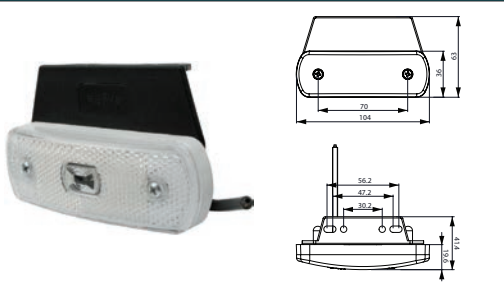

Voltage: 24
Watt: 1.02

Dim.: 104x36x19.6 mm
Cable length: 500 mm
Dist. mount. holes:
52 mm

Type: LED
Colour/glass: White
Material: Shockproof plastic
Bracket: Angled
Reflector: w/
Fixing screw: 2
Sidemarker: w/
No./LEDs: 1
Approvals: ADR
E-approval: Yes

171609 LED Position Lamp

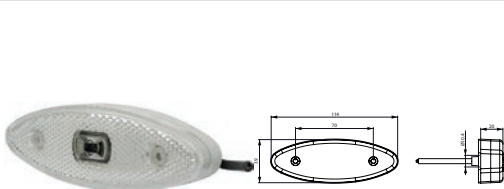

Voltage: 24
Watt: 0.44

Dim.: 114x39x20 mm
Cable length: 500 mm
Dist. mount. holes:
70 mm

Type: LED
Colour/glass: White
Material: Shockproof plastic
Reflector: w/
Fixing screw: 2
Sidemarker: w/
No./LEDs: 1
E-approval: Yes

171610 LED Position Lamp

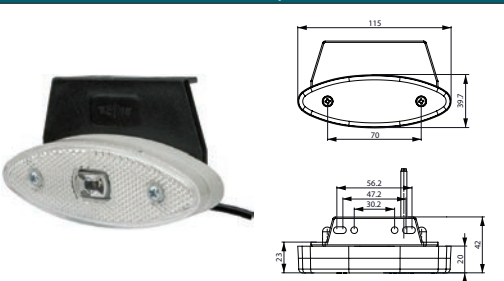

Voltage: 24
Watt: 0.44

Dim.: 115x39.7x20 mm
Cable length: 500 mm
Dist. mount. holes:
70 mm

Type: LED
Colour/glass: White
Material: Shockproof plastic
Shape: Oval
Bracket: Angled
Reflector: w/
Fixing screw: 2
Sidemarker: w/
No./LEDs: 1
E-approval: Yes

171638 LED Position Lamp

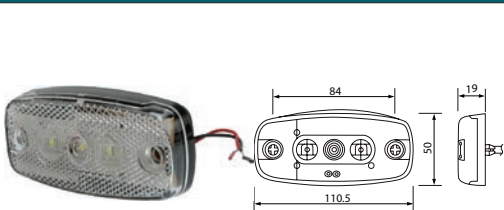

Voltage: 9-36
Watt: 0.9

Dim.: 110.5x50x19 mm
Dist. mount. holes:
83 mm

Type: LED
Colour/glass: White
Reflector: w/
Sidemarker: w/
No./LEDs: 3
Approvals: ADR
E-approval: Yes



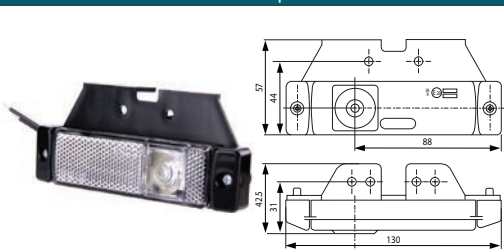





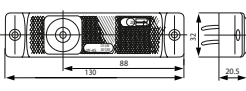

171717 LED Position Lamp

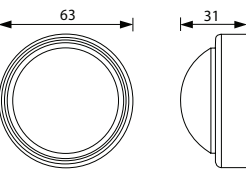

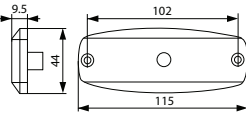
Voltage: 12/24
Watt: 0.4/0.8

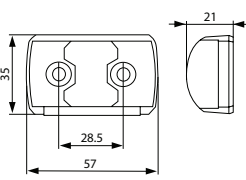
Dim.: 130x57x42.5 mm

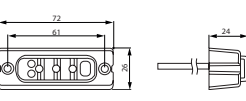
Type: LED
Socket type: LED
Colour/glass: White
Material: Shockproof plastic
Bracket: Angled
Reflector: w/
Sidemarker: w/
No./LEDs: 1
E-approval: Yes

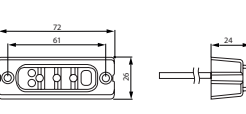
	EL. SPECIFICATIONS	DIMENSIONS	ADDITIONAL SPECIFICATIONS
171718 LED Position Lamp	 	Voltage: 12/24 Watt: 0.4/0.8 Dim.: 130x32x20.5 mm	Type: LED Socket type: LED Colour/glass: White Material: Shockproof plastic Reflector: w/ Sidemarker: w/ No./LEDs: 1 E-approval: Yes
171744 LED Position Lamp	 	Voltage: 9-36 Dim.: 63x31 mm OD: 63 mm Cable length: 300 mm Dist. mount. holes: 30 mm	Type: LED Colour: Black Colour/glass: Transparent Material: PVC Material/dome: PMMA Shape: Round Mount.: 2 screws Sidemarker: w/ No./LEDs: 3 Approvals: ADR/SAE E-approval: Yes
171841 LED Position Lamp	 	Voltage: 12/24 Watt: 0.45-1.6 Dim.: 115x44x9.5 mm Cable length: 5000 mm Dist. mount. holes: 102 mm	Type: LED Colour: White Colour/glass: White Material: Polycarbonate Material/dome: Polycarbonate Shape: Rectangular Mount.: 2 screws Reflector: w/ Sidemarker: w/ No./LEDs: 3 Tightness norm: IP 67 Approvals: SAE E-approval: Yes
171844 LED Position Lamp	 	Voltage: 12/24 Dim.: 57x35x21 mm Cable length: 400 mm Dist. mount. holes: 28 mm	Type: LED Colour: Black Colour/glass: White Shape: Rectangular Fixing screw: 2 Sidemarker: w/ No./LEDs: 2 Tightness norm: IP 67 E-approval: Yes
171862 LED Position Lamp	 	Voltage: 12/24 Watt: 0.3-0.6 Dim.: 72x26x24 mm Cable length: 5000 mm Dist. mount. holes: 61 mm	Type: LED Colour: Black Colour/glass: White Material: PP Material/dome: PMMA Shape: Rectangular Sidemarker lamp: w/ No./LEDs: 3 Approvals: CE E-approval: Yes
171868 LED Position Lamp	 	Voltage: 12/24 Watt: 0.3-0.6 Dim.: 72x26x24 mm Cable length: 5000 mm Dist. mount. holes: 61 mm	Type: LED Colour: Black Colour/glass: White Material: PP Material/dome: PMMA Shape: Rectangular Bracket: Adjustable Sidemarker lamp: w/ No./LEDs: 3 Approvals: CE E-approval: Yes

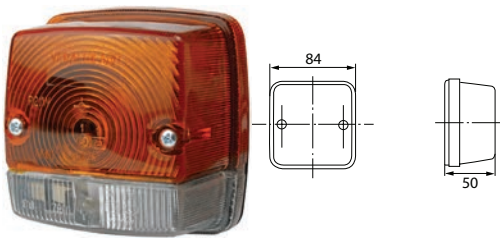
FLASHER-POSITION LAMPS CONVENTIONAL
170925 Flasher/Position Lamp

 Watt: 21
Watt 2: 5

 Dim.: 84x50 mm
Dist. mount. holes:
45 mm

 Socket type: BA15S
Socket type 2: S8.5
Material: Shockproof plastic
Shape: Square
Fixing screw: 2
RH/LH: RH/LH
E-approval: Yes

170927 Flasher/Position Lamp

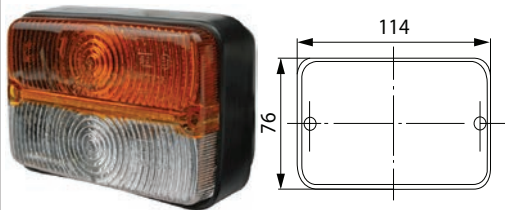
Lens: HC-CARGO 170989.

 Watt: 21
Watt 2: 5

 Dim.: 114x76 mm
Dist. mount. holes:
58 mm

 Socket type: BA15S
Socket type 2: BA15S
Material: Shockproof plastic
Shape: Rectangular
Fixing screw: 2
RH/LH: RH/LH
E-approval: Yes

170941 Flasher/Position Lamp

Servicing: HC-CARGO 170828

Lens: HC-CARGO 170834.

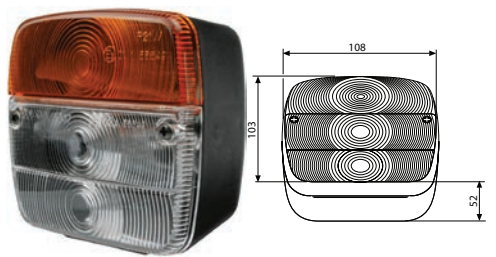

 Watt: 21
Watt 2: 5

 Dim.: 108x103x52 mm
Dist. mount. holes:
55 mm

 Socket type: BA15S
Socket type 2: S8.5
Material: Shockproof plastic
Shape: Rectangular
Fixing screw: 2
Flasher light: w/
Sidemarker: w/
RH/LH: RH/LH
E-approval: Yes

171215 Flasher/Position Lamp

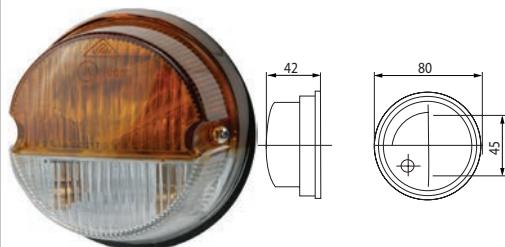
Lens: HC-CARGO 171248.



 Watt: 18
Watt 2: 10

 Dim.: 80x42 mm
Dist. mount. holes:
45 mm

 Socket type: S8.5
Socket type 2: S8.5
Material: Metal
Shape: Circular
Fixing screw: 2
RH/LH: RH/LH
E-approval: Yes

171217 Flasher/Position Lamp

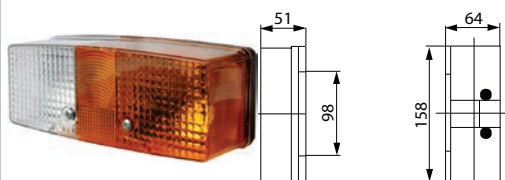
Right: HC-CARGO 171260.



 Watt: 21
Watt 2: 5

 Dim.: 158x64x51 mm
Dist. mount. holes:
98/45 mm

 Socket type: BA15S
Socket type 2: BA15S
Material: Shockproof plastic
Shape: Rectangular
Fixing screw: 4
RH/LH: LH
E-approval: Yes

171218 Flasher/Position Lamp

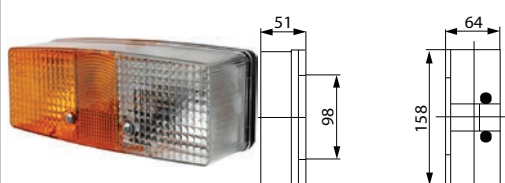
Left: HC-CARGO 171217.



 Watt: 21
Watt 2: 5

 Dim.: 158x64x51 mm
Dist. mount. holes:
98/45 mm

 Socket type: BA15S
Socket type 2: BA15S
Material: Shockproof plastic
Shape: Rectangular
Fixing screw: 4
RH/LH: RH
E-approval: Yes

171510 Flasher/Position Lamp

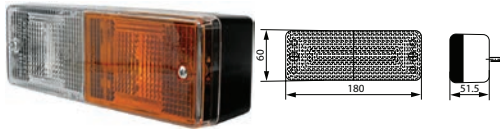
Lens: HC-CARGO 171510.



Watt: 21
Watt 2: 5

Dim.: 180x60x51.5 mm
Dist. mount. holes:
134 mm

Socket type: BA15S
Socket type 2: BA15S
Material: Shockproof plastic
Shape: Rectangular
Fixing screw: 2
RH/LH: RH/LH
E-approval: Yes

SPARE PARTS

170834 Lens, Rear Lamp

Servicing: HC-CARGO 170941



Dim.: 108x103x52 mm

Shape: Rectangular
Fixing screw: 2
Flasher light: w/
Sidemarker: w/

170989 Lens

Servicing: HC-CARGO 170927



Dim.: 114x76 mm

Shape: Rectangular

FLASHER-POSITION LAMPS LED

171800 LED Flasher/Positions Lamp

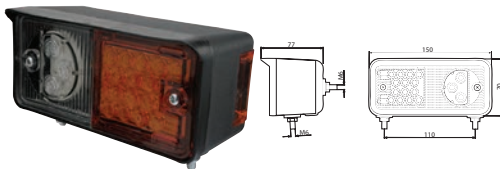

Voltage: 12/24

Dim.: 150x70x77 mm
Cable length: 2100 mm
Dist. mount. holes:
110/55 mm

Colour: Black
Material: Shockproof plastic
Shape: Rectangular
Mount.: Upright/pendant
Fixing screw: 2
No./LEDs: 14/3
RH/LH: LH
E-approval: Yes

171801 LED Flasher/Positions Lamp

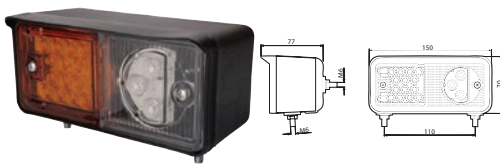

Voltage: 12/24

Dim.: 150x70x77 mm
Cable length: 2100 mm
Dist. mount. holes:
110/55 mm

Colour: Black
Material: Shockproof plastic
Shape: Rectangular
Mount.: Upright/pendant
Fixing screw: 2
No./LEDs: 14/3
RH/LH: RH
E-approval: Yes

SIDE INDICATORS CONVENTIONAL

170713 Flasher Lamp











Lens: HC-CARGO 170670, 170671.

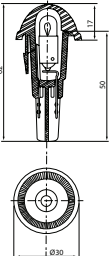

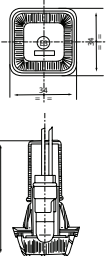
Watt: 5

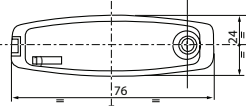
Dim.: 108x84x93 mm
OD: 60 mm

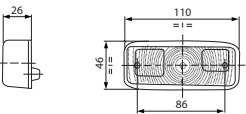
Socket type: BA15S
Colour/glass: Orange
E-approval: Yes

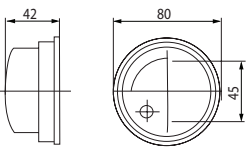
	EL. SPECIFICATIONS	DIMENSIONS	ADDITIONAL SPECIFICATIONS
171140 Flasher Lamp 	Servicing: Fiat, Ford, Lada, Universal - Visit www.hc-cargo.com for further information	OD: 27 mm Dist. mount. holes: 28 mm	Socket type: BA9s Colour/glass: Orange E-approval: Yes
171141 Flasher Lamp  	Servicing: Fiat 127, 129 - Visit www.hc-cargo.com for further information	OD: 30 mm Dim.: 62x50x17 mm Dist. mount. holes: 28 mm	Colour/glass: Orange E-approval: Yes
171147 Flasher Lamp  	Servicing: Ford, Universal - Visit www.hc-cargo.com for further information	Dim.: 34x34x60 mm	Colour/glass: Orange E-approval: Yes
171148 Flasher Lamp  	Servicing: Universal, Ford, Rover Group - Visit www.hc-cargo.com for further information	Dim.: 76x24 mm	Socket type: BA9s Colour/glass: Orange E-approval: Yes
171153 Flasher Lamp  	Servicing: Audi, VW, various types 84 - Visit www.hc-cargo.com for further information	Dim.: 110x46x26 mm Dist. mount. holes: 86 mm	Type: Flasher lamp Colour: Orange Colour/glass: Orange Material: Plastic Material/dome: Plastic Shape: Flat Mount.: Sidemounted No./lamps: 1 Flasher light: w/ RH/LH: RH/LH E-approval: Yes
171183 Flasher Lamp Lens: HC-CARGO 171247.  	Watt: 5	Dim.: 80x42 mm Dist. mount. holes: 45 mm	Socket type: S8.5 Colour/glass: Orange Material: Shockproof plastic Fixing screw: 2 E-approval: Yes

EL. SPECIFICATIONS		DIMENSIONS	ADDITIONAL SPECIFICATIONS
171337 Flasher Lamp			
 	Watt: 10	Dim.: 95x73x83 mm Dist. mount. holes: 48 mm	Socket type: BA15S Colour: Black Colour/glass: Orange Material: Plastic Shape: Rectangular Fixing screw: 2 E-approval: Yes
171339 Flasher Lamp			
	Watt: 21	Dim.: 84x84x51 mm Dist. mount. holes: 45 mm	Socket type: BA15S Colour/glass: Orange Material: Plastic Shape: Rectangular Fixing screw: 2 E-approval: Yes
SPARE PARTS			
170670 Lens		Servicing: HC-CARGO 170713	
			Colour/glass: Orange Material: Glass
170671 Bulb Holder		Servicing: HC-CARGO 170640, 170668, 170713	
			
SIDE INDICATORS LED			
171770 LED Flasher Lamp			
 	Voltage: 24 Watt: 4	Dim.: 162x113x50 mm	Type: Flasher lamp Colour/glass: Orange Material: ABS plastic Material/dome: PMMA Shape: Rectangular Mount.: Plan installation Flasher light: w/ No./LEDs: 16 RH/LH: RH/LH E-approval: Yes
SIDE MARKER LAMPS CONVENTIONAL			
170880 Side Marker Lamp			
Lens: HC-CARGO 170975.			
 	Watt: 5	Dim.: 110x41x28 mm Dist. mount. holes: 45 mm	Socket type: S8.5 Colour: Black Colour/glass: Orange Material: Shockproof plastic Shape: Rectangular Reflector: w/ Fixing screw: 2 E-approval: Yes

170884 Side Marker Lamp

Lens: HC-CARGO 170946.

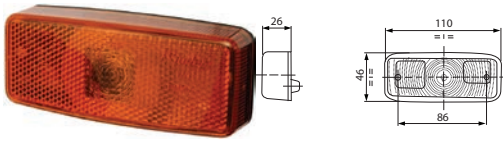

Watt: 5

 Dim.: 110x46x26 mm
 Dist. mount. holes:
 85 mm

 Socket type: T10
 Colour/glass: Orange
 Material: Shockproof plastic
 Shape: Rectangular
Reflector: w/
 Fixing screw: 2
 E-approval: Yes

170885 Side Marker Lamp

Lens: HC-CARGO 170946.

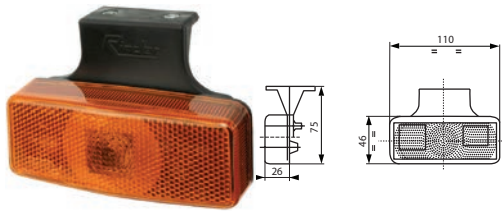

Watt: 5

 Dim.: 110x46x26 mm
 Dist. mount. holes:
 20/50 mm

 Socket type: T10
 Colour/glass: Orange
 Material: Shockproof plastic
 Shape: Rectangular
 Bracket: Angled
Reflector: w/
 E-approval: Yes

171175 Side Marker Lamp

Lens: HC-CARGO 171243.

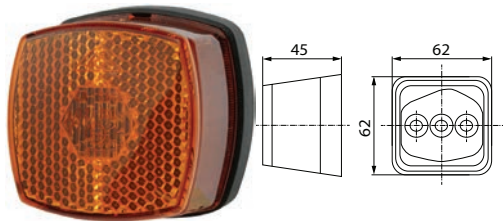

Watt: 5

 Dim.: 62x62x45 mm
 Dist. mount. holes:
 30 mm

 Socket type: S8.5
 Colour: Black
 Colour/glass: Orange
 Material: Shockproof plastic
Reflector: w/
 Fixing screw: 2
 E-approval: Yes

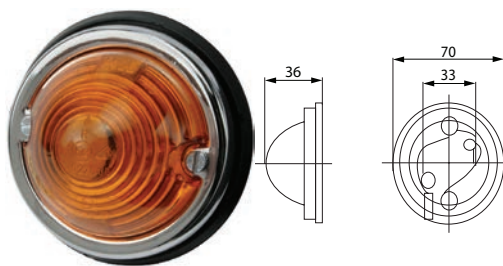
171180 Side Marker Lamp

Watt: 5

 Dim.: 70x36 mm
 Dist. mount. holes:
 33 mm

 Type: Side marker lamp
 Socket type: S8.5
 Colour/glass: Orange
 Material: Steel
 Fixing screw: 2
 E-approval: Yes

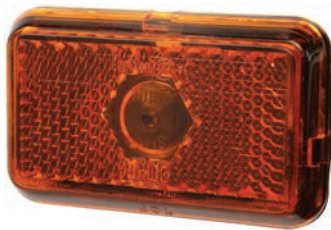
171343 Side Marker Lamp

Watt: 5

 Dim.: 74x45x22.5 mm
 Dist. mount. holes:
 52 mm

 Socket type: S8.5
 Colour: Black
 Colour/glass: Orange
 Material: Plastic
 Shape: Rectangular
 Fixing screw: 2
 E-approval: Yes

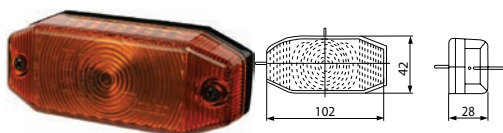
171369 Side Marker Lamp

Watt: 5

 Dim.: 102x42x28 mm
 Dist. mount. holes:
 65 mm

 Socket type: S8.5
 Colour: Black
 Colour/glass: Orange
 Material: Plastic
 Fixing screw: 2
 E-approval: Yes

SPARE PARTS

170946 Lens

Servicing: HC-CARGO 170885



Dim.: 110x46 mm

170975 Lens

Servicing: HC-CARGO 170880



Dim.: 110x41 mm

ACCESSORIES

171417 Angle Bracket

Long.

 Mount hole: 45 mm
Mount. hole 2: 85 mm

171419 Angle Bracket

Short.

 Mount hole: 45 mm
Mount. hole 2: 85 mm

SIDE MARKER LAMPS LED

171581 LED Side Marker Lamp

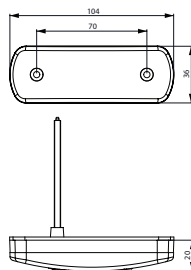

Voltage: 12

 Dim.: 104x36x20 mm
Cable length: 500 mm
Dist. mount. holes:
70 mm

 Type: LED
Colour/glass: Orange
Material: Shockproof plastic
Shape: Rectangular
Bracket: Angled
Reflector: w/
Fixing screw: 2
Sidemarker lamp: w/
No./LEDs: 1
E-approval: Yes

171582 LED Side Marker Lamp

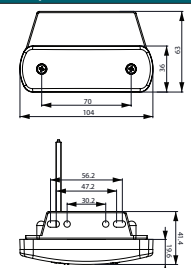

Voltage: 12

 Dim.: 104x36x19.6 mm
Cable length: 500 mm
Dist. mount. holes:
70 mm

 Type: LED
Colour/glass: Orange
Material: Shockproof plastic
Shape: Rectangular
Bracket: Angled
Reflector: w/
Fixing screw: 2
Sidemarker lamp: w/
No./LEDs: 1
E-approval: Yes

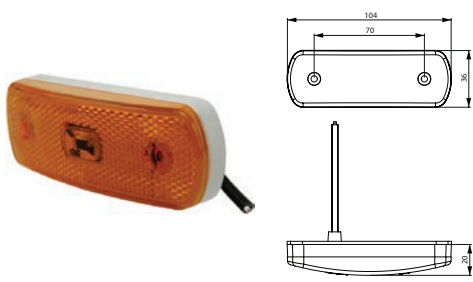
171601 LED Side Marker Lamp

Voltage: 24

 Dim.: 104x36x20 mm
 Cable length: 500 mm
 Dist. mount. holes:
 70 mm

 Type: LED
 Colour/glass: Orange
 Material: Shockproof plastic
 Shape: Rectangular
 Reflector: w/
 Fixing screw: 2
 Sidemarker lamp: w/
 No./LEDs: 1
 Approvals: ADR
 E-approval: Yes

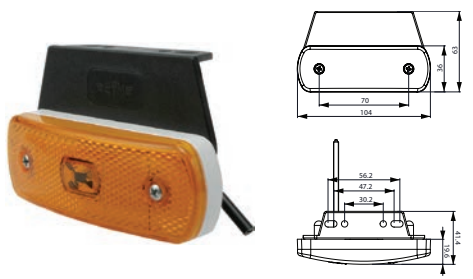
171602 LED Side Marker Lamp

Voltage: 24

 Dim.: 104x36x19.6 mm
 Cable length: 500 mm
 Dist. mount. holes:
 70 mm

 Type: LED
 Colour/glass: Orange
 Material: Shockproof plastic
 Shape: Rectangular
 Bracket: Angled
 Reflector: w/
 Fixing screw: 2
 Sidemarker lamp: w/
 No./LEDs: 1
 Approvals: ADR
 E-approval: Yes

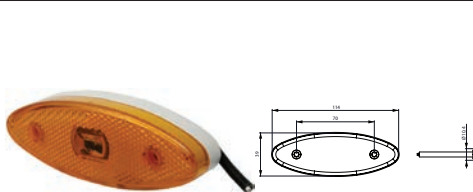
171607 LED Side Marker Lamp

Voltage: 24

 Dim.: 114x39x20 mm
 Cable length: 500 mm
 Dist. mount. holes:
 70 mm

 Type: LED
 Colour/glass: Orange
 Material: Shockproof plastic
 Reflector: w/
 Fixing screw: 2
 Sidemarker lamp: w/
 No./LEDs: 1
 E-approval: Yes

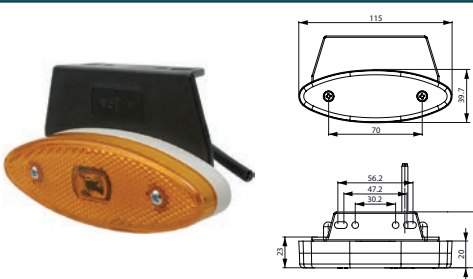
171608 LED Side Marker Lamp

Voltage: 24

 Dim.: 115x39.7x20 mm
 Dist. mount. holes:
 70 mm

 Type: LED
 Colour/glass: Orange
 Material: Shockproof plastic
 Shape: Oval
 Bracket: Angled
 Reflector: w/
 Fixing screw: 2
 Sidemarker lamp: w/
 No./LEDs: 1
 E-approval: Yes

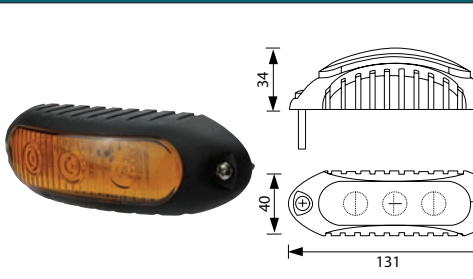
171618 LED Side Marker Lamp

Voltage: 9-36

 Dim.: 131x40x34 mm
 Cable length: 28 mm
 Dist. mount. holes:
 115 mm

 Type: LED
 Colour: Yellow
 Colour/glass: Orange
 Material: PP/PMMA
 Material/dome: ABS plastic
 Mount.: Screw fastening
 No./lamps: 1
 Fixing screw: 2
 Sidemarker lamp: w/
 No./LEDs: 3
 Wiring system: w/
 E-approval: Yes

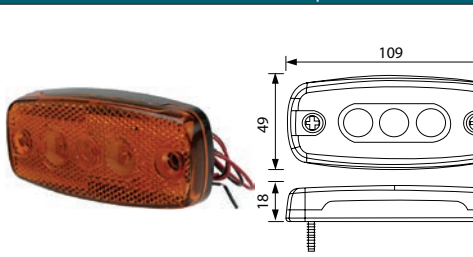
171636 LED Side Marker Lamp

 Voltage: 9-36
 Watt: 0.9

 Dim.: 109x49x18 mm
 Dist. mount. holes:
 83 mm

 Type: LED
 Colour/glass: Orange
 Shape: Rectangular
 Reflector: w/
 Sidemarker lamp: w/
 No./LEDs: 3
 E-approval: Yes

	EL. SPECIFICATIONS	DIMENSIONS	ADDITIONAL SPECIFICATIONS
<p>171721 LED Side Marker Lamp</p>	<p>Voltage: 12/24</p>	<p>Dim.: 130x57x42.5 mm Dist. mount. holes: 50 mm</p>	<p>Type: LED Socket type: LED Material: Shockproof plastic Shape: Rectangular Bracket: Angled Reflector: w/ Sidemarker lamp: w/ No./LEDs: 1 E-approval: Yes</p>
<p>171722 LED Side Marker Lamp</p>	<p>Voltage: 12/24</p>	<p>Dim.: 111x50.5x23 mm Dist. mount. holes: 116 mm</p>	<p>Type: LED Socket type: LED Colour/glass: Orange Material: Shockproof plastic Shape: Rectangular Mount.: Flat w/ 2 fixing holes Reflector: w/ Fixing screw: 2 Sidemarker lamp: w/ No./LEDs: 1 E-approval: Yes</p>
<p>171729 LED Side Marker Lamp</p>	<p>Voltage: 12/24 Watt: 1</p>	<p>Dim.: 65x65x28 mm Dist. mount. holes: 30 mm</p>	<p>Service: MAN - Visit www.hc-cargo.com for further information</p> <p>Type: LED Colour/glass: Orange Material: ABS plastic Material/dome: PMMA Shape: Square Bracket: Angled Reflector: w/ Sidemarker lamp: w/ No./LEDs: 2 E-approval: Yes</p>
<p>171735 LED Side Marker Lamp</p>	<p>Voltage: 12</p>	<p>Dim.: 110x41x19.6 mm Cable length: 200 mm Dist. mount. holes: 75 mm</p>	<p>Type: LED Shape: Rectangular Sidemarker lamp: w/ No./LEDs: 1 E-approval: Yes</p>
<p>171736 LED Side Marker Lamp</p>	<p>Voltage: 24</p>	<p>Dim.: 110x41x19.6 mm Cable length: 20 mm Dist. mount. holes: 75 mm</p>	<p>Type: LED Shape: Rectangular Sidemarker lamp: w/ No./LEDs: 1 E-approval: Yes</p>
<p>171742 LED Side Marker Lamp</p>	<p>Voltage: 12/24</p>	<p>Dim.: 63x31 mm OD: 63 mm Cable length: 300 mm</p>	<p>Type: LED Colour: Black Colour/glass: Orange Material: PVC Material/dome: PMMA Mount.: 2 screws Sidemarker lamp: w/ No./LEDs: 3 Approvals: ADR/SAE E-approval: Yes</p>

171835 LED Adapter

Servicing: HC-CARGO 171836, 193119

HC-CARGO 171835 is the LED version of HC-CARGO 170763.

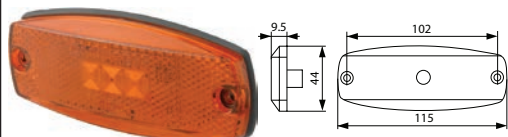

Voltage: 12/24

171839 LED Side Marker Lamp

 Voltage: 12/24
Watt: 0.45-1.6

 Dim.: 115x44x9.5 mm
Cable length: 5000 mm
Dist. mount. holes: 102 mm

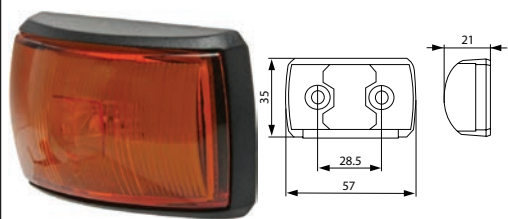
 Type: LED
Colour: White
Colour/glass: Orange
Material: Polycarbonate
Material/dome: Polycarbonate
Shape: Rectangular
Mount.: 2 screws
Reflector: w/
Sidemarker lamp: w/
No./LEDs: 3
Tightness norm: IP 67
Approvals: SAE
E-approval: Yes

171842 LED Side Marker Lamp

Voltage: 12/24

 Dim.: 57x35x21 mm
Cable length: 400 mm
Dist. mount. holes: 28.5 mm

 Type: LED
Colour: Black
Colour/glass: Orange
Material: ASA plastic
Material/dome: PMMA
Shape: Rectangular
Fixing screw: 2
Sidemarker lamp: w/
No./LEDs: 2
Tightness norm: IP 67
E-approval: Yes

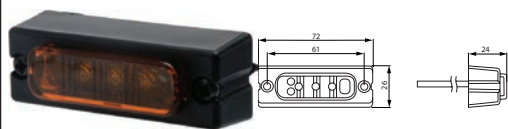
171860 LED Side Marker Lamp

 Voltage: 12/24
Watt: 0.3-0.6

 Dim.: 72x26x24 mm
Cable length: 5000 mm
Dist. mount. holes: 61 mm

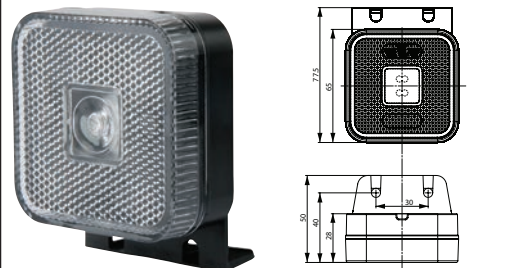
 Type: LED
Colour: Black
Colour/glass: Orange
Material: PP
Material/dome: PMMA
Shape: Rectangular
Fixing screw: 2
Sidemarker: w/
No./LEDs: 3
Approvals: CE
E-approval: Yes

171956 LED Side Marker Lamp

 Voltage: 12-24
Watt: 1

 Dim.: 65x65x28 mm
Cable length: 220 mm
Dist. mount. holes: 30 mm

 Type: LED
Colour/glass: White
Material: ABS plastic
Material/dome: PMMA
Shape: Square
Bracket: Angled
Reflector: w/
Sidemarker lamp: w/
No./LEDs: 2
Tightness norm: IP 68
E-approval: Yes

ACCESSORIES
171639 Angle Bracket

Servicing: HC-CARGO 171636, 171637, 171638



EL. SPECIFICATIONS	DIMENSIONS	ADDITIONAL SPECIFICATIONS
171836 Lens Servicing: HC-CARGO 171835		
	Dim.: 120x44.7x10 mm	Shape: Square E-approval: Yes
193119 Junior Power Timer Connector Servicing: HC-CARGO 171835, 171836		
<i>Terminal: HC-CARGO 192175, 192176, 192177, 192178, 192179.</i>		
		Type/terminal: Junior Power Timer Colour: Black No./poles: 2 Plug: Female
<h2>TAIL LIGHTS</h2>		
<h3>REVERSING LAMPS CONVENTIONAL</h3>		
170689 Reversing Lamp		
	Watt: 21 Dim.: 129x75x55 mm Dist. mount. holes: 56 mm	Socket type: BA15S Shape: Rectangular Bracket: Straight Fixing screw: 1 Reverse light: w/
170932 Reversing Lamp		
	Watt: 21 Dim.: 102x95x55 mm Dist. mount. holes: 77 mm	Socket type: BA15S Colour: Black Material: Shockproof plastic Shape: Rectangular Fixing screw: 2 Reverse light: w/ Approvals: CE
170934 Reversing Lamp		
	Watt: 21 Dim.: 140x90 mm Dist. mount. holes: 45 mm	Socket type: BA15S Colour: Black Material: Shockproof plastic Shape: Round Fixing screw: 2 Reverse light: w/ Wiring system: w/ E-approval: Yes
170935 Reversing Lamp		
	Watt: 21 Dim.: 125x84x68 mm	Socket type: BA15S Colour: Black Material: Shockproof plastic Shape: Rectangular Bracket: Pendant Fixing screw: M10 Reverse light: w/ E-approval: Yes

171222 Reversing Lamp



Bulb incl.: No
Voltage: 12/24
Watt: 55
Watt 2: 70

Dim.: 140x90 mm
Dist. mount. holes:
45 mm

Bulb type: H3
Bulb type 2: H3
Socket type: PK22s
Socket type 2: PK22s
Colour: Black
Material: Shockproof plastic
Shape: Circular
Fixing screw: 2
Wiring system: w/
E-approval: Yes

REVERSING LAMPS LED
170909 LED Fog/Reverse Lamp

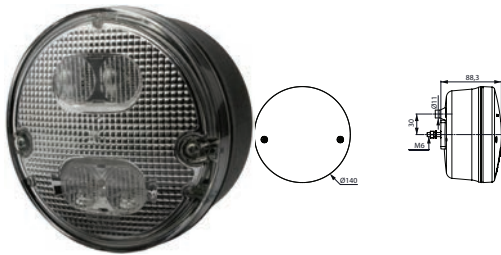
Lens and o-ring: HC-CARGO 170910.



Voltage: 12/24

Dim.: 140x88.3 mm
Dist. mount. holes:
45 mm

Type: LED
Colour/glass: White
Material: Shockproof plastic
Shape: Round
Fixing screw: 2
Rear/fog lamp: w/
Tail light: w/
LEDs: w/
No./LEDs: 4
E-approval: Yes

171684 LED Reversing Lamp

Can be flush mounted by using HC-CARGO 171266.

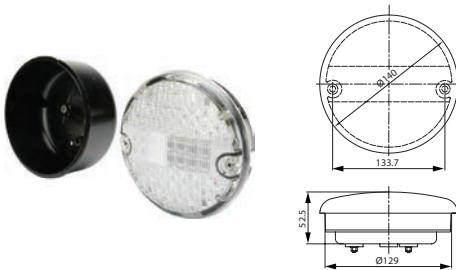

Voltage: 9-33
Watt: 8

Dim.: 140x52.5 mm
Dist. mount. holes:
45 mm

Type: Reversing lamp
Colour: Transparent
Material: Shockproof plastic
Shape: Circular
No./LEDs: 61
Approvals: ECE R23
E-approval: Yes

171726 LED Fog/Reverse Lamp

Ring: clear, center: red.



Voltage: 12/24

Dim.: 122x84.5 mm
Cable length: 150 mm
Dist. mount. holes:
44 mm

Type: LED
Material: Shockproof plastic
Material/dome: Shockproof plastic
Rear/fog lamp: w/
Reverse light: w/
No./LEDs: 38
E-approval: Yes

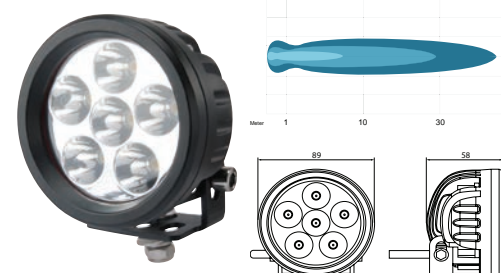
172007 LED Reversing Lamp

Voltage: 10-30
Watt: 18

Dim.: 89x58 mm

Type: Reversing lamp
Bulb type: 6 LED
Material: Cast aluminum
Material/dome: Polycarbonate
Shape: Round
Reverse light: w/
Tightness norm: IP 67
Approvals: ECE R23
E-approval: Yes

SPARE PARTS			
170910 Lens, Rear Lamp		Servicing: HC-CARGO 170909	
		OD: 140 mm Dist. mount. holes: 111 mm	Colour: White Shape: Round
REAR FOG LAMPS CONVENTIONAL			
170688 Rear Fog Lamp		Watt: 21	Dim.: 129x75x55 mm Dist. mount. holes: 56 mm
			Socket type: BA15S Shape: Rectangular Bracket: Straight Rear/fog lamp: w/ E-approval: Yes
170928 Rear Fog Lamp		Watt: 21	Dim.: 102x95x55 mm Dist. mount. holes: 77 mm
			Socket type: BA15S Colour: Black Material: Shockproof plastic Shape: Rectangular Fixing screw: 2 E-approval: Yes
170929 Rear Fog Lamp		Bulb incl.: No Watt: 21	Dim.: 140x90 mm Dist. mount. holes: 45 mm
			Socket type: BA15S Colour: Black Material: Shockproof plastic Fixing screw: 2 Rear/fog lamp: w/ Wiring system: w/ E-approval: Yes
170930 Rear Fog Lamp		Watt: 21	Dim.: 125x84x68 mm
			Socket type: BA15S Colour: Black Material: Shockproof plastic Bracket: Pendant Fixing screw: 1 Rear/fog lamp: w/ E-approval: Yes
171219 Rear Fog Lamp		Watt: 21	Dim.: 93x99x50 mm Dist. mount. holes: 45 mm
			Socket type: BA15S Colour: Black Material: Shockproof plastic Shape: Hexagon Fixing screw: 2 Rear/fog lamp: w/ E-approval: Yes

ACCESSORIES - Lighting

O.E.M. names and numbers are used for reference purposes only.

171220 Rear Fog Lamp

w/ Grommet.

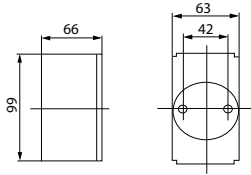

Watt: 21

Dim.: 63x99x66 mm
Dist. mount. holes:
42 mm

Socket type: BA15S
Material: Shockproof plastic
Shape: Rectangular
Sidemarker: w/
E-approval: Yes

REAR FOG LAMPS LED

170909 LED Fog/Reverse Lamp

Lens and o-ring: HC-CARGO 170910.

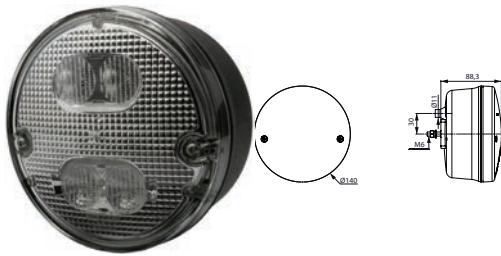

Voltage: 12/24

Dim.: 140x88.3 mm
Dist. mount. holes:
45 mm

Type: LED
Colour/glass: White
Material: Shockproof plastic
Shape: Round
Fixing screw: 2
Rear/fog lamp: w/
Tail light: w/
LEDs: w/
No./LEDs: 4
E-approval: Yes

171685 LED Rear Fog Lamp

Can be flush mounted by using HC-CARGO 171266.

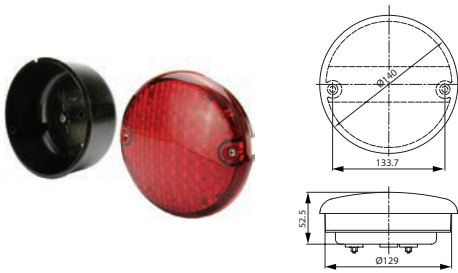

Voltage: 9-33

Dim.: 140x52.5 mm
Dist. mount. holes:
45 mm

Type: Rear fog lamp
Colour: Red
Material: Shockproof plastic
Shape: Circular
Rear/fog lamp: w/
No./LEDs: 61

171726 LED Fog/Reverse Lamp

Ring: clear, center: red.



Voltage: 12/24

Dim.: 122x84.5 mm
Cable length: 150 mm
Dist. mount. holes:
44 mm

Type: LED
Material: Shockproof plastic
Material/dome: Shockproof plastic
Rear/fog lamp: w/
Reverse light: w/
No./LEDs: 38
E-approval: Yes

SPARE PARTS

170910 Lens, Rear Lamp

Servicing: HC-CARGO 170909

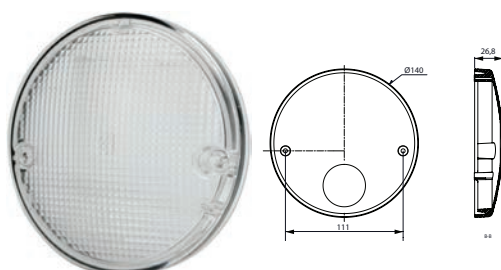

OD: 140 mm
Dim.: 140x26.8 mm
Dist. mount. holes:
111 mm

Colour: White
Shape: Round

MULTI FUNCTION LAMPS
TRAILER LAMPS CONVENTIONAL
170685 Multi Function Lamp

Lens: HC-CARGO 170687.

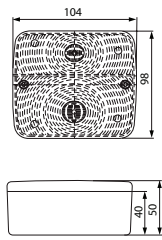

 Bulb incl.: No
 Watt: 21
 Watt 2: 21/5

 Dim.: 104x98x50 mm
 Dist. mount. holes:
 45/55 mm

 Socket type: BA15S
 Socket type 2: BAY15d
 Material: Shockproof plastic
 Fixing screw: 2
 Flasher light: w/
 Tail light: w/
 Stop light: w/
 RH/LH: RH/LH
 E-approval: Yes

170846 Multi Function Lamp

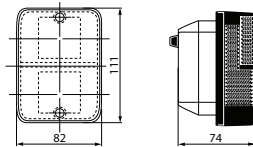
Lens: HC-CARGO 170847.

 Bulb incl.: No
 Watt: 10
 Watt 2: 21/5

 Dim.: 111x82x74 mm
 Dist. mount. holes:
 57/87 mm

 Socket type: BA15S
 Socket type 2: BAY15d
 Material: Shockproof plastic
 Fixing screw: 4
 Flasher light: w/
 Tail light: w/
 Stop light: w/
 RH/LH: RH/LH
 E-approval: Yes

170939 Multi Function Lamp

Servicing: HC-CARGO 170809, 170818, 170828, 170829, 170835, 171049

Lens: HC-CARGO 170833.

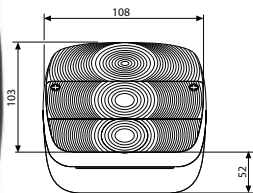
 Bulb incl.: No
 Watt: 21
 Watt 2: 21/5

 Dim.: 108x103x52 mm
 Dist. mount. holes:
 45/55 mm

 Socket type: BA15S
 Socket type 2: BAY15d
 Material: Shockproof plastic
 Fixing screw: 2
 Flasher light: w/
 Tail light: w/
 Stop light: w/
 RH/LH: RH/LH
 E-approval: Yes

170940 Multi Function Lamp

Servicing: HC-CARGO 170829

Lens: HC-CARGO 170833.

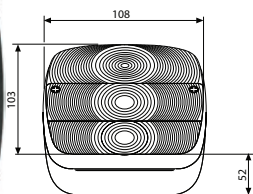

 Bulb incl.: No
 Watt: 21
 Watt 2: 21/5

 Dim.: 108x103x52 mm
 Dist. mount. holes:
 45/55 mm

 Socket type: BA15S
 Socket type 2: BAY15d
 Material: Shockproof plastic
 Fixing screw: 2
 Flasher light: w/
 Numberplate light: w/
 Tail light: w/
 Stop light: w/
 RH/LH: RH/LH
 E-approval: Yes

170943 Multi Function Lamp

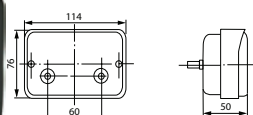
Lens: HC-CARGO 170944.



 Bulb incl.: No
 Watt: 21
 Watt 2: 21/5

 Dim.: 114x76x50 mm
 Dist. mount. holes:
 60 mm

 Socket type: BA15S
 Socket type 2: BAY15d
 Material: Shockproof plastic
 Shape: Rectangular
 Fixing screw: 2
 Flasher light: w/
 Tail light: w/
 Stop light: w/
 RH/LH: RH/LH
 E-approval: Yes

170985 Multi Function Lamp

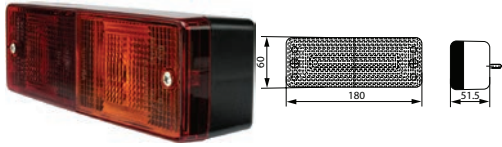
Lens: HC-CARGO 170987.



 Bulb incl.: No
 Watt: 10
 Watt 2: 21/5

 Dim.: 180x60x51.5 mm
 Dist. mount. holes:
 134 mm

 Socket type: BA15S
 Socket type 2: BAY15d
 Material: Shockproof plastic
 Shape: Rectangular
 Fixing screw: 2
 Flasher light: w/
 Tail light: w/
 Stop light: w/
 RH/LH: RH/LH
 E-approval: Yes

170986 Multi Function Lamp

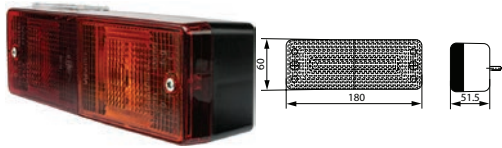
Lens: HC-CARGO 170987.



 Bulb incl.: No
 Watt: 10
 Watt 2: 21/5

 Dim.: 180x60x51.5 mm
 Dist. mount. holes:
 134 mm

 Socket type: BA15S
 Socket type 2: BAY15d
 Material: Shockproof plastic
 Shape: Rectangular
 Fixing screw: 2
 Flasher light: w/
 Numberplate light: w/
 Tail light: w/
 Stop light: w/
 RH/LH: RH/LH
 E-approval: Yes

171013 Multi Function Lamp

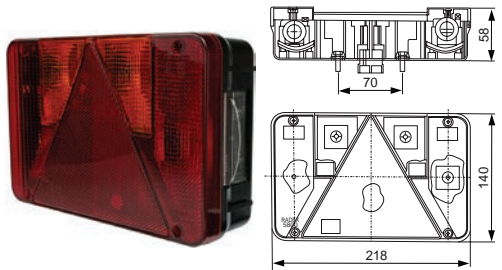
Lens: HC-CARGO 171015. Right: HC-CARGO 171014.



 Bulb incl.: No
 Watt: 21
 Watt 2: 21/5

 Dim.: 218x140x58 mm
 Dist. mount. holes:
 70 mm

 Socket type: BA15S
 Socket type 2: BAY15d
 Material: Shockproof plastic
 Shape: Rectangular
 Reflector: w/
 Fixing screw: 2
 Flasher light: w/
 Numberplate light: w/
 Tail light: w/
 Stop light: w/
 RH/LH: LH
 E-approval: Yes

171014 Multi Function Lamp

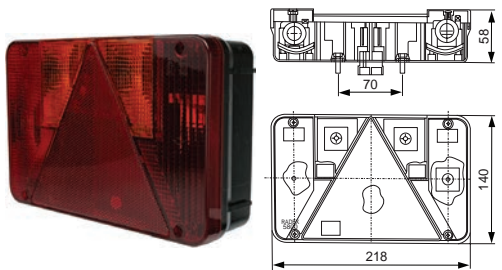
Lens: HC-CARGO 171016. Left: HC-CARGO 171013.



 Bulb incl.: No
 Watt: 21
 Watt 2: 21/5

 Dim.: 218x140x58 mm
 Dist. mount. holes:
 70 mm

 Socket type: BA15S
 Socket type 2: BAY15d
 Material: Shockproof plastic
 Shape: Rectangular
 Reflector: w/
 Fixing screw: 2
 Flasher light: w/
 Numberplate light: w/
 Tail light: w/
 Stop light: w/
 RH/LH: RH

171050 Multi Function Lamp

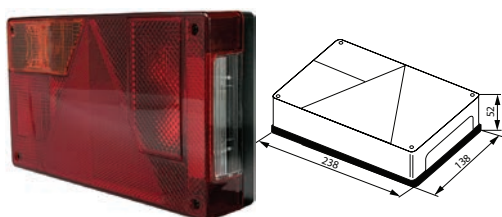
Lens: HC-CARGO 171057. Plug: HC-CARGO 171372, 171373. Right: HC-CARGO 171053.



 Bulb incl.: No
 Watt: 21
 Watt 2: 21/5
 Watt 3: 5

 Dim.: 238x138x52 mm
 Dist. mount. holes:
 152 mm

 Socket type: BA15S
 Socket type 2: BAY15d
 Socket type 3: S8.5
 Material: Shockproof plastic
 Shape: Rectangular
 Reflector: w/
 Fixing screw: 2
 Flasher light: w/
 Numberplate light: w/
 Rear/fog lamp: w/
 Tail light: w/
 Stop light: w/
 RH/LH: LH
 E-approval: Yes

171051 Multi Function Lamp

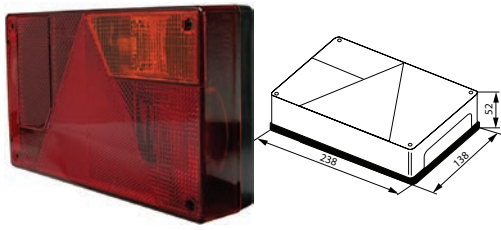
Lens: HC-CARGO 171056. Plug: HC-CARGO 171372, 171373. Left: HC-CARGO 171054.



Bulb incl.: No
Watt: 21
Watt 2: 21/5
Watt 3: 5

Dim.: 238x138x52 mm
Dist. mount. holes:
152 mm

Socket type: BA15S
Socket type 2: BAY15d
Socket type 3: S8.5
Material: Shockproof plastic
Shape: Rectangular
Reflector: w/
Fixing screw: 2
Flasher light: w/
Numberplate light: w/
Tail light: w/
Stop light: w/
RH/LH: RH
E-approval: Yes

171052 Multi Function Lamp

Lens: HC-CARGO 171058. Supplied w/ HC-CARGO 171372, 171373. Left: HC-CARGO 171055.

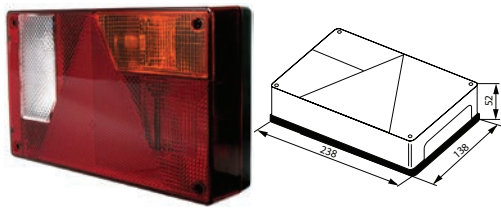

Bulb incl.: No
Watt: 21
Watt 2: 21/5
Watt 3: 5

Dim.: 238x138x52 mm
Dist. mount. holes:
152 mm

Socket type: BA15S
Socket type 2: BAY15d
Socket type 3: S8.5
Material: Shockproof plastic
Shape: Rectangular
Reflector: w/
Fixing screw: 2
Flasher light: w/
Numberplate light: w/
Reverse light: w/
Tail light: w/
Stop light: w/
RH/LH: RH
E-approval: Yes

171053 Multi Function Lamp

Lens: HC-CARGO 171056. Left: HC-CARGO 171050.

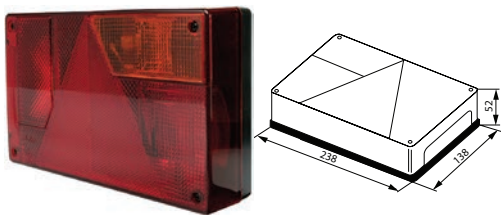

Bulb incl.: No
Watt: 21
Watt 2: 21/5
Watt 3: 5

Dim.: 238x138x52 mm
Dist. mount. holes:
152 mm

Socket type: BA15S
Socket type 2: BAY15d
Socket type 3: S8.5
Material: Shockproof plastic
Shape: Rectangular
Reflector: w/
Fixing screw: 2
Flasher light: w/
Numberplate light: w/
Rear/fog lamp: w/
Tail light: w/
Stop light: w/
RH/LH: RH
E-approval: Yes

171054 Multi Function Lamp

Lens: HC-CARGO 171057. Plug: HC-CARGO 171372, 171373. Right: HC-CARGO 171051.

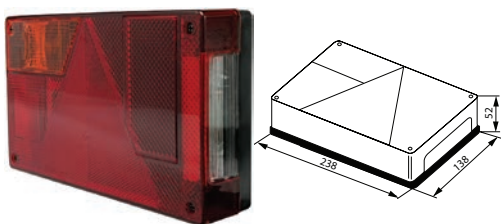

Bulb incl.: No
Watt: 21
Watt 2: 21/5
Watt 3: 5

Dim.: 238x138x52 mm
Dist. mount. holes:
152 mm

Socket type: BA15S
Socket type 2: BAY15d
Socket type 3: S8.5
Material: Shockproof plastic
Shape: Rectangular
Reflector: w/
Fixing screw: 2
Flasher light: w/
Numberplate light: w/
Tail light: w/
Stop light: w/
RH/LH: LH
E-approval: Yes

171055 Multi Function Lamp

Lens: HC-CARGO 171059. Plug: HC-CARGO 171372, 171373. Right: HC-CARGO 171052.

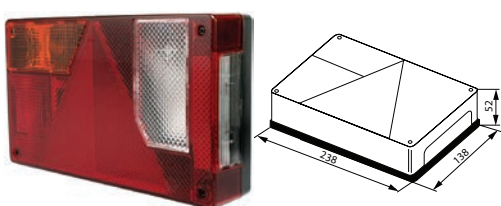

Bulb incl.: No
Watt: 21
Watt 2: 21/5
Watt 3: 5

Dim.: 238x138x52 mm
Dist. mount. holes:
152 mm

Socket type: BA15S
Socket type 2: BAY15d
Socket type 3: S8.5
Material: Shockproof plastic
Shape: Rectangular
Reflector: w/
Fixing screw: 2
Flasher light: w/
Numberplate light: w/
Reverse light: w/
Tail light: w/
Stop light: w/
RH/LH: LH
E-approval: Yes

171191 Multi Function Lamp

Lens: HC-CARGO 171236.

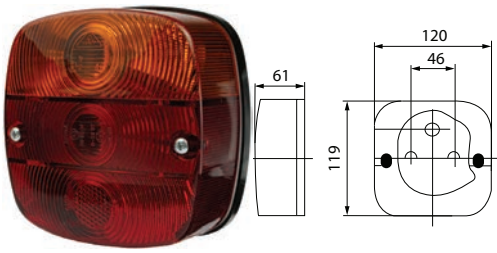

Bulb incl.: No
Watt: 21
Watt 2: 10

Dim.: 120x119x61 mm
Dist. mount. holes:
46 mm

Socket type: BA15S
Socket type 2: BA15S
Material: Shockproof plastic
Fixing screw: 2
Flasher light: w/
Numberplate light: w/
Tail light: w/
Stop light: w/
RH/LH: RH/LH
E-approval: Yes

171192 Multi Function Lamp

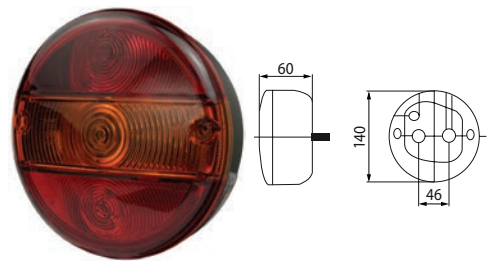

Bulb incl.: No

Dim.: 140x60 mm
Dist. mount. holes:
46 mm

Material: Shockproof plastic
Shape: Round
Fixing screw: 2
Flasher light: w/
Numberplate light: w/
Tail light: w/
Stop light: w/
E-approval: Yes

171193 Multi Function Lamp

Mounting kit: HC-CARGO 171266.

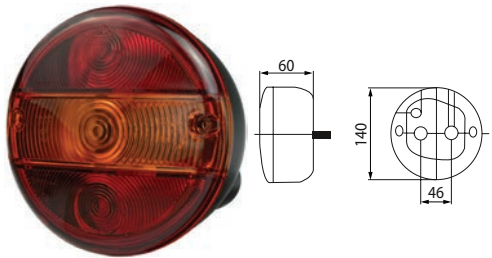

Bulb incl.: No

Dim.: 140x60 mm
Dist. mount. holes:
45 mm

Material: Shockproof plastic
Shape: Round
Fixing screw: 2
Flasher light: w/
Tail light: w/
Stop light: w/
E-approval: Yes

171194 Multi Function Lamp

Lens: HC-CARGO 171237.

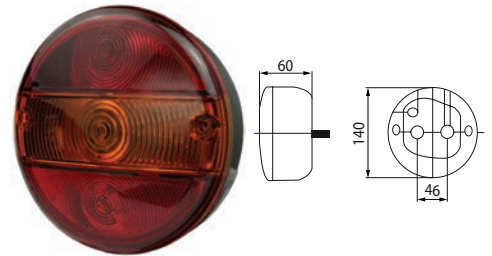

Bulb incl.: No
Watt: 21
Watt 2: 5

Dim.: 140x60 mm
Dist. mount. holes:
45 mm

Socket type: BA15S
Socket type 2: BA15S
Material: Shockproof plastic
Shape: Round
Fixing screw: 2
Flasher light: w/
Numberplate light: w/
Tail light: w/
Stop light: w/

171195 Multi Function Lamp

Mounting kit: HC-CARGO 171266.

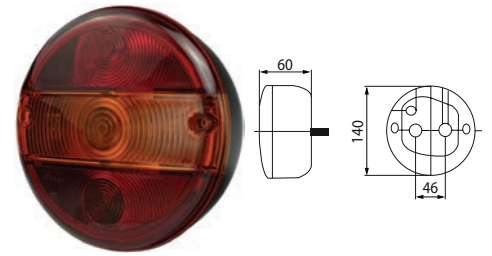

Bulb incl.: No

Dim.: 140x60 mm
Dist. mount. holes:
45 mm

Material: Shockproof plastic
Shape: Round
Fixing screw: 2

171202 Multi Function Lamp

Lens: HC-CARGO 171253.

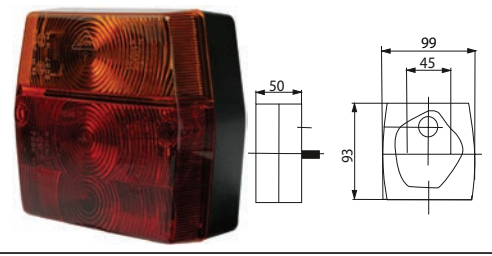

Bulb incl.: No
Watt: 21
Watt 2: 5

Dim.: 93x99x50 mm
Dist. mount. holes:
45 mm

Socket type: BA15S
Socket type 2: S8.5
Material: Shockproof plastic
Shape: Hexagon
Fixing screw: 2
Flasher light: w/
Tail light: w/
Stop light: w/
E-approval: Yes

171203 Multi Function Lamp

Lens: HC-CARGO 171258. Right: HC-CARGO 171204.

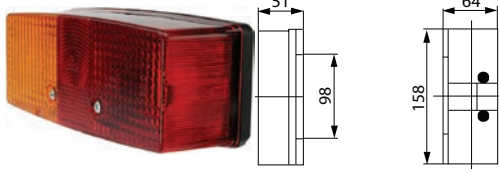

Bulb incl.: No
Watt: 21
Watt 2: 10

Dim.: 158x64x51 mm
Dist. mount. holes:
98/45 mm

Socket type: BA15S
Socket type 2: BA15S
Material: Shockproof plastic
Shape: Rectangular
Reflector: w/
Fixing screw: 4
Flasher light: w/
Numberplate light: w/
Tail light: w/
Stop light: w/
RH/LH: LH
E-approval: Yes

171204 Multi Function Lamp

Lens: HC-CARGO 171259. Left: HC-CARGO 171203.

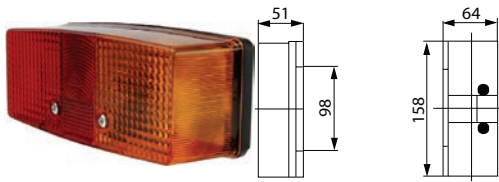

Bulb incl.: No
Watt: 10
Watt 2: 21

Dim.: 158x64x51 mm
Dist. mount. holes:
98/45 mm

Socket type: BA15S
Socket type 2: BA15S
Material/dome: Shockproof plastic
Shape: Rectangular
Reflector: w/
Fixing screw: 4
Flasher light: w/
Numberplate light: w/
Tail light: w/
Stop light: w/
RH/LH: RH

171213 Multi Function Lamp

Lens: HC-CARGO 171264. Right: HC-CARGO 171214.

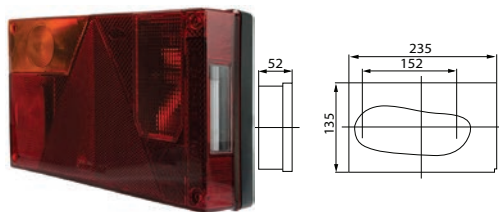

Bulb incl.: No
Watt: 21
Watt 2: 21/5
Watt 3: 5

Dim.: 235x135x52 mm
Dist. mount. holes:
152 mm

Socket type: BA15S
Socket type 2: BAY15d
Socket type 3: S8.5
Material: Shockproof plastic
Shape: Rectangular
Reflector: w/
Fixing screw: 2
Flasher light: w/
Numberplate light: w/
Tail light: w/
Stop light: w/
RH/LH: LH
E-approval: Yes

171214 Multi Function Lamp

Lens: HC-CARGO 171265. Left: HC-CARGO 171213.

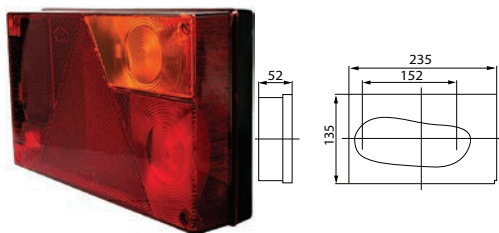

Bulb incl.: No
Watt: 21
Watt 2: 21/5
Watt 3: 5

Dim.: 235x135x52 mm
Dist. mount. holes:
152 mm

Socket type: BA15S
Socket type 2: BAY15d
Socket type 3: S8.5
Material: Shockproof plastic
Shape: Rectangular
Reflector: w/
Fixing screw: 2
Flasher light: w/
Numberplate light: w/
Tail light: w/
Stop light: w/
RH/LH: RH
E-approval: Yes

171328 Multi Function Lamp

Lens: HC-CARGO 171330.

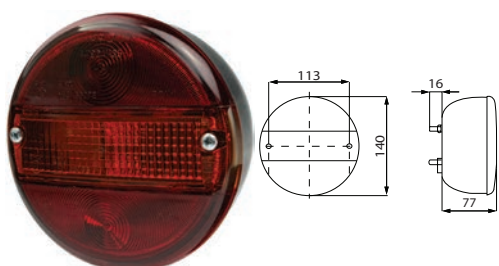

Bulb incl.: No
Watt: 21
Watt 2: 5

Dim.: 140x77 mm
OD: 140 mm
Dist. mount. holes:
45 mm

Socket type: BA15S
Socket type 2: BA15S
Material: Shockproof plastic
Shape: Circular
Fixing screw: 2
Flasher light: w/
Numberplate light: w/
Tail light: w/
Stop light: w/
E-approval: Yes

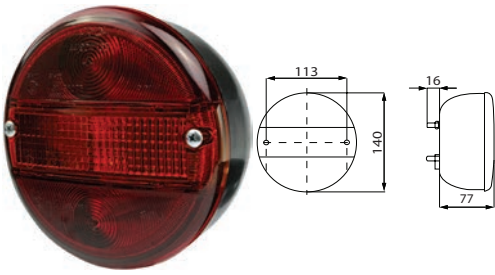
171329 Multi Function Lamp
Mounting kit: HC-CARGO 171266. Lens: HC-CARGO 171330.

Bulb incl.: No

Dim.: 140x77 mm
Dist. mount. holes: 45 mm

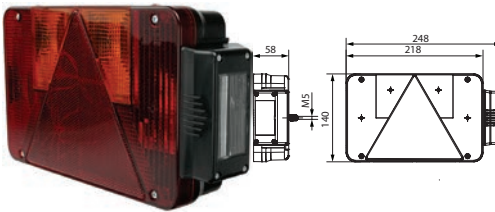
Socket type: BA15S
Material: Shockproof plastic
Shape: Circular
Fixing screw: 2
Flasher light: w/
Tail light: w/
Stop light: w/
E-approval: Yes

171533 Multi Function Lamp
Lens: HC-CARGO 171015. Plug: HC-CARGO 171537, 171538. Right: HC-CARGO 171534.

Bulb incl.: No
Watt: 21
Watt 2: 21/5
Watt 3: 5

Dim.: 248x140x58 mm
Dist. mount. holes: 70 mm

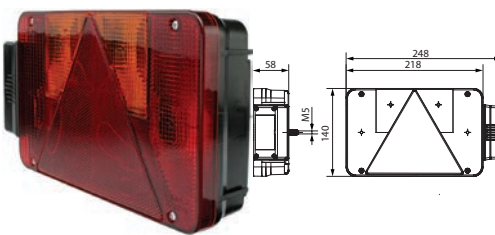
Socket type: BA15S
Socket type 2: BAY15d
Socket type 3: S8.5
Material: Shockproof plastic
Shape: Rectangular
Reflector: w/
Fixing screw: 2
Flasher light: w/
Numberplate light: w/
Tail light: w/
Stop light: w/
RH/LH: LH

171534 Multi Function Lamp
Lens: HC-CARGO 171016. Plug: HC-CARGO 171537, 171538. Left: HC-CARGO 171533.

Bulb incl.: No
Watt: 21
Watt 2: 21/5
Watt 3: 5

Dim.: 248x140x58 mm
Dist. mount. holes: 70 mm

Socket type: BA15S
Socket type 2: BAY15d
Socket type 3: S8.5
Material: Shockproof plastic
Shape: Rectangular
Reflector: w/
Fixing screw: 2
Flasher light: w/
Numberplate light: w/
Tail light: w/
Stop light: w/
RH/LH: RH

171822 Multi Function Lamp

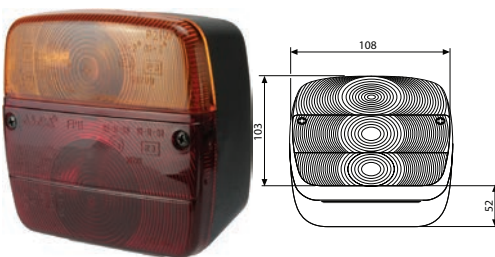
Servicing: HC-CARGO 171821

Multi connector: HC-CARGO 171372, 171373. Lens: HC-CARGO 170833.

Bulb incl.: Yes
Watt: 21
Watt 2: 21/5



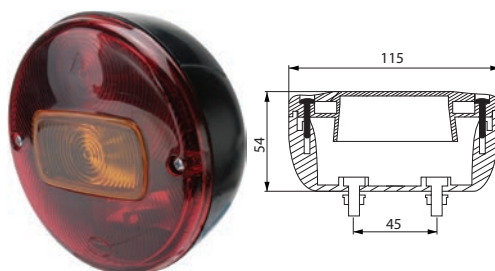



Dim.: 108x103x52 mm
Dist. mount. holes: 45/55 mm

Socket type: BA15S
Socket type 2: BAY15d
Shape: Square
Flasher light: w/
Sidemarkers: w/
Stop light: w/
E-approval: Yes

171917 Multi Function Lamp

Bulb incl.: No
Watt: 5
Watt 2: 18
Watt 3: 18

Dim.: 115x54 mm
Dist. mount. holes: 45 mm

Bulb type: 10.5x36 mm
Bulb type 2: 15x41 mm
Bulb type 3: 15x41 mm
Socket type: S8.5
Socket type 2: S8.5
Socket type 3: S8.5
Colour/glass: Red/yellow
Material/dome: PMMA
Shape: Round
Fixing screw: 2
Flasher light: w/
Tail light: w/
Stop light: w/
RH/LH: RH/LH

SPARE PARTS			
170687 Lens, Rear Lamp		Servicing: HC-CARGO 170685	
		Dim.: 104x98 mm	RH/LH: RH/LH
170833 Lens, Rear Lamp		Servicing: HC-CARGO 170939, 170940	
		Dim.: 108x103x52 mm	Material: Shockproof plastic Flasher light: w/ Tail light: w/ Stop light: w/ RH/LH: RH/LH
170847 Lens, Rear Lamp		Servicing: HC-CARGO 170846	
		Dim.: 111x82 mm	Material: Shockproof plastic RH/LH: RH/LH
170944 Lens, Rear Lamp		Servicing: HC-CARGO 170943	
		Dim.: 120x80 mm	Material: Shockproof plastic Shape: Rectangular RH/LH: RH/LH
170987 Lens, Rear Lamp		Servicing: HC-CARGO 170985, 170986	
		Dim.: 180x60 mm	Material: Shockproof plastic Shape: Rectangular RH/LH: RH/LH
171015 Lens, Rear Lamp		Servicing: HC-CARGO 171013, 171533	
		Dim.: 218x140 mm	Material: Shockproof plastic Shape: Rectangular Reflector: w/ RH/LH: LH
171016 Lens, Rear Lamp		Servicing: HC-CARGO 171534, 171014	
		Dim.: 218x140 mm	Material: Shockproof plastic Shape: Rectangular Reflector: w/ RH/LH: RH

ACCESSORIES - Lighting

O.E.M. names and numbers are used for reference purposes only.

EL. SPECIFICATIONS	DIMENSIONS	ADDITIONAL SPECIFICATIONS
171056 Lens, Rear Lamp 	Servicing: HC-CARGO 171051, 171053 Dim.: 235x135x52 mm	Material: Shockproof plastic Shape: Rectangular Reflector: w/ Numberplate light: w/ RH/LH: RH
171057 Lens, Rear Lamp 	Servicing: HC-CARGO 171050, 171054 Dim.: 235x135x52 mm	Material: Shockproof plastic Shape: Rectangular Reflector: w/ Numberplate light: w/ RH/LH: LH
171058 Lens, Rear Lamp 	Servicing: HC-CARGO 171052 Dim.: 235x135 mm	Material: Shockproof plastic Shape: Rectangular Reflector: w/ Numberplate light: w/ RH/LH: RH
171059 Lens, Rear Lamp 	Servicing: HC-CARGO 171055 Dim.: 235x135 mm	Material: Shockproof plastic Shape: Rectangular Reflector: w/ Numberplate light: w/ RH/LH: LH
171162 Lens, Rear Lamp 	Servicing: Ford Transit 1986 - Visit www.hc-cargo.com for further information Dim.: 364x94 mm	Material: Shockproof plastic Shape: Rectangular Reflector: w/ E-approval: Yes
171236 Lens, Rear Lamp 	Servicing: HC-CARGO 171191 Dim.: 122.5x122.5x53 mm	Shape: Square RH/LH: RH/LH
171237 Lens, Rear Lamp 	Servicing: HC-CARGO 171192, 171193, 171194, 171195 OD: 140 mm	Type: Tail lamp Material: Plastic Shape: Circular RH/LH: RH/LH

EL. SPECIFICATIONS	DIMENSIONS	ADDITIONAL SPECIFICATIONS
171253 Lens, Rear Lamp 	Servicing: HC-CARGO 171202 Dim.: 93x99 mm	Material: Shockproof plastic Shape: Hexagon RH/LH: RH/LH
171258 Lens, Rear Lamp 	Servicing: HC-CARGO 171203 Dim.: 158x64 mm	Material: Shockproof plastic Shape: Rectangular Reflector: w/ RH/LH: LH
171259 Lens, Rear Lamp 	Servicing: HC-CARGO 171204 Dim.: 158x64 mm	Shape: Rectangular Reflector: w/ RH/LH: RH
171264 Lens, Rear Lamp 	Servicing: HC-CARGO 171213 Dim.: 235x135 mm	Shape: Rectangular Reflector: w/ Numberplate light: w/ RH/LH: LH
171265 Lens, Rear Lamp 	Servicing: HC-CARGO 171214 Dim.: 235x135 mm	Shape: Rectangular Reflector: w/ Numberplate light: w/ RH/LH: RH
171330 Lens, Rear Lamp 	Servicing: HC-CARGO 171328, 171329 OD: 140 mm	Shape: Circular RH/LH: RH/LH

ACCESSORIES

170604 Vibration Damper

Servicing: HC-CARGO 170602, 171323

Gives a longer life to the bulbs.

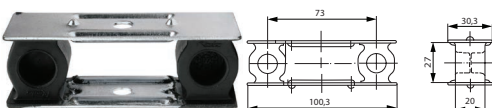

171266 Repair Kit

Servicing: HC-CARGO 171193, 171195, 171329, 171549, 171550

Circulars.



171372 Multi Connector

Servicing: HC-CARGO 171050, 171051, 171052, 171053, 171054, 171055, 171818, 171821

Socket w/ quick connection.

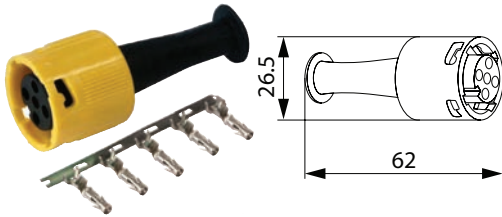

Dim.: 62x26.5 mm

Colour/glass: Yellow
RH/LH: LH
E-approval: Yes

171373 Multi Connector

Servicing: HC-CARGO 171050, 171051, 171052, 171053, 171054, 171055, 171818, 171821

Socket w/ quick connection.

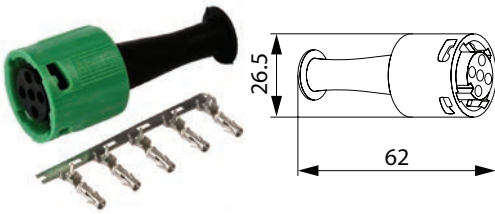

Dim.: 62x26.5 mm

Colour/glass: Green
RH/LH: RH
E-approval: Yes

171537 Multi Connector

Servicing: HC-CARGO 171533, 171534

Socket w/ quick connection.



Colour: Red
RH/LH: LH

171538 Multi Connector

Servicing: HC-CARGO 171533, 171534

Socket w/ quick connection.



Colour: Green
RH/LH: RH

171788 Multiconnector 7 pin

Servicing: HC-CARGO 171756, 171757

Gasket: HC-CARGO 192178.

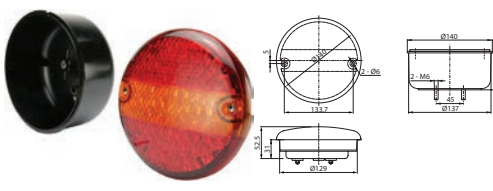
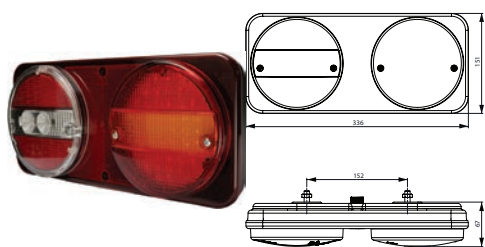
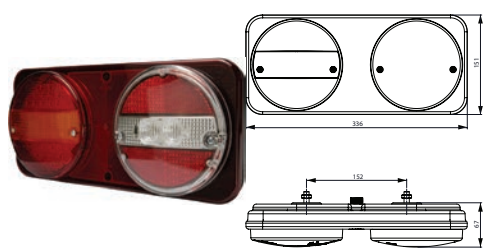
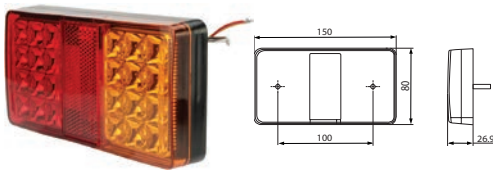
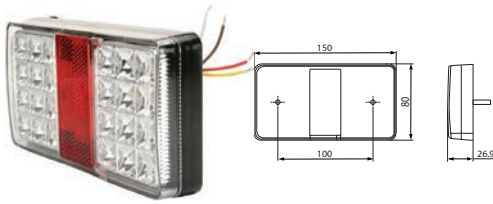

Type/terminal: Round
Colour: Black
No./poles: 7
Plug: Female

	EL. SPECIFICATIONS	DIMENSIONS	ADDITIONAL SPECIFICATIONS
181627 Bayonet connector 	Servicing: HC-CARGO 181617 Voltage: 12		Mount.: Terminal No./poles: 8
TRAILER LAMPS LED			
171549 LED Multifunction Lamp Mounting kit: HC-CARGO 171266. 	Voltage: 9-33	Dim.: 140x85 mm Dist. mount. holes: 45 mm	Type: LED Colour: Black Material: Shockproof plastic Shape: Circular Fixing screw: 2 Flasher light: w/ Tail light: w/ Stop light: w/ No./LEDs: 63 E-approval: Yes
171665 LED Multifunction Lamp Right: HC-CARGO 171666. 	Voltage: 12/24	Dim.: 336x151x67 mm Dist. mount. holes: 152 mm	Type: LED Material: Shockproof plastic Shape: Rectangular Reflector: w/ Flasher light: w/ Reverse light: w/ Tail light: w/ Stop light: w/ RH/LH: LH E-approval: Yes
171666 LED Multifunction Lamp Left: HC-CARGO 171665. 	Voltage: 12/24	Dim.: 336x151x67 mm Dist. mount. holes: 152 mm	Type: LED Material: Shockproof plastic Shape: Rectangular Reflector: w/ Flasher light: w/ Reverse light: w/ Tail light: w/ Stop light: w/ RH/LH: RH E-approval: Yes
171667 LED Multifunction Lamp White = ground. Brown = tail light. Red = stop. Yellow = indicator. 	Voltage: 12/24	Dim.: 150x80x26.9 mm Dist. mount. holes: 100 mm	Type: LED Material: Plastic Shape: Rectangular Reflector: w/ Flasher light: w/ Tail light: w/ Stop light: w/ No./LEDs: 24 Tightness norm: IP 67 E-approval: Yes
171668 LED Multifunction Lamp White = ground. Brown = tail light. Red = stop. Yellow = indicator. 	Voltage: 12/24	Dim.: 150x80x26.9 mm Dist. mount. holes: 100 mm	Type: LED Colour/glass: Transparent Material: Shockproof plastic Material/dome: Glass Shape: Rectangular Reflector: w/ Flasher light: w/ Tail light: w/ Stop light: w/ No./LEDs: 24 Tightness norm: IP 67 E-approval: Yes

171725 LED Tail-Position Lamp
Ring: amber, center: red.

Voltage: 12/24

Dim.: 122x84.5 mm
Cable length: 150 mm
Dist. mount. holes: 44 mm

Type: LED
Material: Shockproof plastic
Material/dome: Shockproof plastic
Shape: Round
Fixing screw: 6
Flasher light: w/
Tail light: w/
Stop light: w/
No./LEDs: 44
E-approval: Yes

171726 LED Fog/Reverse Lamp
Ring: clear, center: red.

Voltage: 12/24

Dim.: 122x84.5 mm
Cable length: 150 mm
Dist. mount. holes: 44 mm

Type: LED
Material: Shockproof plastic
Material/dome: Shockproof plastic
Rear/fog lamp: w/
Reverse light: w/
No./LEDs: 38
E-approval: Yes

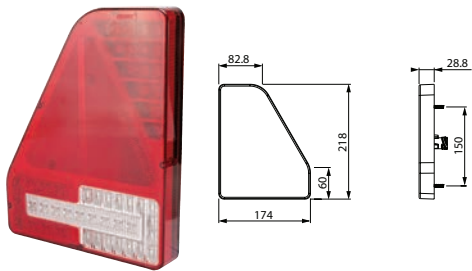
171756 LED Multifunction Lamp
Multi-plug: HC-CARGO 171788.

Voltage: 12/24

Dim.: 174x218x28.8 mm
Dist. mount. holes: 150 mm

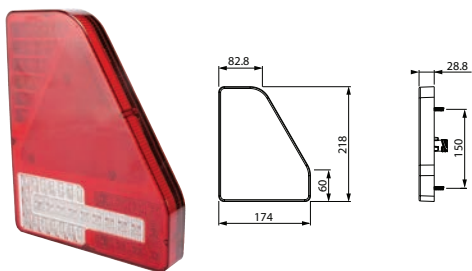
Type: Tail/position lamp
Material: Shockproof plastic
Material/dome: Shockproof plastic
Shape: Triangle
Reflector: w/
Flasher light: w/
Rear/fog lamp: w/
Reverse light: w/
Tail light: w/
Stop light: w/
RH/LH: RH
Tightness norm: IP 67
Approvals: CE
E-approval: Yes

171757 LED Multifunction Lamp
Multi-plug: HC-CARGO 171788.

Voltage: 12/24

Dim.: 174x218x28.8 mm
Dist. mount. holes: 150 mm

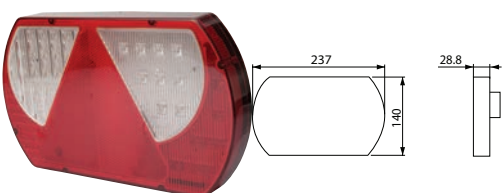
Type: Tail/position lamp
Material: Shockproof plastic
Material/dome: Shockproof plastic
Shape: Triangle
Reflector: w/
Flasher light: w/
Rear/fog lamp: w/
Reverse light: w/
Tail light: w/
Stop light: w/
RH/LH: LH
Tightness norm: IP 67
Approvals: CE
E-approval: Yes

171758 LED Multifunction Lamp
White = ground. Red = stop. Black = tail. Yellow = indicator. Brown = reverse.

Voltage: 12/24

Dim.: 237x140x28.8 mm
Cable length: 2000 mm
Dist. mount. holes: 152 mm

Type: Tail lamp
Material: Shockproof plastic
Material/dome: Shockproof plastic
Shape: Oval
Mount.: 2 screws
Reflector: w/
Flasher light: w/
Numberplate light: w/
Reverse light: w/
Tail light: w/
Stop light: w/
RH/LH: RH
Tightness norm: IP 66
E-approval: Yes

171759 LED Multifunction Lamp

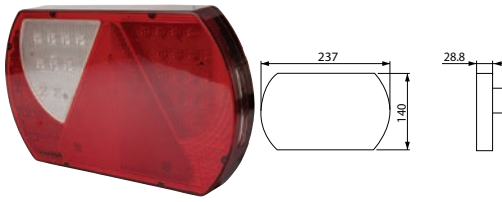
White = ground. Red = stop. Black = tail. Yellow = indicator. Blue = fog.



Voltage: 12/24

Dim.: 237x140x28.8 mm
Cable length: 2000 mm
Dist. mount. holes: 152 mm

Type: Tail lamp
Material: Shockproof plastic
Material/dome: Shockproof plastic
Shape: Oval
Mount.: 2 screws
Reflector: w/
Flasher light: w/
Numberplate light: w/
Rear/fog lamp: w/
Tail light: w/
Stop light: w/
RH/LH: LH
Tightness norm: IP 66
E-approval: Yes

171772 LED Multifunction Lamp

White=ground. Brown=tail. Yellow=flasher. Red=stop.

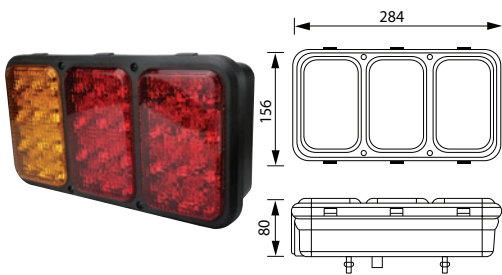

Voltage: 24

Dim.: 284x156x80 mm
Dist. mount. holes: 136x85 mm

Type: Tail lamp
Material: Polypropylene
Material/dome: PMMA
Shape: Rectangular
Mount.: 4 screws
Reflector: w/
Flasher light: w/
Tail light: w/
Stop light: w/
No./LEDs: 3x16
RH/LH: RH/LH
E-approval: Yes

171789 LED Multifunction Lamp

Vertical mount.

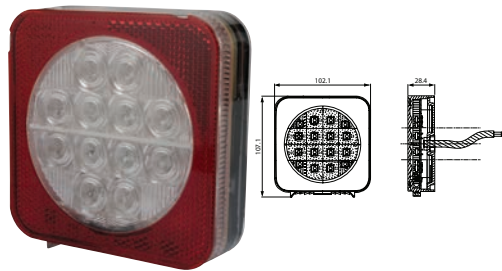

Voltage: 12/24

Dim.: 102.1x107.1x28.4 mm
Cable length: 500 mm
Dist. mount. holes: 45 mm

Type: Tail lamp
Bulb type: LED
Material: Polycarbonate
Material/dome: Polycarbonate
Shape: Square
Mount.: 2 screws
Reflector: w/
Flasher light: w/
Numberplate light: w/
Tail light: w/
Stop light: w/
No./LEDs: 12
RH/LH: RH/LH
Tightness norm: IP 67
E-approval: Yes

171790 LED Multifunction Lamp

Vertical mount.



Voltage: 12/24

Dim.: 102.1x107.1x28.4 mm
Cable length: 500 mm
Dist. mount. holes: 45 mm

Type: Tail lamp
Material: Polycarbonate
Material/dome: Polycarbonate
Shape: Square
Mount.: 2 screws
Reflector: w/
Flasher light: w/
Tail light: w/
Stop light: w/
No./LEDs: 12
RH/LH: RH/LH
Tightness norm: IP 67
E-approval: Yes

171791 LED Multifunction Lamp

Horizontal mount.

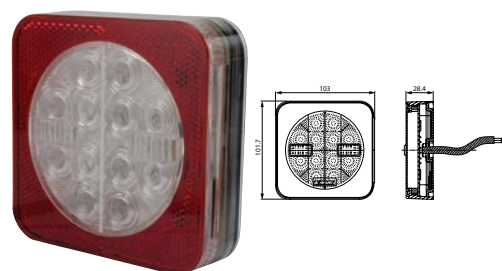

Voltage: 12/24

Dim.: 103x101.7x28.4 mm
Cable length: 500 mm
Dist. mount. holes: 45 mm

Type: Tail lamp
Material: Polycarbonate
Material/dome: Polycarbonate
Shape: Square
Mount.: 2 screws
Reflector: w/
Flasher light: w/
Numberplate light: w/
Tail light: w/
Stop light: w/
No./LEDs: 12
RH/LH: RH/LH
Tightness norm: IP 67
E-approval: Yes

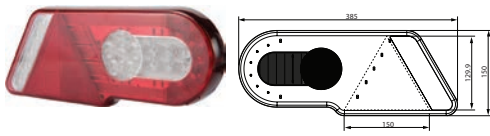
171927 LED Multifunction Lamp
Left: HC-CARGO 171928. Multi-plug: HC-CARGO 171788.

Voltage: 12-24

Dim.: 385x150x34.1 mm
Dist. mount. holes: 152.3 mm

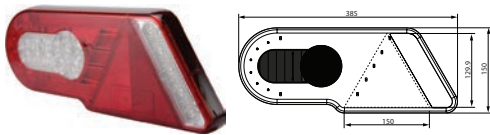
Type: LED
Shape: Rectangular
Reflector: w/
Flasher light: w/
Rear/fog lamp: w/
Reverse light: w/
Tail light: w/
Stop light: w/
RH/LH: RH
Tightness norm: IP 67
Approvals: CE
E-approval: Yes

171928 LED Multifunction Lamp
Right: HC-CARGO 171927. Multi-plug: HC-CARGO 171788.

Voltage: 12-24

Dim.: 385x150x34.1 mm
Dist. mount. holes: 152 mm

Type: LED
Shape: Rectangular
Reflector: w/
Flasher light: w/
Rear/fog lamp: w/
Reverse light: w/
Tail light: w/
Stop light: w/
RH/LH: LH
Tightness norm: IP 67
Approvals: CE
E-approval: Yes

171929 LED Multifunction Lamp
Left: HC-CARGO 171930. Multi-plug: HC-CARGO 171788.

Voltage: 12-24

Dim.: 240.3x140x31 mm
Dist. mount. holes: 152 mm

Type: LED
Shape: Rectangular
Reflector: w/
Flasher light: w/
Rear/fog lamp: w/
Reverse light: w/
Tail light: w/
Stop light: w/
RH/LH: RH
Tightness norm: IP 67
Approvals: CE
E-approval: Yes

171930 LED Multifunction Lamp
Right: HC-CARGO 171929. Multi-plug: HC-CARGO 171788.

Voltage: 12-24

Dim.: 240.3x140x31 mm
Dist. mount. holes: 152 mm

Type: LED
Shape: Rectangular
Reflector: w/
Flasher light: w/
Rear/fog lamp: w/
Reverse light: w/
Tail light: w/
Stop light: w/
RH/LH: LH
Tightness norm: IP 67
Approvals: CE
E-approval: Yes

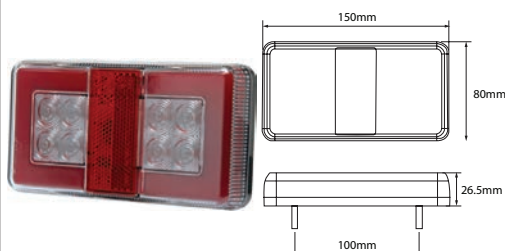
171952 LED Multifunction Lamp

Voltage: 12-24

Dim.: 150x80x26.5 mm
Cable length: 300 mm
Dist. mount. holes: 100 mm

Mount.: 2 screws
Reflector: w/
No./reflectors: 1
Flasher light: w/
Tail light: w/
Stop light: w/
Tightness norm: IP 67
Approvals: CE
E-approval: Yes

ACCESSORIES

160970 Load Resistor 12 V

50 W, 6 Ohm, 2 A.



Length: 50 mm
Width: 15 mm

160971 Load Resistor 24 V

24 V. 50 W. 24 Ohm. 1 A.



Length: 50 mm
Width: 15 mm

TRAILER LAMPS CONVENTIONAL (TRUCKS)

170602 Multi Function Lamp

Servicing: RVI Renault, Pegaso - Visit www.hc-cargo.com for further information

Right: HC-CARGO 170603. Lens: HC-CARGO 170665.

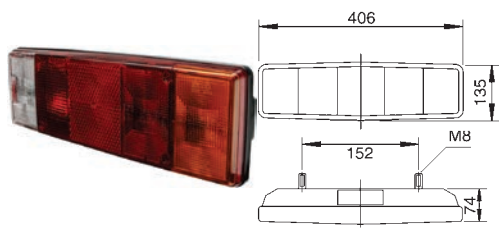

Bulb incl.: No
Watt: 21
Watt 2: 5
Watt 3: 10

Dim.: 406x135x74 mm
Dist. mount. holes:
152 mm

Socket type: BA15S
Socket type 2: BA15S
Socket type 3: BA15S
Material: Shockproof plastic
Shape: Rectangular
Reflector: w/
Flasher light: w/
Numberplate light: w/
Rear/fog lamp: w/
Reverse light: w/
Tail light: w/
Stop light: w/
RH/LH: LH
E-approval: Yes

170603 Multi Function Lamp

Servicing: RVI Renault, Pegaso - Visit www.hc-cargo.com for further information

Left: HC-CARGO 170602. Lens: HC-CARGO 170665.

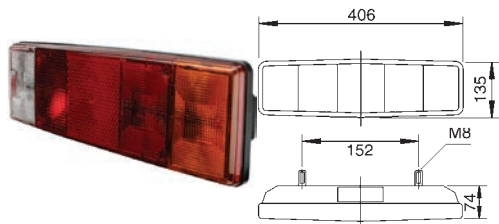

Bulb incl.: No
Watt: 21
Watt 2: 5
Watt 3: 10

Dim.: 406x135x74 mm
Dist. mount. holes:
152 mm

Socket type: BA15S
Socket type 2: BA15S
Socket type 3: BA15S
Material: Shockproof plastic
Shape: Rectangular
Reflector: w/
Flasher light: w/
Rear/fog lamp: w/
Reverse light: w/
Tail light: w/
Stop light: w/
RH/LH: RH
E-approval: Yes

170893 Multi Function Lamp

Left: HC-CARGO 170895. 2 sockets for tail light. Lens: HC-CARGO 171062.

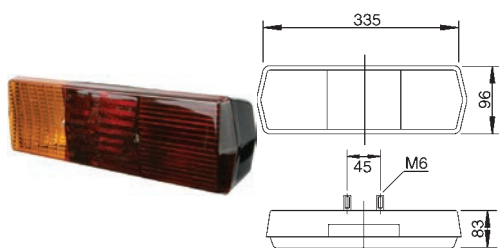

Bulb incl.: No
Watt: 21

Dim.: 335x96x83 mm
Dist. mount. holes:
45 mm

Socket type: BA15S
Material: Shockproof plastic
Shape: Rectangular
Flasher light: w/
Tail light: w/
Stop light: w/
RH/LH: RH

170895 Multi Function Lamp

Right: HC-CARGO 170893. 2 bulb holders for tail light. Lens: HC-CARGO 171062.

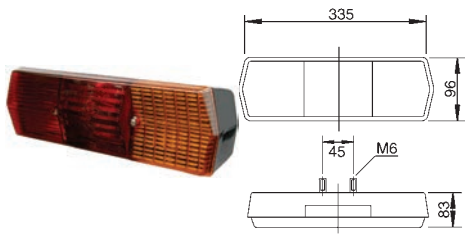

Bulb incl.: No
Watt: 21

Dim.: 335x96x83 mm
Dist. mount. holes:
45 mm

Socket type: BA15S
Material: Shockproof plastic
Shape: Rectangular
Flasher light: w/
Tail light: w/
Stop light: w/
RH/LH: LH

170916 Multi Function Lamp

Servicing: Scania, Universal - Visit www.hc-cargo.com for further information

Right: HC-CARGO 170917. 2 bulb holders for tail light. Lens: HC-CARGO 170968.

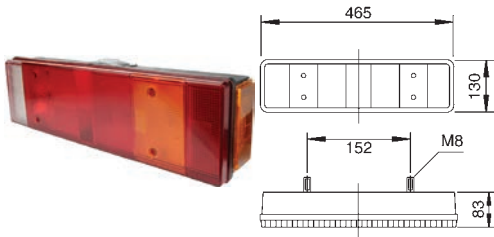

Watt: 21
Watt 2: 5
Watt 3: 10

Dim.: 465x130x83 mm
Dist. mount. holes:
152 mm

Socket type: BA15S
Socket type 2: BA15S
Socket type 3: BA15S
Material: Shockproof plastic
Shape: Rectangular
Reflector: w/
Flasher light: w/
Numberplate light: w/
Rear/fog lamp: w/
Reverse light: w/
Sidemarker lamp: w/
Tail light: w/
Stop light: w/
RH/LH: LH

170917 Multi Function Lamp

Servicing: Scania, Universal - Visit www.hc-cargo.com for further information

Left: HC-CARGO 170916. 2 bulb holders for tail light. Lens: HC-CARGO 170968.

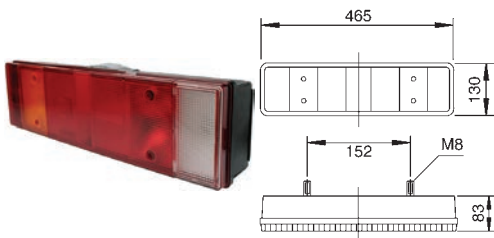

Watt: 21
Watt 2: 5
Watt 3: 10

Dim.: 465x130x83 mm
Dist. mount. holes:
152 mm

Socket type: BA15S
Socket type 2: BA15S
Socket type 3: BA15S
Material: Shockproof plastic
Shape: Rectangular
Reflector: w/
Flasher light: w/
Numberplate light: w/
Rear/fog lamp: w/
Reverse light: w/
Sidemarker lamp: w/
Tail light: w/
Stop light: w/
RH/LH: RH
E-approval: Yes

170922 Multi Function Lamp

Servicing: MAN, Universal - Visit www.hc-cargo.com for further information

Right: HC-CARGO 170923. Lens: HC-CARGO 170968.

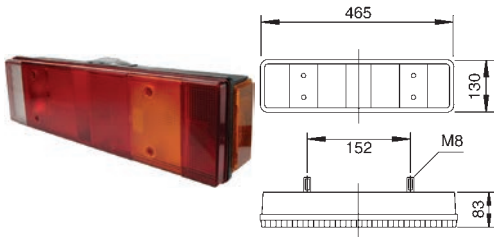

Watt: 21
Watt 2: 5
Watt 3: 10

Dim.: 465x130x83 mm
Dist. mount. holes:
152 mm

Socket type: BA15S
Socket type 2: BA15S
Socket type 3: BA15S
Material: Shockproof plastic
Shape: Rectangular
Reflector: w/
Flasher light: w/
Numberplate light: w/
Rear/fog lamp: w/
Sidemarker lamp: w/
Tail light: w/
Stop light: w/
RH/LH: LH
E-approval: Yes

170923 Multi Function Lamp

Servicing: MAN, Universal - Visit www.hc-cargo.com for further information

Left: HC-CARGO 170922. 2 bulb holders for tail light. Lens: HC-CARGO 170968.

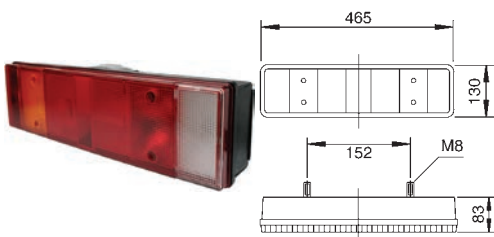

Watt: 21
Watt 2: 5
Watt 3: 10

Dim.: 465x130x83 mm
Dist. mount. holes:
152 mm

Socket type: BA15S
Socket type 2: BA15S
Socket type 3: BA15S
Material: Shockproof plastic
Shape: Rectangular
Reflector: w/
Flasher light: w/
Numberplate light: w/
Rear/fog lamp: w/
Reverse light: w/
Sidemarker lamp: w/
Tail light: w/
Stop light: w/
RH/LH: RH
E-approval: Yes

170990 Multi Function Lamp

Servicing: Commercial trailers - Visit www.hc-cargo.com for further information

Left: HC-CARGO 170991.

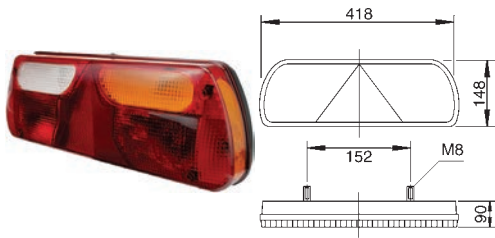

Bulb incl.: No
Watt: 21
Watt 2: 20/5
Watt 3: 5
Watt 4: 10

Dim.: 418x148x90 mm
Dist. mount. holes:
152 mm

Socket type: BA15S
Socket type 2: BAY15d
Socket type 3: BA15S
Socket type 4: BA10s
Material: Shockproof plastic
Shape: Rectangular
Reflector: w/
Flasher light: w/
Numberplate light: w/
Rear/fog lamp: w/
Sidemarker lamp: w/
Tail light: w/
Stop light: w/
RH/LH: RH
E-approval: Yes

170991 Multi Function Lamp

Servicing: Commercial trailers - Visit www.hc-cargo.com for further information

Right: HC-CARGO 170990. Lens: HC-CARGO 170995.

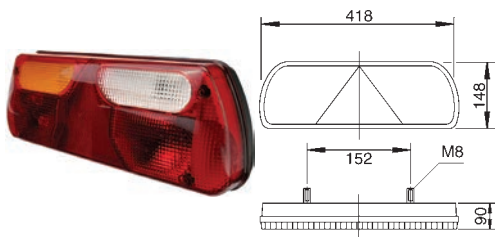

Bulb incl.: No
Watt: 21
Watt 2: 21/5
Watt 3: 5
Watt 4: 10

Dim.: 418x148x90 mm
Dist. mount. holes:
152 mm

Socket type: BA15S
Socket type 2: BAY15d
Socket type 3: BA15S
Socket type 4: BA10s
Material: Shockproof plastic
Shape: Rectangular
Reflector: w/
Flasher light: w/
Numberplate light: w/
Rear/fog lamp: w/
Sidemarker lamp: w/
Tail light: w/
Stop light: w/
RH/LH: LH
E-approval: Yes

170998 Multi Function Lamp

Servicing: Iveco - Visit www.hc-cargo.com for further information

Multi function lamp: HC-CARGO 170999. 2 bulb holders for tail light. Lens: HC-CARGO 171000.

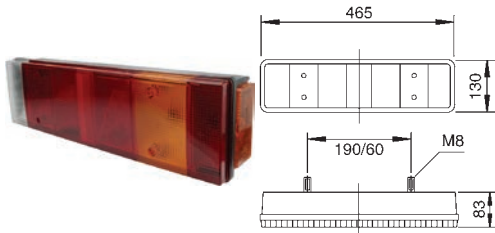

Bulb incl.: No
Watt: 21
Watt 2: 5

Dim.: 465x130x83 mm
Dist. mount. holes:
190/60 mm

Socket type: BA15S
Socket type 2: BA15S
Material: Shockproof plastic
Shape: Rectangular
Reflector: w/
Flasher light: w/
Rear/fog lamp: w/
Sidemarker lamp: w/
Tail light: w/
Stop light: w/
RH/LH: RH/LH
E-approval: Yes

170999 Multi Function Lamp

Servicing: Iveco - Visit www.hc-cargo.com for further information

Multi function lamp: HC-CARGO 170998. 2 bulb holders for tail light. Lens: HC-CARGO 171000.

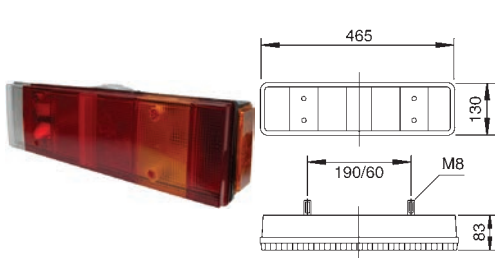

Bulb incl.: No
Watt: 21
Watt 2: 5
Watt 3: 10

Dim.: 465x130x83 mm
Dist. mount. holes:
190/60 mm

Socket type: BA15S
Socket type 2: BA15S
Socket type 3: BA15S
Material: Shockproof plastic
Shape: Rectangular
Reflector: w/
Flasher light: w/
Numberplate light: w/
Rear/fog lamp: w/
Sidemarker lamp: w/
Tail light: w/
Stop light: w/
RH/LH: RH/LH
E-approval: Yes

171188 Multi Function Lamp

Right: HC-CARGO 171189.

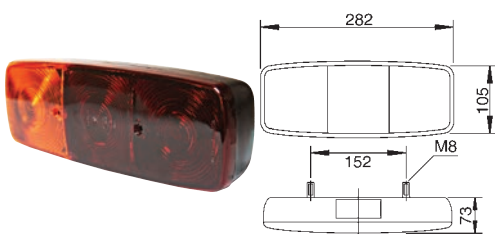

Bulb incl.: No
Watt: 21
Watt 2: 5
Watt 3: 10

Dim.: 282x105x73 mm
Dist. mount. holes:
152 mm

Socket type: BA15S
Socket type 2: BA15S
Socket type 3: BA15S
Material: Shockproof plastic
Shape: Rectangular
Flasher light: w/
Numberplate light: w/
Tail light: w/
Stop light: w/
RH/LH: LH

171189 Multi Function Lamp

Left: HC-CARGO 171188, 171190.

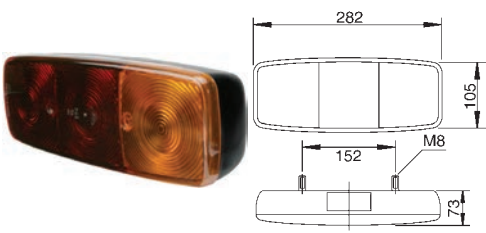

Bulb incl.: No
Watt: 21
Watt 2: 5

Dim.: 282x105x73 mm
Dist. mount. holes:
152 mm

Socket type: BA15S
Socket type 2: BA15S
Material: Shockproof plastic
Shape: Rectangular
Flasher light: w/
Tail light: w/
Stop light: w/
RH/LH: RH

171190 Multi Function Lamp

Right: HC-CARGO 171189.

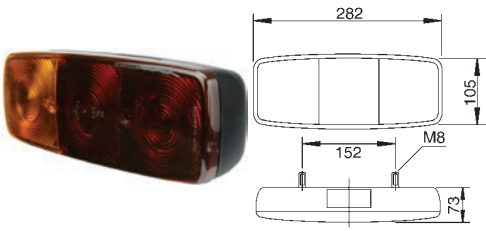

Bulb incl.: No
Watt: 21
Watt 2: 5

Dim.: 282x105x73 mm
Dist. mount. holes:
152 mm

Socket type: BA15S
Socket type 2: BA15S
Material: Shockproof plastic
Shape: Rectangular
Flasher light: w/
Tail light: w/
Stop light: w/
RH/LH: LH

171192 Multi Function Lamp

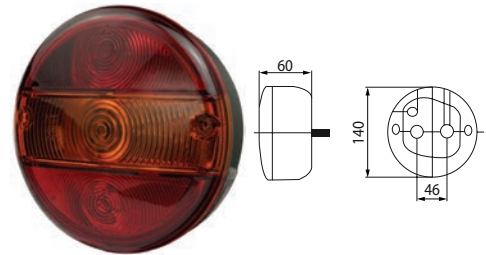

Bulb incl.: No

Dim.: 140x60 mm
Dist. mount. holes:
45 mm

Material: Shockproof plastic
Shape: Round
Fixing screw: 2
Flasher light: w/
Numberplate light: w/
Tail light: w/
Stop light: w/
E-approval: Yes

171193 Multi Function Lamp

Mounting kit: HC-CARGO 171266.

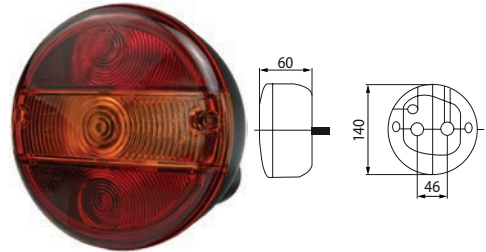

Bulb incl.: No

Dim.: 140x60 mm
Dist. mount. holes:
45 mm

Material: Shockproof plastic
Shape: Round
Fixing screw: 2
Flasher light: w/
Tail light: w/
Stop light: w/
E-approval: Yes

171194 Multi Function Lamp

Lens: HC-CARGO 171237.

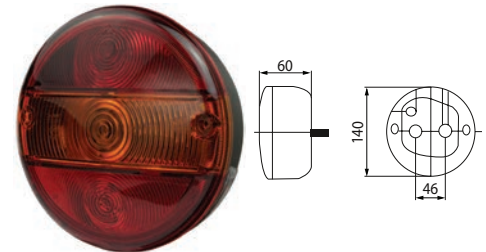

Bulb incl.: No
Watt: 21
Watt 2: 5

Dim.: 140x60 mm
Dist. mount. holes:
45 mm

Socket type: BA15S
Socket type 2: BA15S
Material: Shockproof plastic
Shape: Round
Fixing screw: 2
Flasher light: w/
Numberplate light: w/
Tail light: w/
Stop light: w/

171195 Multi Function Lamp

Mounting kit: HC-CARGO 171266.

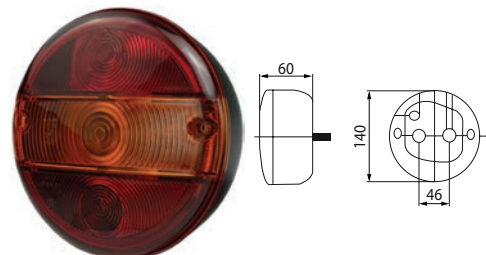

Bulb incl.: No

Dim.: 140x60 mm
Dist. mount. holes:
45 mm

Material: Shockproof plastic
Shape: Round
Fixing screw: 2

171205 Multi Function Lamp

Servicing: MAN, VW, Mercedes - Visit www.hc-cargo.com for further information

Left: HC-CARGO 171206. 2 bulb holders for tail light. Lens: HC-CARGO 171263.

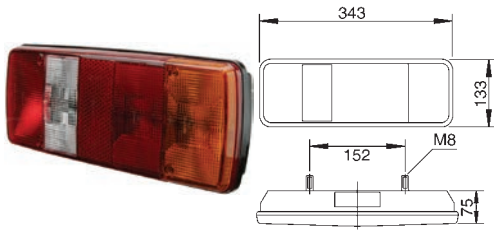

Bulb incl.: No
Watt: 21
Watt 2: 5

Dim.: 343x133x75 mm
Dist. mount. holes:
152 mm

Socket type: BA15S
Socket type 2: BA15S
Material: Shockproof plastic
Shape: Rectangular
Reflector: w/
Flasher light: w/
Rear/fog lamp: w/
Tail light: w/
Stop light: w/
RH/LH: RH

171206 Multi Function Lamp

Servicing: MAN, VW, Mercedes - Visit www.hc-cargo.com for further information

Right: HC-CARGO 171205. 2 bulb holders for tail light. Lens: HC-CARGO 171263.

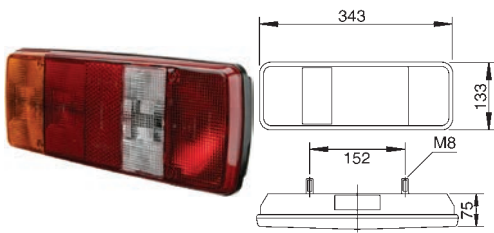

Bulb incl.: No
Watt: 21
Watt 2: 5

Dim.: 343x133x75 mm
Dist. mount. holes:
152 mm

Socket type: BA15S
Socket type 2: BA15S
Material: Shockproof plastic
Shape: Rectangular
Reflector: w/
Flasher light: w/
Numberplate light: w/
Rear/fog lamp: w/
Reverse light: w/
Tail light: w/
Stop light: w/
RH/LH: LH

171209 Multi Function Lamp

Right: HC-CARGO 171210.

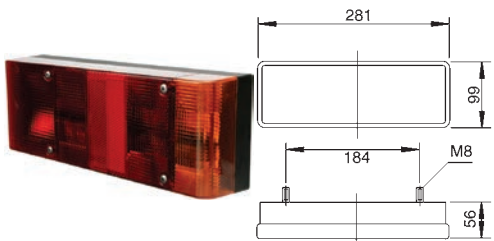

Bulb incl.: No
Watt: 21
Watt 2: 21/5
Watt 3: 5

Dim.: 281x99x56 mm
Dist. mount. holes:
184 mm

Socket type: BA15S
Socket type 2: BAY15d
Socket type 3: BA15S
Material: Shockproof plastic
Shape: Rectangular
Reflector: w/
Flasher light: w/
Numberplate light: w/
Rear/fog lamp: w/
Tail light: w/
Stop light: w/
RH/LH: LH

171210 Multi Function Lamp

Left: HC-CARGO 171209.

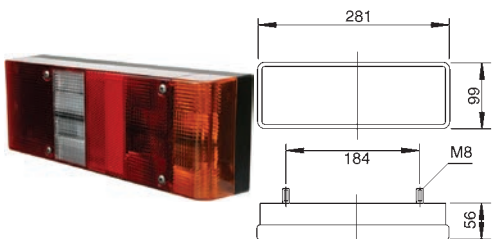

Bulb incl.: No
Watt: 21
Watt 2: 21/5
Watt 3: 5

Dim.: 281x99x56 mm
Dist. mount. holes:
184 mm

Socket type: BA15S
Socket type 2: BAY15d
Socket type 3: BA15S
Material: Shockproof plastic
Shape: Rectangular
Reflector: w/
Flasher light: w/
Numberplate light: w/
Reverse light: w/
Tail light: w/
Stop light: w/
RH/LH: RH

171299 Multi Function Lamp

Servicing: Mercedes Atego - Visit www.hc-cargo.com for further information

Left: HC-CARGO 171302. 2 bulb holders for tail light. Lens: HC-CARGO 171307.

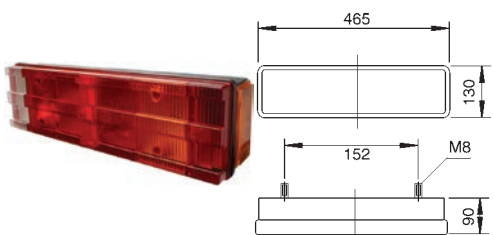

Bulb incl.: No
Watt: 21
Watt 2: 5
Watt 3: 10

Dim.: 465x130x90 mm
Dist. mount. holes:
152 mm

Socket type: BA15S
Socket type 2: BA15S
Socket type 3: BA15S
Material: Shockproof plastic
Shape: Rectangular
Reflector: w/
Flasher light: w/
Numberplate light: w/
Rear/fog lamp: w/
Sidemarker lamp: w/
Tail light: w/
Stop light: w/
RH/LH: RH
E-approval: Yes

171302 Multi Function Lamp

 Servicing: Mercedes Atego - Visit www.hc-cargo.com for further information

Right: HC-CARGO 171299. 2 bulb holders for tail light. Lens: HC-CARGO 171307.

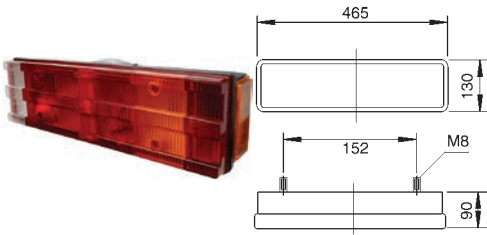
 Bulb incl.: No
 Watt: 21
 Watt 2: 5
 Watt 3: 10

 Dim.: 465x130x90 mm
 Dist. mount. holes:
 152 mm

 Socket type: BA15S
 Socket type 2: BA15S
 Socket type 3: BA15S
 Material: Shockproof plastic
 Shape: Rectangular
 Reflector: w/
 Flasher light: w/
 Numberplate light: w/
 Rear/fog lamp: w/
 Sidemarker lamp: w/
 Tail light: w/
 Stop light: w/
 RH/LH: LH
 E-approval: Yes

171303 Multi Function Lamp

 Servicing: Mercedes Sprinter - Visit www.hc-cargo.com for further information

Left: HC-CARGO 171306. 2 bulb holders for tail light. Lens: HC-CARGO 171307.

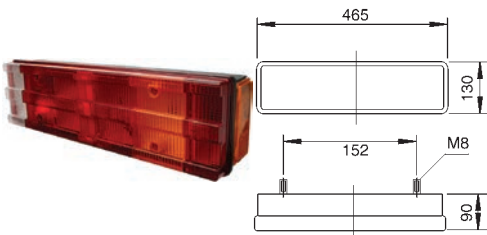
 Bulb incl.: No
 Watt: 21
 Watt 2: 5
 Watt 3: 10

 Dim.: 465x130x90 mm
 Dist. mount. holes:
 152 mm

 Socket type: BA15S
 Socket type 2: BA15S
 Socket type 3: BA15S
 Material: Shockproof plastic
 Shape: Rectangular
 Reflector: w/
 Flasher light: w/
 Numberplate light: w/
 Rear/fog lamp: w/
 Sidemarker lamp: w/
 Tail light: w/
 Stop light: w/
 RH/LH: RH
 E-approval: Yes

171306 Multi Function Lamp

 Servicing: Mercedes Sprinter - Visit www.hc-cargo.com for further information

Right: HC-CARGO 171303. 2 bulb holders for tail light. Lens: HC-CARGO 171307.

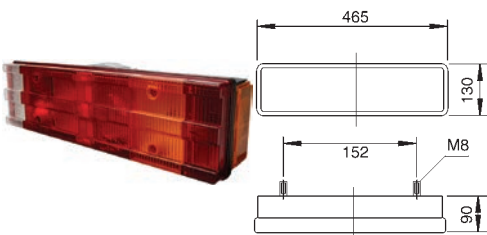
 Bulb incl.: No
 Watt: 21
 Watt 2: 5
 Watt 3: 10

 Dim.: 465x130x90 mm
 Dist. mount. holes:
 152 mm

 Socket type: BA15S
 Socket type 2: BA15S
 Socket type 3: BA15S
 Material: Shockproof plastic
 Shape: Rectangular
 Reflector: w/
 Flasher light: w/
 Numberplate light: w/
 Rear/fog lamp: w/
 Sidemarker lamp: w/
 Tail light: w/
 Stop light: w/
 RH/LH: LH
 E-approval: Yes

171308 Multi Function Lamp

 Servicing: Mercedes Actros - Visit www.hc-cargo.com for further information

Left: HC-CARGO 171311. Lens: HC-CARGO 171312.

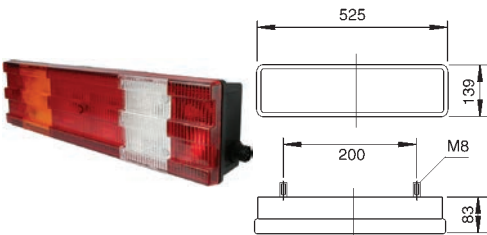
 Watt: 21
 Watt 2: 5
 Watt 3: 10

 Dim.: 525x139x83 mm
 Dist. mount. holes:
 200 mm

 Socket type: BA15S
 Socket type 2: BA15S
 Socket type 3: BA15S
 Material: Shockproof plastic
 Shape: Rectangular
 Reflector: w/
 Fixing screw: 12
 Flasher light: w/
 Numberplate light: w/
 Rear/fog lamp: w/
 Reverse light: w/
 Sidemarker lamp: w/
 Tail light: w/
 Stop light: w/
 RH/LH: RH
 E-approval: Yes

171311 Multi Function Lamp

 Servicing: Mercedes Actros - Visit www.hc-cargo.com for further information

Right: HC-CARGO 171308. Lens: HC-CARGO 171521.

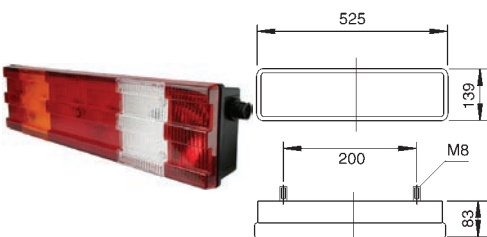

 Watt: 21
 Watt 2: 5
 Watt 3: 10

 Dim.: 525x139x83 mm
 Dist. mount. holes:
 200 mm

 Socket type: BA15S
 Socket type 2: BA15S
 Socket type 3: BA15S
 Material: Shockproof plastic
 Shape: Rectangular
 Reflector: w/
 Flasher light: w/
 Numberplate light: w/
 Rear/fog lamp: w/
 Reverse light: w/
 Sidemarker lamp: w/
 Tail light: w/
 Stop light: w/
 RH/LH: LH
 E-approval: Yes

171328 Multi Function Lamp

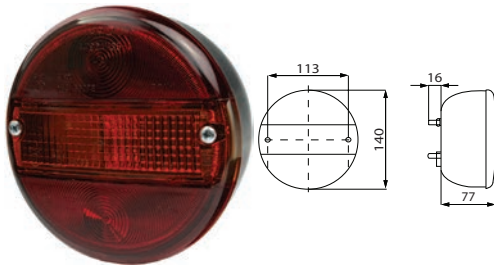
Lens: HC-CARGO 171330.



Bulb incl.: No
Watt: 21
Watt 2: 5

Dim.: 140x77 mm
Dist. mount. holes:
45 mm

Socket type: BA15S
Socket type 2: BA15S
Material: Shockproof plastic
Shape: Circular
Fixing screw: 2
Flasher light: w/
Numberplate light: w/
Tail light: w/
Stop light: w/
E-approval: Yes

171329 Multi Function Lamp

Mounting kit: HC-CARGO 171266. Lens: HC-CARGO 171330.

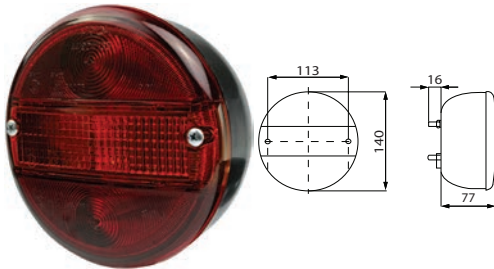

Bulb incl.: No

Dim.: 140x77 mm
Dist. mount. holes:
45 mm

Socket type: BA15S
Material: Shockproof plastic
Shape: Circular
Fixing screw: 2
Flasher light: w/
Tail light: w/
Stop light: w/
E-approval: Yes

171441 Multi Function Lamp

Servicing: Commercial trailers - Visit www.hc-cargo.com for further information

Right: HC-CARGO 171442. Lens: HC-CARGO 171446.

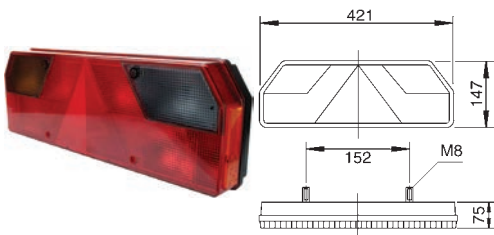

Bulb incl.: No
Watt: 21
Watt 2: 20/5
Watt 3: 10

Dim.: 421x147x75 mm
Dist. mount. holes:
152 mm

Socket type: BA15S
Socket type 2: BAY15d
Socket type 3: BA10s
Material: Shockproof plastic
Shape: Rectangular
Reflector: w/
Flasher light: w/
Numberplate light: w/
Tail light: w/
Stop light: w/
RH/LH: LH
E-approval: Yes

171442 Multi Function Lamp

Servicing: Commercial trailers - Visit www.hc-cargo.com for further information

Left: HC-CARGO 171441. Lens: HC-CARGO 171446.

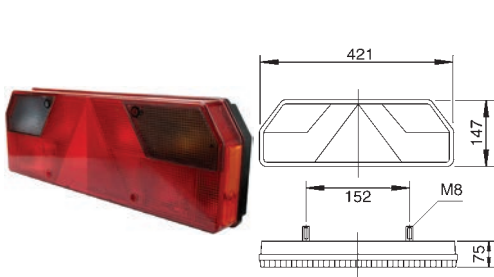

Bulb incl.: No
Watt: 21
Watt 2: 21/5
Watt 3: 5
Watt 4: 10

Dim.: 421x147x75 mm
Dist. mount. holes:
152 mm

Socket type: BA15S
Socket type 2: BAY15d
Socket type 3: BA15S
Socket type 4: BA10s
Material: Shockproof plastic
Shape: Rectangular
Reflector: w/
Flasher light: w/
Numberplate light: w/
Rear/fog lamp: w/
Sidemarker lamp: w/
Tail light: w/
Stop light: w/
RH/LH: RH
E-approval: Yes

171443 Multi Function Lamp

Servicing: Schwarzmüller - Visit www.hc-cargo.com for further information

Right: HC-CARGO 171444. Lens: HC-CARGO 171446.

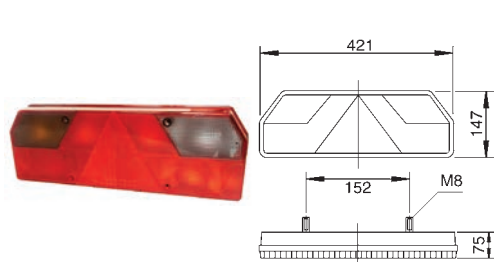

Bulb incl.: No
Watt: 21
Watt 2: 21/5
Watt 3: 5
Watt 4: 10

Dim.: 421x147x75 mm
Dist. mount. holes:
152 mm

Socket type: BA15S
Socket type 2: BAY15d
Socket type 3: BA15S
Socket type 4: BA10s
Material: Shockproof plastic
Shape: Rectangular
Reflector: w/
Flasher light: w/
Numberplate light: w/
Rear/fog lamp: w/
Sidemarker lamp: w/
Tail light: w/
Stop light: w/
RH/LH: LH

171444 Multi Function Lamp

Servicing: Schwarzmüller - Visit www.hc-cargo.com for further information

Left: HC-CARGO 171443. Lens: HC-CARGO 171446.

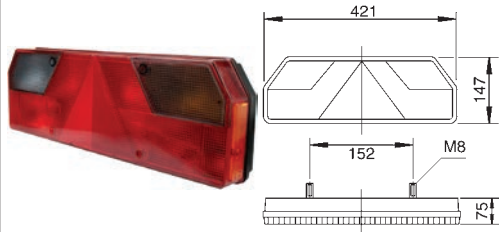

Bulb incl.: No
Watt: 21
Watt 2: 21/5
Watt 3: 5
Watt 4: 10

Dim.: 421x147x75 mm
Dist. mount. holes:
152 mm

Socket type: BA15S
Socket type 2: BAY15d
Socket type 3: BA15S
Socket type 4: BA10s
Material: Shockproof plastic
Shape: Rectangular
Reflector: w/
Flasher light: w/
Numberplate light: w/
Rear/fog lamp: w/
Sidemarker lamp: w/
Tail light: w/
Stop light: w/
RH/LH: RH

171447 Multi Function Lamp

Servicing: Mercedes Actros SK - Visit www.hc-cargo.com for further information

Right: HC-CARGO 171448. Lens: HC-CARGO 171521.

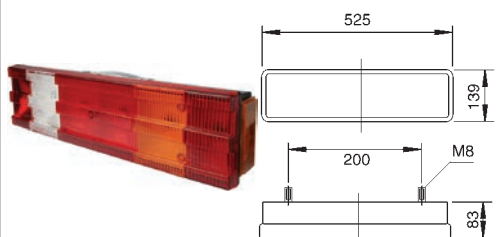

Bulb incl.: No
Watt: 21
Watt 2: 5
Watt 3: 10

Dim.: 525x139x83 mm
Dist. mount. holes:
200 mm

Socket type: BA15S
Socket type 2: BA15S
Socket type 3: BA15S
Material: Shockproof plastic
Shape: Rectangular
Reflector: w/
Flasher light: w/
Numberplate light: w/
Rear/fog lamp: w/
Reverse light: w/
Sidemarker lamp: w/
Tail light: w/
Stop light: w/
RH/LH: LH
E-approval: Yes

171448 Multi Function Lamp

Servicing: Mercedes Actros SK - Visit www.hc-cargo.com for further information

Left: HC-CARGO 171447. Lens: HC-CARGO 171312.

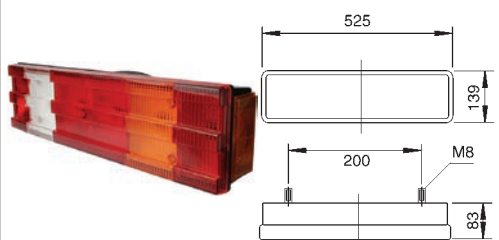

Bulb incl.: No
Watt: 21
Watt 2: 5
Watt 3: 10

Dim.: 525x139x83 mm
Dist. mount. holes:
200 mm

Socket type: BA15S
Socket type 2: BA15S
Socket type 3: BA15S
Material: Shockproof plastic
Shape: Rectangular
Reflector: w/
Flasher light: w/
Numberplate light: w/
Rear/fog lamp: w/
Reverse light: w/
Sidemarker lamp: w/
Tail light: w/
Stop light: w/
RH/LH: RH
E-approval: Yes

171506 Multi Function Lamp

Servicing: DAF, Nissan, Renault - Visit www.hc-cargo.com for further information

2 bulb holders for tail light. Lens: HC-CARGO 171507.

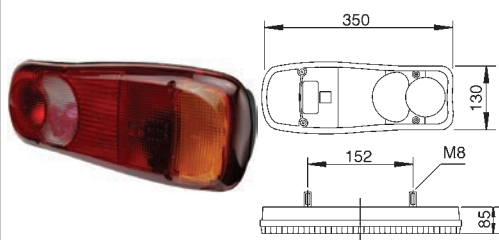

Bulb incl.: No
Watt: 21
Watt 2: 5
Watt 3: 10

Dim.: 350x130x85 mm
Dist. mount. holes:
152 mm

Socket type: BA15S
Socket type 2: BA15S
Socket type 3: BA15S
Material: Shockproof plastic
Shape: Rectangular
Reflector: w/
Flasher light: w/
Numberplate light: w/
Rear/fog lamp: w/
Reverse light: w/
Tail light: w/
Stop light: w/
RH/LH: RH/LH

171508 Multi Function Lamp

Servicing: Commercial trailers - Visit www.hc-cargo.com for further information

Optional use. 2 bulb holders for tail light. Lens: HC-CARGO 171507.

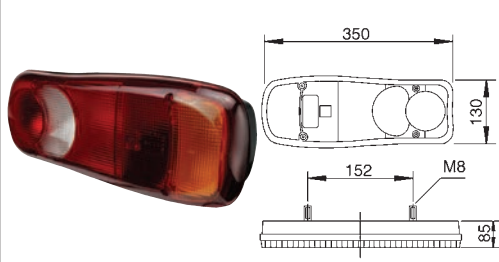

Bulb incl.: No
Watt: 21
Watt 2: 5
Watt 3: 10

Dim.: 350x130x85 mm
Dist. mount. holes:
152 mm

Socket type: BA15S
Socket type 2: BA15S
Socket type 3: BA15S
Material: Shockproof plastic
Shape: Rectangular
Flasher light: w/
Numberplate light: w/
Rear/fog lamp: w/
Reverse light: w/
Tail light: w/
Stop light: w/
RH/LH: RH/LH
Approvals: CE
E-approval: Yes

171700 Multi Function Lamp

Left: HC-CARGO 171701. Lens: HC-CARGO 171702.

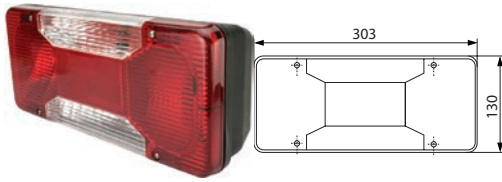

Bulb incl.: No
Voltage: 12/24

Dim.: 303x130x81 mm
Dist. mount. holes:
190 mm

Material: Shockproof plastic
Shape: Rectangular
Reflector: w/
Flasher light: w/
Numberplate light: w/o
Rear/fog lamp: w/
Reverse light: w/
Tail light: w/
Stop light: w/
RH/LH: RH
E-approval: Yes

171701 Multi Function Lamp

Right: HC-CARGO 171700. Lens: HC-CARGO 171702.

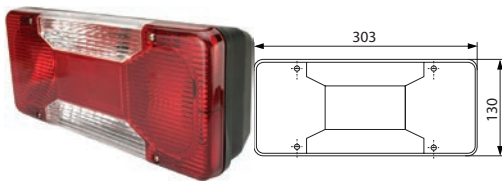

Bulb incl.: No
Voltage: 12/24

Dim.: 303x130x81 mm
Dist. mount. holes:
190 mm

Material: Shockproof plastic
Shape: Rectangular
Reflector: w/
Flasher light: w/
Numberplate light: w/o
Rear/fog lamp: w/
Reverse light: w/
Tail light: w/
Stop light: w/
RH/LH: LH
E-approval: Yes

171802 Multi Function Lamp

Servicing: Scania - Visit www.hc-cargo.com for further information

Left: HC-CARGO 171803. Multi plug: HC-CARGO 171788. Lens: HC-CARGO 171322.

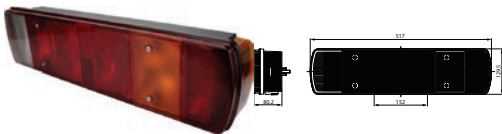

Bulb incl.: No
Watt: 21
Watt 2: 5

Dim.: 517x129.5x80.2 mm
Dist. mount. holes:
152 mm

Socket type: BA15S
Socket type 2: BA15S
Material: Shockproof plastic
Shape: Rectangular
Reflector: w/
Flasher light: w/
Numberplate light: w/
Rear/fog lamp: w/
Reverse light: w/
Sidemarker lamp: w/
Tail light: w/
Stop light: w/
RH/LH: RH
E-approval: Yes

171803 Multi Function Lamp

Servicing: Scania - Visit www.hc-cargo.com for further information

Right: HC-CARGO 171802. Multi plug: HC-CARGO 171788. Lens: HC-CARGO 171322.



Bulb incl.: No
Watt: 21
Watt 2: 5

Dim.: 517x129.5x80.2 mm
Dist. mount. holes:
152 mm

Socket type: BA15S
Socket type 2: BA15S
Material: Shockproof plastic
Shape: Rectangular
Reflector: w/
Flasher light: w/
Numberplate light: w/
Rear/fog lamp: w/
Reverse light: w/
Sidemarker lamp: w/
Tail light: w/
Stop light: w/
RH/LH: LH
E-approval: Yes

171806 Multi Function Lamp

Servicing: Trucks, Universal - Visit www.hc-cargo.com for further information

Right: HC-CARGO 171807. Lens: HC-CARGO 171810.

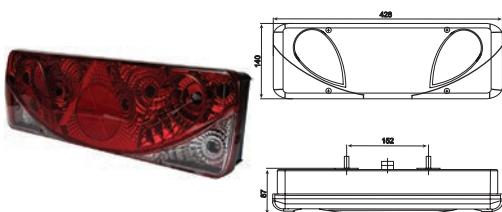

Bulb incl.: No
Watt: 21/5
Watt 2: 21
Watt 3: 21
Watt 4: 5

Dim.: 428x140x87 mm
Dist. mount. holes:
152 mm

Socket type: BAY15d
Socket type 2: BA15S
Socket type 3: BAU15s
Socket type 4: BA15S
Material: Shockproof plastic
Shape: Rectangular
Flasher light: w/
Rear/fog lamp: w/
Reverse light: w/
Sidemarker lamp: w/
Tail light: w/
Stop light: w/
RH/LH: LH
E-approval: Yes

171807 Multi Function Lamp

Servicing: Trucks, Universal - Visit www.hc-cargo.com for further information

Left: HC-CARGO 171806. Lens: HC-CARGO 171810.

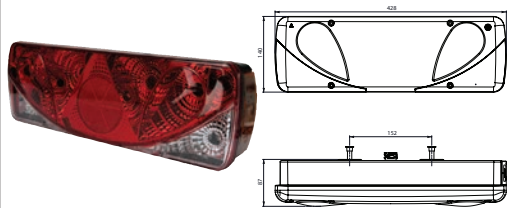

Bulb incl.: No
Watt: 21/5
Watt 2: 21
Watt 3: 21
Watt 4: 5

Dim.: 428x140x87 mm
Dist. mount. holes:
152 mm

Socket type: BAY15d
Socket type 2: BA15S
Socket type 3: BAU15s
Socket type 4: BA15S
Material: Shockproof plastic
Shape: Rectangular
Flasher light: w/
Rear/fog lamp: w/
Reverse light: w/
Sidemarker lamp: w/
Tail light: w/
Stop light: w/
RH/LH: RH
E-approval: Yes

171808 Multi Function Lamp

Servicing: Commercial trailers - Visit www.hc-cargo.com for further information

Right: HC-CARGO 171809. Lens: HC-CARGO 171810.

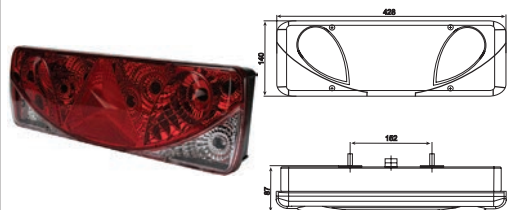

Bulb incl.: No
Watt: 21/5
Watt 2: 21
Watt 3: 21
Watt 4: 5

Dim.: 428x140x87 mm
Dist. mount. holes:
152 mm

Socket type: BAY15d
Socket type 2: BA15S
Socket type 3: BAU15s
Socket type 4: BA15S
Material: Shockproof plastic
Shape: Rectangular
Reflector: w/
Flasher light: w/
Rear/fog lamp: w/
Reverse light: w/
Sidemarker lamp: w/
Tail light: w/
Stop light: w/
RH/LH: LH
E-approval: Yes

171809 Multi Function Lamp

Servicing: Commercial trailers - Visit www.hc-cargo.com for further information

Left: HC-CARGO 171808. Lens: HC-CARGO 171810.

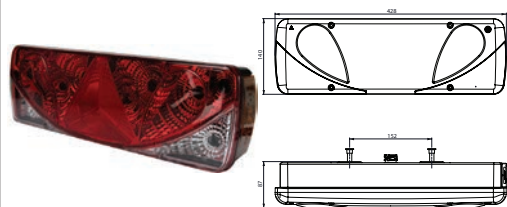

Bulb incl.: No
Watt: 21/5
Watt 2: 21
Watt 3: 21
Watt 4: 5

Dim.: 428x140x87 mm
Dist. mount. holes:
152 mm

Socket type: BAY15d
Socket type 2: BA15S
Socket type 3: BAU15s
Socket type 4: BA15S
Material: Shockproof plastic
Shape: Rectangular
Reflector: w/
Flasher light: w/
Rear/fog lamp: w/
Reverse light: w/
Sidemarker lamp: w/
Tail light: w/
Stop light: w/
RH/LH: RH
E-approval: Yes

171870 Multi Function Lamp

Servicing: HC-CARGO 171818, 171872

Multi connector: HC-CARGO 171372, 171373. Lens: HC-CARGO 171834. Right: HC-CARGO 171871.

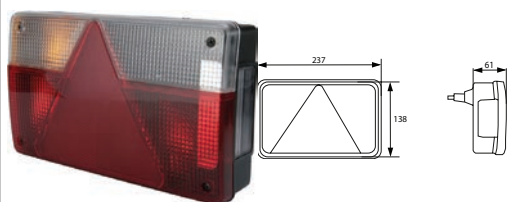

Bulb incl.: Yes
Voltage: 12

Dim.: 237x138x61 mm

Shape: Rectangular
Flasher light: w/
Numberplate light: w/
Rear/fog lamp: w/
Sidemarker: w/
Stop light: w/
RH/LH: LH
E-approval: Yes

171871 Multi Function Lamp

Servicing: HC-CARGO 171818, 171872

Multi Connector: HC-CARGO 171372, 171373. Lens: HC-CARGO 171833. Left: HC-CARGO 171872.

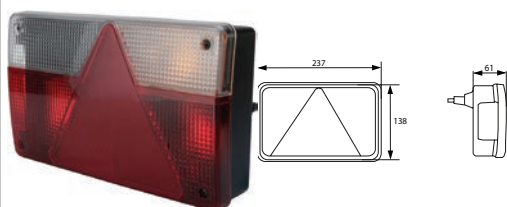







Bulb incl.: Yes
Voltage: 12

Dim.: 237x138x61 mm

Shape: Rectangular
Flasher light: w/
Numberplate light: w/
Rear/fog lamp: w/
Sidemarker: w/
Stop light: w/
RH/LH: RH
E-approval: Yes

	EL. SPECIFICATIONS	DIMENSIONS	ADDITIONAL SPECIFICATIONS
171917 Multi Function Lamp			
	Bulb incl.: No Watt: 5 Watt 2: 18 Watt 3: 18	Dim.: 115x54 mm Dist. mount. holes: 45 mm	Bulb type: 10.5x36 mm Bulb type 2: 15x41 mm Bulb type 3: 15x41 mm Socket type: S8.5 Socket type 2: S8.5 Socket type 3: S8.5 Colour/glass: Red/yellow Material/dome: PMMA Shape: Round Fixing screw: 2 Flasher light: w/ Tail light: w/ Stop light: w/ RH/LH: RH/LH
SPARE PARTS			
170665 Lens, Rear Lamp			
		Servicing: HC-CARGO 170602	
170910 Lens, Rear Lamp			
		Servicing: HC-CARGO 170909 Dim.: 140x26.8 mm Dist. mount. holes: 111 mm Colour: White Shape: Round	
170968 Lens, Rear Lamp			
		Servicing: HC-CARGO 170916, 170917 Dim.: 465x130 mm Shape: Rectangular	
171000 Lens, Rear Lamp			
		Servicing: HC-CARGO 170998, 170999 Dim.: 465x130x83 mm Shape: Rectangular	
171062 Lens, Rear Lamp			
		Servicing: HC-CARGO 170895, 170893 Dim.: 335x96 mm Material: Shockproof plastic Shape: Rectangular Numberplate light: w/	
171237 Lens, Rear Lamp			
		Servicing: HC-CARGO 171192, 171193, 171194, 171195 OD: 140 mm Type: Tail lamp Material: Plastic Shape: Circular RH/LH: RH/LH	

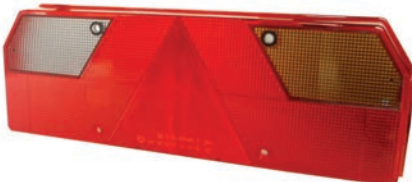
EL. SPECIFICATIONS	DIMENSIONS	ADDITIONAL SPECIFICATIONS
<p>171252 Lens, Rear Lamp</p> 	<p>Servicing: HC-CARGO 171201, 171199</p> <p>Dim.: 344x147 mm</p>	<p>Material: Shockproof plastic Shape: Rectangular</p>
<p>171263 Lens, Rear Lamp</p> 	<p>Servicing: HC-CARGO 171206, 171205</p> <p>Dim.: 343x133 mm</p>	<p>Material: Shockproof plastic Shape: Rectangular Reflector: w/ Numberplate light: w/</p>
<p>171307 Lens, Rear Lamp</p> 	<p>Servicing: HC-CARGO 171299, 171302, 171303, 171306</p> <p>Dim.: 465x130 mm</p>	<p>Shape: Rectangular</p>
<p>171312 Lens, Rear Lamp</p> 	<p>Servicing: HC-CARGO 171308</p> <p>Dim.: 525x139 mm</p>	<p>Shape: Rectangular Reflector: w/</p>
<p>171322 Lens, Rear Lamp</p> 	<p>Servicing: HC-CARGO 171802, 171803</p> <p>Dim.: 516x130 mm Dist. mount. holes: 152 mm</p>	<p>Shape: Rectangular</p>
<p>171330 Lens, Rear Lamp</p> 	<p>Servicing: HC-CARGO 171328, 171329</p> <p>OD: 140 mm</p>	<p>Shape: Circular RH/LH: RH/LH</p>
<p>171446 Lens, Rear Lamp</p> 	<p>Servicing: HC-CARGO 171443, 171444</p> <p>Dim.: 421x147 mm</p>	<p>Shape: Rectangular Reflector: w/ Numberplate light: w/</p>

EL. SPECIFICATIONS	DIMENSIONS	ADDITIONAL SPECIFICATIONS
<p>171507 Lens, Rear Lamp</p> 	<p>Servicing: HC-CARGO 171506, 171508</p> <p>Dim.: 350x130 mm</p>	<p>Material: Shockproof plastic Shape: Rectangular Reflector: w/ Numberplate light: w/</p>
<p>171521 Lens, Rear Lamp</p> 	<p>Servicing: HC-CARGO 171311</p> <p>Dim.: 525x139 mm</p>	<p>Shape: Rectangular Reflector: w/</p>
<p>171702 Lens, Rear Lamp</p> 	<p>Servicing: HC-CARGO 171700, 171701</p> <p>Dim.: 303x130 mm</p>	<p>Material: Shockproof plastic Shape: Rectangular Reflector: w/ RH/LH: RH</p>
<p>171703 Lens, Rear Lamp</p> 	<p>Servicing: HC-CARGO 171701</p> <p>Dim.: 303x130 mm</p>	<p>Material: Shockproof plastic Shape: Rectangular Reflector: w/ RH/LH: LH</p>
<p>171810 Lens, Rear Lamp</p> 	<p>Servicing: HC-CARGO 171806, 171807, 171808, 171809</p> <p>Dim.: 428x140 mm</p>	
<p>ACCESSORIES</p>		
<p>171788 Multiconnector 7 pin</p> <p>Gasket: HC-CARGO 192178.</p> 	<p>Servicing: HC-CARGO 171756, 171757</p>	<p>Type/terminal: Round Colour: Black No./poles: 7 Plug: Female</p>
<p>181627 Bayonet connector</p> 	<p>Servicing: HC-CARGO 181617</p> <p>Voltage: 12</p>	<p>Mount.: Terminal No./poles: 8</p>

ACCESSORIES - Lighting

O.E.M. names and numbers are used for reference purposes only.

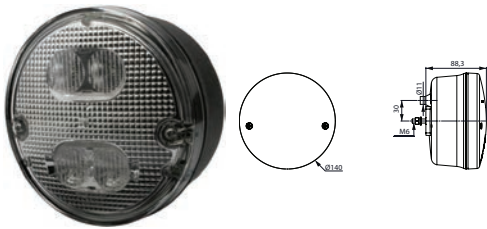
TRAILER LAMPS LED (TRUCKS)
170909 LED Fog/Reverse Lamp
Lens and o-ring: HC-CARGO 170910.

Voltage: 12/24

Dim.: 140x88.3 mm
Dist. mount. holes:
 45 mm

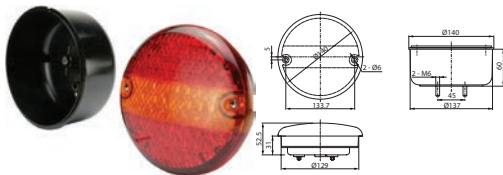
Type: LED
Colour/glass: White
Material: Shockproof plastic
Shape: Round
Fixing screw: 2
Rear/fog lamp: w/
Tail light: w/
LEDs: w/
No./LEDs: 4
E-approval: Yes

171549 LED Multifunction Lamp
Mounting kit: HC-CARGO 171266.

Voltage: 9-33

Dim.: 140x52.5 mm
Dist. mount. holes:
 45 mm

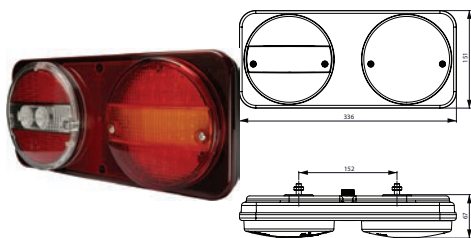
Type: LED
Colour: Black
Material: Shockproof plastic
Shape: Circular
Fixing screw: 2
Flasher light: w/
Tail light: w/
Stop light: w/
No./LEDs: 63
E-approval: Yes

171665 LED Multifunction Lamp
Right: HC-CARGO 171666.

Voltage: 12/24

Dim.: 336x151x67 mm
Dist. mount. holes:
 152 mm

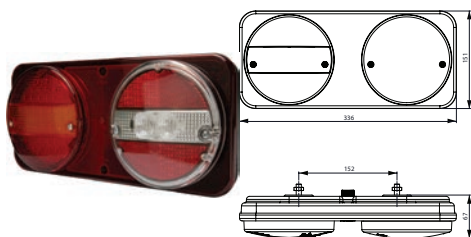
Type: LED
Material: Shockproof plastic
Shape: Rectangular
Reflector: w/
Flasher light: w/
Reverse light: w/
Tail light: w/
Stop light: w/
RH/LH: LH
E-approval: Yes

171666 LED Multifunction Lamp
Left: HC-CARGO 171665.

Voltage: 12/24

Dim.: 336x151x67 mm
Dist. mount. holes:
 152 mm

Type: LED
Material: Shockproof plastic
Shape: Rectangular
Reflector: w/
Flasher light: w/
Reverse light: w/
Tail light: w/
Stop light: w/
RH/LH: RH
E-approval: Yes

171725 LED Tail-Position Lamp
Ring: amber, center: red.

Voltage: 12/24

Dim.: 122x84.5 mm
Cable length: 150 mm
Dist. mount. holes:
 44 mm

Type: LED
Material: Shockproof plastic
Material/dome: Shockproof plastic
Shape: Round
Fixing screw: 6
Flasher light: w/
Tail light: w/
Stop light: w/
No./LEDs: 44
E-approval: Yes

171726 LED Fog/Reverse Lamp
Ring: clear, center: red.

Voltage: 12/24

Dim.: 122x84.5 mm
Cable length: 150 mm
Dist. mount. holes:
 44 mm

Type: LED
Material: Shockproof plastic
Material/dome: Shockproof plastic
Rear/fog lamp: w/
Reverse light: w/
No./LEDs: 38
E-approval: Yes

171927 LED Multifunction Lamp

Left: HC-CARGO 171928. Multi-plug: HC-CARGO 171788.

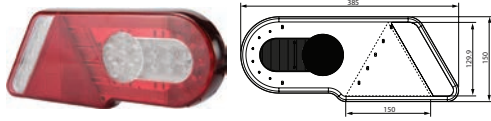

Voltage: 12-24

Dim.: 385x150x34.1 mm
Dist. mount. holes:
152.3 mm

Type: LED
Shape: Rectangular
Reflector: w/
Flasher light: w/
Rear/fog lamp: w/
Reverse light: w/
Tail light: w/
Stop light: w/
RH/LH: RH
Tightness norm: IP 67
Approvals: CE
E-approval: Yes

171928 LED Multifunction Lamp

Right: HC-CARGO 171927. Multi-plug: HC-CARGO 171788.

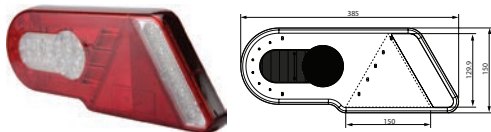

Voltage: 12-24

Dim.: 385x150x34.1 mm
Dist. mount. holes:
152 mm

Type: LED
Shape: Rectangular
Reflector: w/
Flasher light: w/
Rear/fog lamp: w/
Reverse light: w/
Tail light: w/
Stop light: w/
RH/LH: LH
Tightness norm: IP 67
Approvals: CE
E-approval: Yes

171929 LED Multifunction Lamp

Left: HC-CARGO 171930. Multi-plug: HC-CARGO 171788.



Voltage: 12-24

Dim.: 240.3x140x31 mm
Dist. mount. holes:
152 mm

Type: LED
Shape: Rectangular
Reflector: w/
Flasher light: w/
Rear/fog lamp: w/
Reverse light: w/
Tail light: w/
Stop light: w/
RH/LH: RH
Tightness norm: IP 67
Approvals: CE
E-approval: Yes

171930 LED Multifunction Lamp

Right: HC-CARGO 171929. Multi-plug: HC-CARGO 171788.



Voltage: 12-24

Dim.: 240.3x140x31 mm
Dist. mount. holes:
152 mm

Type: LED
Shape: Rectangular
Reflector: w/
Flasher light: w/
Rear/fog lamp: w/
Reverse light: w/
Tail light: w/
Stop light: w/
RH/LH: LH
Tightness norm: IP 67
Approvals: CE
E-approval: Yes

171952 LED Multifunction Lamp

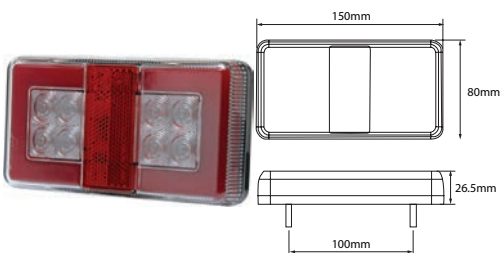

Voltage: 12-24

Dim.: 150x80x26.5 mm
Cable length: 300 mm
Dist. mount. holes:
100 mm

Mount.: 2 screws
Reflector: w/
No./reflectors: 1
Flasher light: w/
Tail light: w/
Stop light: w/
Tightness norm: IP 67
Approvals: CE
E-approval: Yes

ACCESSORIES
160970 Load Resistor 12 V

Voltage: 12
Watt: 50
Amp: 2
Ohm: 6

Length: 50 mm
Width: 15 mm

160971 Load Resistor 24 V

Voltage: 24
Watt: 50
Amp: 1
Ohm: 24

Length: 50 mm
Width: 15 mm

TRAILER LAMPS (TRUCKS) W/ LED
171550 LED Multifunction Lamp

w/ transparent lens when light is off. Mounting kit: HC-CARGO 171266.

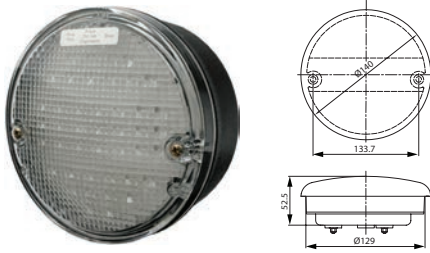

Voltage: 9-33

Dim.: 140x52.5 mm
Dist. mount. holes:
45 mm

Type: LED
Material: Shockproof plastic
Shape: Round
Fixing screw: 2
Flasher light: w/
Tail light: w/
Stop light: w/
No./LEDs: 63
E-approval: Yes

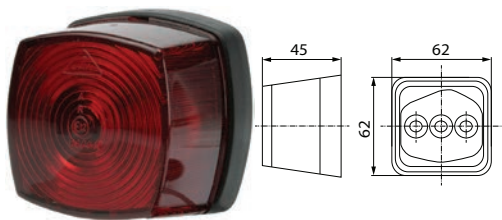
TAIL LAMPS CONVENTIONAL
171173 Tail Lamp

Watt: 5

Dim.: 62x62x45 mm
Dist. mount. holes:
30 mm

Socket type: S8.5
Colour/glass: Red
Material: Shockproof plastic
Shape: Rectangular
Fixing screw: 2
Sidemarker: w/
E-approval: Yes

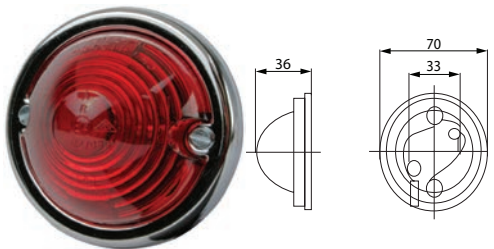
171178 Tail Lamp

Watt: 5

Dim.: 70x36 mm
Dist. mount. holes:
33 mm



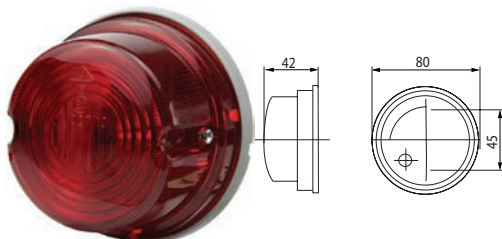





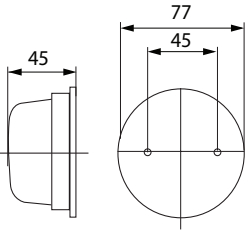

Socket type: S8.5
Colour/glass: Red
Material: Steel
Fixing screw: 2
E-approval: Yes

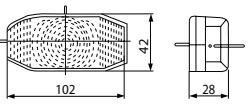
171181 Tail Lamp

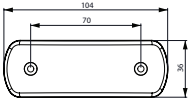
Watt: 5

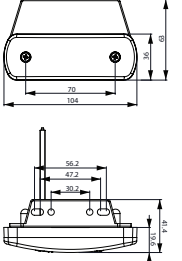
Dim.: 80x42 mm
Dist. mount. holes:
45 mm

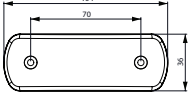
Socket type: S8.5
Colour/glass: Red
Material: Shockproof plastic
Fixing screw: 2
E-approval: Yes

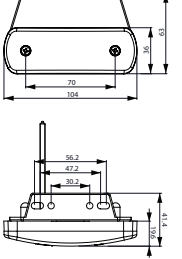
	EL. SPECIFICATIONS	DIMENSIONS	ADDITIONAL SPECIFICATIONS	
171197 Tail Lamp			Watt: 5 Dim.: 77x45 mm Dist. mount. holes: 45 mm	Socket type: S8.5 Colour/glass: Red Material: Metal Shape: Circular Fixing screw: 2 Numberplate light: w/
171331 Tail Lamp			Watt: 5 Dim.: 102x42x28 mm Dist. mount. holes: 65 mm	Socket type: S8.5 Colour/glass: Red Material: Plastic Fixing screw: 2 E-approval: Yes
TAIL LAMPS LED				
171579 LED Tail Lamp			Voltage: 12 Dim.: 104x36x20 mm Cable length: 500 mm Dist. mount. holes: 70 mm	Type: LED Colour/glass: Red Material: Shockproof plastic Shape: Rectangular Reflector: w/ Fixing screw: 2 Tail light: w/ No./LEDs: 3 E-approval: Yes
171580 LED Tail Lamp			Voltage: 12 Dim.: 104x36x19.6 mm Cable length: 500 mm Dist. mount. holes: 70 mm	Type: LED Colour/glass: Red Material: Shockproof plastic Shape: Rectangular Bracket: Angled Reflector: w/ Fixing screw: 2 Tail light: w/ No./LEDs: 3 E-approval: Yes
171599 LED Tail Lamp			Voltage: 24 Dim.: 104x36x20 mm Cable length: 500 mm Dist. mount. holes: 70 mm	Type: LED Colour/glass: Red Material: Shockproof plastic Shape: Rectangular Reflector: w/ Fixing screw: 2 Tail light: w/ No./LEDs: 3 E-approval: Yes
171600 LED Tail Lamp			Voltage: 24 Dim.: 104x36x19.6 mm Cable length: 500 mm Dist. mount. holes: 70 mm	Type: LED Colour/glass: Red Material: Shockproof plastic Shape: Rectangular Bracket: Angled Reflector: w/ Fixing screw: 2 Tail light: w/ No./LEDs: 3 E-approval: Yes

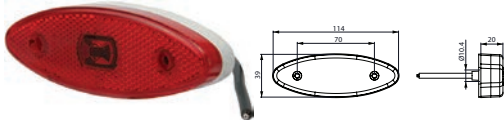
171605 LED Tail Lamp

Voltage: 24

Dim.: 114x39x20 mm
Cable length: 500 mm
Dist. mount. holes: 70 mm

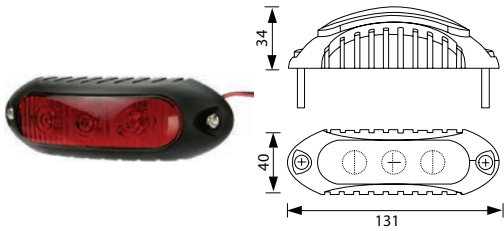
Type: LED
Colour/glass: Red
Material: Shockproof plastic
Shape: Oval
Reflector: w/
Fixing screw: 2
Tail light: w/
No./LEDs: 3
Approvals: ADR
E-approval: Yes

171635 LED Tail Lamp

Voltage: 9-36

Dim.: 131x40x34 mm
Dist. mount. holes: 115 mm

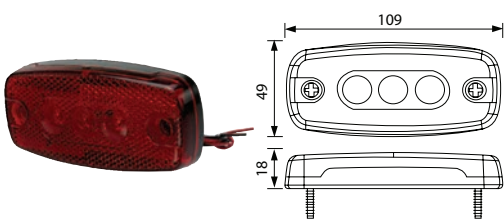
Type: LED
Colour/glass: Red
Material: PP/PMMA
Shape: Oval
Tail light: w/
No./LEDs: 3
E-approval: Yes

171637 LED Tail Lamp

Voltage: 9-36
Watt: 0.9

Dim.: 109x49x18 mm
Dist. mount. holes: 83 mm

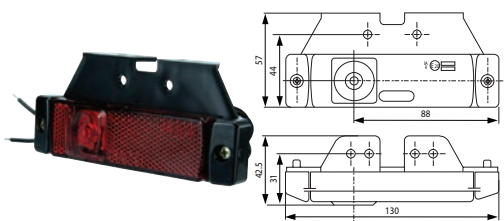
Type: LED
Colour/glass: Red
Shape: Rectangular
Reflector: w/
Tail light: w/
No./LEDs: 3
E-approval: Yes

171719 LED Tail Lamp

Voltage: 12/24

Dim.: 130x57x42.5 mm
Dist. mount. holes: 50 mm

Type: LED
Colour/glass: Red
Material: Shockproof plastic
Shape: Rectangular
Bracket: Angled
Reflector: w/
Tail light: w/
No./LEDs: 1
E-approval: Yes

171720 LED Tail Lamp

Voltage: 12/24





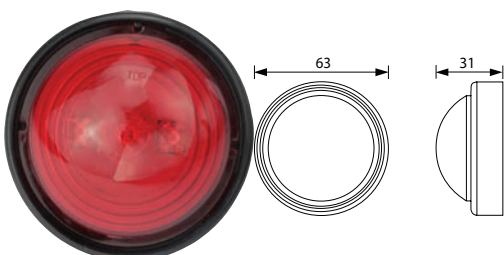



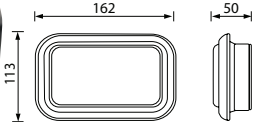

Dim.: 130x32x20.5 mm
Dist. mount. holes: 50 mm

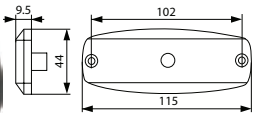
Type: LED
Colour/glass: Red
Material: Shockproof plastic
Shape: Rectangular
Reflector: w/
Tail light: w/
No./LEDs: 1
E-approval: Yes

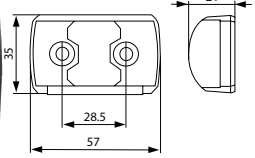
171743 LED Tail Lamp

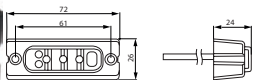
Voltage: 9-36

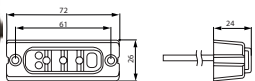
Dim.: 63x31 mm
Cable length: 300 mm
Dist. mount. holes: 30 mm

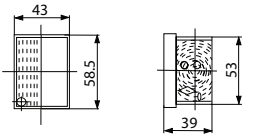
Type: LED
Colour: Black
Colour/glass: Red
Material: PVC
Material/dome: PMMA
Mount.: 2 screws
Tail light: w/
No./LEDs: 3
Approvals: ADR/SAE
E-approval: Yes

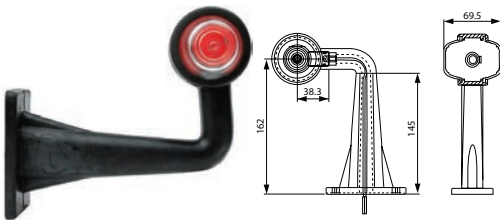
	EL. SPECIFICATIONS	DIMENSIONS	ADDITIONAL SPECIFICATIONS
171771 LED Tail Lamp	 	Voltage: 24 Watt: 2.5 Dim.: 162x113x50 mm	Type: Tail lamp Colour/glass: Red Material: ABS plastic Material/dome: PMMA Shape: Rectangular Mount.: Plan installation Tail light: w/ Stop light: w/ No./LEDs: 16 RH/LH: RH/LH E-approval: Yes
171840 LED Tail Lamp	 	Voltage: 12/24 Watt: 0.45-1.6 Dim.: 115x44x9.5 mm Cable length: 5000 mm Dist. mount. holes: 102 mm	Type: LED Colour: White Colour/glass: Red Material: Polycarbonate Material/dome: Polycarbonate Shape: Rectangular Mount.: 2 screws Reflector: w/ Tail light: w/ No./LEDs: 3 Tightness norm: IP 67 Approvals: SAE E-approval: Yes
171843 LED Tail Lamp	 	Voltage: 12/24 Dim.: 57x35x21 mm Cable length: 400 mm Dist. mount. holes: 28 mm	Type: LED Colour: Black Colour/glass: Red Shape: Rectangular Fixing screw: 2 Tail light: w/ No./LEDs: 2 Tightness norm: IP 67 E-approval: Yes
171861 LED Tail Lamp	 	Voltage: 12/24 Watt: 0.3-0.6 Dim.: 72x26x24 mm Cable length: 5000 mm	Type: LED Colour: Black Colour/glass: Red Material: PP Material/dome: PMMA Shape: Rectangular Fixing screw: 2 Tail light: w/ No./LEDs: 3 Approvals: CE E-approval: Yes
171867 LED Tail Lamp	 	Voltage: 12/24 Watt: 0.3-0.6 Dim.: 72x26x24 mm Cable length: 5000 mm	Type: LED Colour: Black Colour/glass: Red Material: PP Material/dome: PMMA Shape: Rectangular Bracket: Adjustable Fixing screw: 2 Tail light: w/ No./LEDs: 3 Approvals: CE E-approval: Yes
TAIL POSITION LAMPS CONVENTIONAL			
170552 Tail/Position Lamp	 	Watt: 5 Dim.: 58.5x43x39 mm Dist. mount. holes: 25 mm	Socket type: S8.5 Colour/glass: Red/white Material: Shockproof plastic Shape: Rectangular Fixing screw: 2 Sidemarker: w/ Tail light: w/ RH/LH: RH/LH E-approval: Yes

170632 Tail/Position Lamp
Lens: HC-CARGO 170635, 170636.

Bulb incl.: No
Watt: 10

Dim.: 162x69.5 mm
Dist. mount. holes: 76 mm

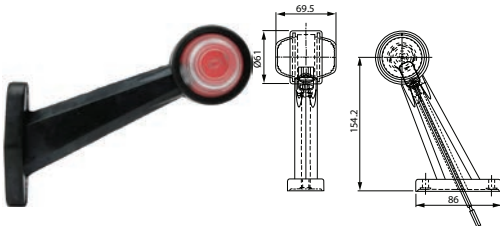
Socket type: BA15S
Colour/glass: Red/white
Sidemarkers: w/
Tail light: w/
E-approval: Yes

170633 Tail/Position Lamp
Lens: HC-CARGO 170635, 170636.

Bulb incl.: No
Watt: 10

Dim.: 154.2x69.5 mm
Dist. mount. holes: 75 mm

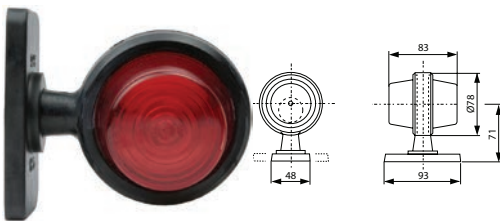
Socket type: BA15S
Colour/glass: Red/white
Sidemarkers: w/
Tail light: w/
E-approval: Yes

170640 Tail/Position Lamp
Lens: HC-CARGO 170642, 170641. Bulb holder: HC-CARGO 170671.

Bulb incl.: No
Watt: 5

Dim.: 110x78x93 mm
Dist. mount. holes: 75 mm

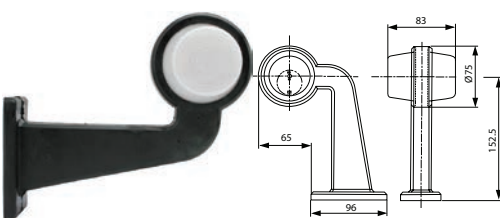
Socket type: BA15S
Colour/glass: Red/white
Shape: Round
Sidemarkers: w/
Tail light: w/
E-approval: Yes

170668 Tail/Position Lamp
Lens: HC-CARGO 170642, 170641. Bulb holder: HC-CARGO 170671. Bulbs: HC-CARGO 170773.

Bulb incl.: No
Watt: 5

Dim.: 152.5x83 mm
Dist. mount. holes: 74 mm

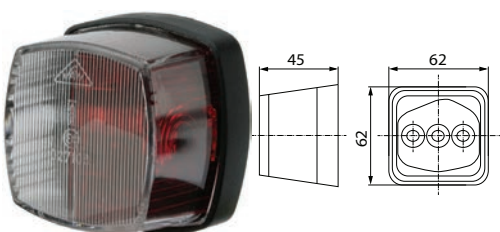
Socket type: BA15S
Colour/glass: Red/white
Sidemarkers: w/
Tail light: w/
E-approval: Yes

171196 Tail/Position Lamp

Watt: 5

Dim.: 62x62x45 mm
Dist. mount. holes: 30 mm

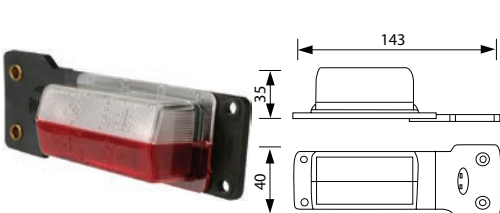
Socket type: S8.5
Colour/glass: Red/white
Material: Shockproof plastic
Shape: Square
Fixing screw: 2
Sidemarkers: w/
Tail light: w/
RH/LH: RH/LH
E-approval: Yes

171627 Tail/Position Lamp

Bulb incl.: No
Voltage: 12/24
Watt: 5

Dim.: 143x40x35 mm
Dist. mount. holes: 30 mm

Socket type: S8.5
Material: Plastic
Shape: Rectangular
Sidemarkers: w/
Tail light: w/
Approvals: ADR
E-approval: Yes

EL. SPECIFICATIONS		DIMENSIONS	ADDITIONAL SPECIFICATIONS
171706 Tail/Position Lamp			
Servicing: HC-CARGO 171627			
	Bulb incl.: No Voltage: 12/24 Watt: 5	Dim.: 74x40x37 mm Dist. mount. holes: 45 mm	Socket type: S8.5 Shape: Rectangular Sidemarkers: w/ Tail light: w/ Approvals: ADR E-approval: Yes
SPARE PARTS			
170635 Lens			
Servicing: HC-CARGO 170632, 170633			
			Colour/glass: White Material: Glass Shape: Round
170636 Lens			
Servicing: HC-CARGO 170632, 170633			
			Colour/glass: Red Material: Glass Shape: Round
170641 Lens			
Servicing: HC-CARGO 170640, 170668			
			Colour/glass: Red Material: Glass Shape: Round
170642 Lens			
Servicing: HC-CARGO 170640, 170668			
			Colour/glass: White Material: Glass
170671 Bulb Holder			
Servicing: HC-CARGO 170640, 170668, 170713			
TAIL POSITION LAMPS LED			
171528 LED Tail-Position Lamp			
	Voltage: 24	Dim.: 181x154x48 mm Cable length: 700 mm Dist. mount. holes: 73 mm	Type: LED Colour/glass: Red/white Material: Rubber Material/dome: Shockproof plastic Fixing screw: 2 Sidemarkers: w/ Tail light: w/ No./LEDs: 2x1 RH/LH: RH/LH E-approval: Yes

171529 LED Tail-Position Lamp

Flange 100x41 mm.

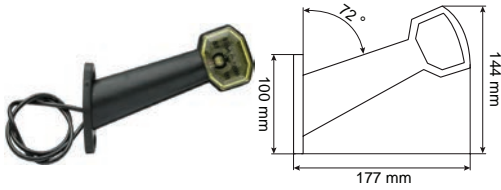

Voltage: 24

 Dim.: 177x144x48 mm
 Cable length: 700 mm
 Dist. mount. holes:
 73 mm

 Type: LED
 Colour/glass: Red/white
 Material: Rubber
 Material/dome: Shockproof plastic
 Fixing screw: 2
 Sidemarker: w/
 Tail light: w/
 No./LEDs: 2x1
 RH/LH: RH/LH
 E-approval: Yes

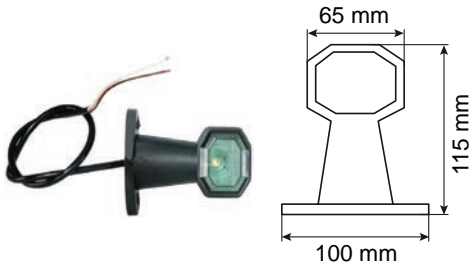
171530 LED Tail-Position Lamp

Voltage: 24

 Dim.: 115x65x48 mm
 Cable length: 700 mm
 Dist. mount. holes:
 73 mm

 Type: LED
 Colour/glass: Red/white
 Material: Rubber
 Material/dome: Shockproof plastic
 Fixing screw: 2
 Sidemarker: w/
 Tail light: w/
 No./LEDs: 2x1
 RH/LH: RH/LH
 E-approval: Yes

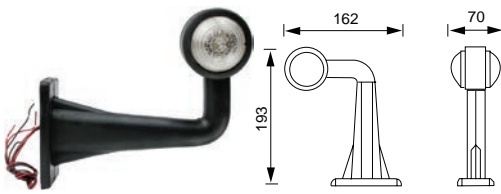
171591 LED Tail-Position Lamp

Voltage: 9-36

 Dim.: 193x162x70 mm
 Dist. mount. holes:
 78 mm

 Type: LED
 Colour/glass: Red/white
 Sidemarker: w/
 Tail light: w/
 No./LEDs: 2x3
 RH/LH: RH/LH
 Approvals: ADR/SAE
 E-approval: Yes

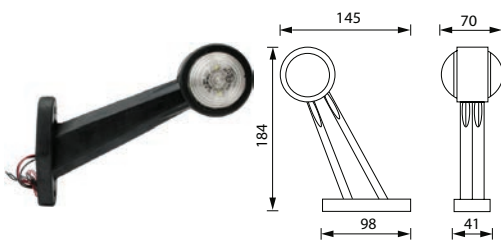
171592 LED Tail-Position Lamp

Voltage: 9-36

 Dim.: 184x145x70 mm
 Dist. mount. holes:
 78 mm

 Type: LED
 Colour/glass: Red/white
 Sidemarker: w/
 Tail light: w/
 No./LEDs: 2x3
 RH/LH: RH/LH
 Approvals: SAE
 E-approval: Yes

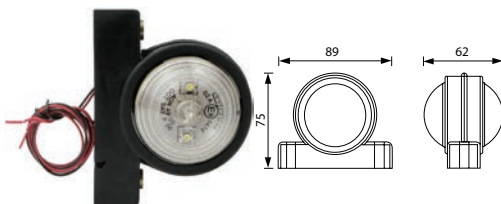
171593 LED Tail-Position Lamp

Voltage: 9-36

 Dim.: 75x89x62 mm
 OD: 45 mm
 Dist. mount. holes:
 78 mm

 Type: LED
 Colour/glass: Red/white
 Material: Rubber
 Sidemarker: w/
 Tail light: w/
 No./LEDs: 2x3
 RH/LH: RH/LH
 Approvals: ADR/SAE
 E-approval: Yes

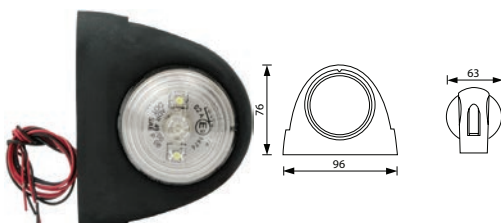
171617 LED Tail-Position Lamp

Voltage: 9-36

 Dim.: 96x76x63 mm
 OD: 76 mm
 Dist. mount. holes:
 78 mm

 Type: LED
 Colour/glass: Red/white
 Material: Synthetic rubber
 Sidemarker: w/
 Tail light: w/
 No./LEDs: 2x3
 RH/LH: RH/LH
 Approvals: ADR/SAE
 E-approval: Yes

171730 LED Tail/Position/Side Marker
w/ 128 mm rubber arm.

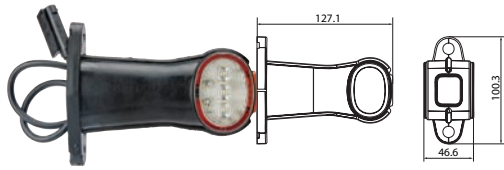

Voltage: 12/24

Dim.: 127.1x100.3 mm
Cable length: 500 mm
Dist. mount. holes: 78 mm

Type: LED
Mount.: 2 screws
Sidemarker: w/
Sidemarker lamp: w/
Tail light: w/
No./LEDs: 7
RH/LH: RH/LH
Tightness norm: IP 67
E-approval: Yes

171731 LED Tail/Position/Side Marker
w/ 145 mm rubber arm.

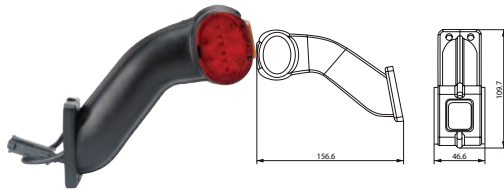

Voltage: 12/24

Dim.: 142.2x130.5x40.5 mm
Cable length: 450 mm
Dist. mount. holes: 52 mm

Type: LED
Colour: Black
Material: Rubber
Mount.: 4 holes
Sidemarker: w/
Sidemarker lamp: w/
Tail light: w/
No./LEDs: 9
RH/LH: RH
E-approval: Yes

171732 LED Tail/Position/Side Marker

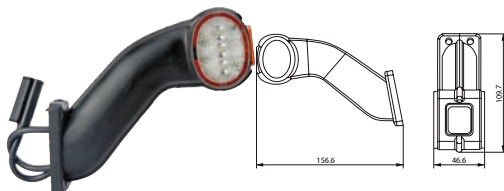

Voltage: 12/24

Dim.: 142.2x130.5x40.5 mm
Cable length: 450 mm
Dist. mount. holes: 52 mm

Type: LED
Colour: Black
Material: Rubber
Mount.: 4 holes
Sidemarker: w/
Sidemarker lamp: w/
Tail light: w/
No./LEDs: 9
RH/LH: LH
E-approval: Yes

171733 LED Tail/Position/Side Marker

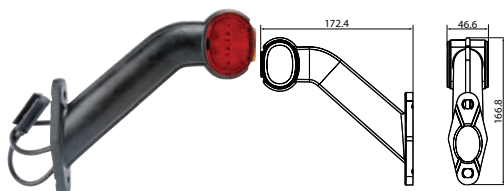

Voltage: 12/24

Dim.: 172.4x166.8x46.6 mm
Cable length: 500 mm
Dist. mount. holes: 78 mm

Type: LED
Mount.: 2 screws
Sidemarker: w/
Sidemarker lamp: w/
Tail light: w/
No./LEDs: 7
RH/LH: RH

171734 LED Tail/Position/Side Marker

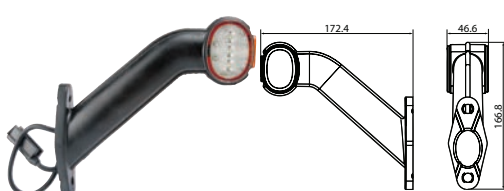

Voltage: 12/24

Dim.: 172.4x166.8x46.6 mm
Cable length: 500 mm
Dist. mount. holes: 78 mm

Type: LED
Mount.: 2 screws
Sidemarker: w/
Sidemarker lamp: w/
Tail light: w/
No./LEDs: 7
RH/LH: LH

171958 LED Tail-Position Lamp

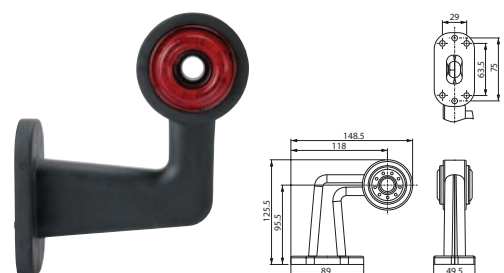

Voltage: 12-24

Dim.: 148.5x125.5x89 mm
Cable length: 300 mm
Dist. mount. holes: 63.5/75/29 mm

Type: LED
Colour: Black
Colour/glass: Red/white
Material: Rubber
Material/dome: Shockproof plastic
Shape: Round
Mount.: 6 screws
Sidemarker: w/
Tail light: w/
RH/LH: RH
Tightness norm: IP 68
E-approval: Yes

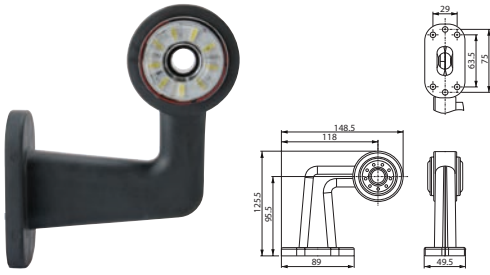
171959 LED Tail-Position Lamp

Voltage: 12-24

Dim.:
 148.5x125.5x89 mm
Cable length: 300 mm
Dist. mount. holes:
 63.5/75/29 mm

Type: LED
Colour: Black
Colour/glass: Red/white
Material: Rubber
Material/dome: Shockproof plastic
Shape: Round
Mount.: 6 screws
Sidemarker: w/
Tail light: w/
RH/LH: LH
Tightness norm: IP 68
E-approval: Yes

171960 LED Tail-Position Lamp

Voltage: 12-24

Dim.: 97x78x49 mm
Cable length: 300 mm
Dist. mount. holes:
 75/63.5/29 mm

Type: LED
Colour: Black
Colour/glass: Red/white
Material: Rubber
Material/dome: Shockproof plastic
Shape: Round
Mount.: 6 screws
Sidemarker: w/
Tail light: w/
RH/LH: RH/LH
Tightness norm: IP 68
E-approval: Yes

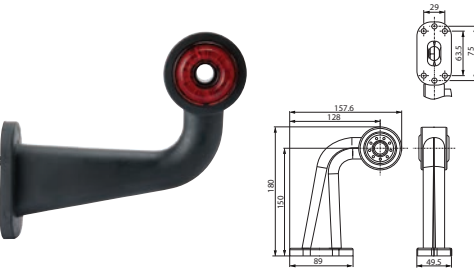
171961 LED Tail-Position Lamp

Voltage: 12-24

Dim.: 180x157.6x89 mm
Cable length: 300 mm
Dist. mount. holes:
 75/63.5/29 mm

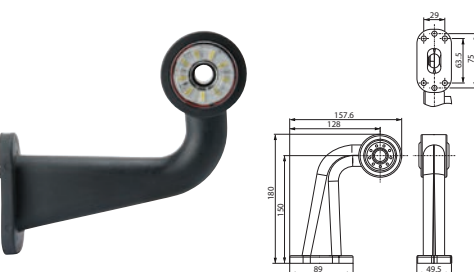
Type: LED
Colour: Black
Colour/glass: Red/white
Material: Rubber
Material/dome: Shockproof plastic
Shape: Round
Mount.: 6 screws
Sidemarker: w/
Tail light: w/
RH/LH: RH
Tightness norm: IP 68
E-approval: Yes

171962 LED Tail-Position Lamp

Voltage: 12-24

Dim.: 180x157.6x89 mm
Cable length: 300 mm
Dist. mount. holes:
 75/63.5/29 mm

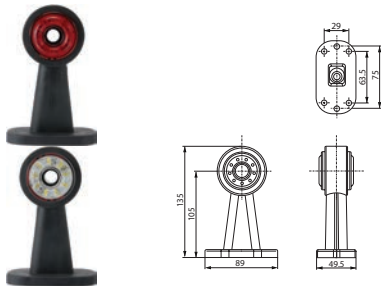
Type: LED
Colour: Black
Colour/glass: Red/white
Material: Rubber
Material/dome: Shockproof plastic
Shape: Round
Mount.: 6 screws
Sidemarker: w/
Tail light: w/
RH/LH: LH
Tightness norm: IP 68
E-approval: Yes

171963 LED Tail-Position Lamp

Voltage: 12-24

Dim.: 135x89x49.5 mm
Cable length: 300 mm
Dist. mount. holes:
 75/63.5/29 mm

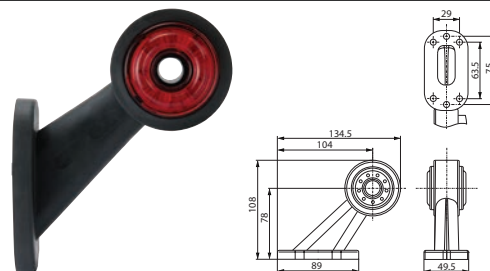
Type: LED
Colour: Black
Colour/glass: Red/white
Material: Rubber
Material/dome: Shockproof plastic
Shape: Round
Mount.: 6 screws
Sidemarker: w/
Tail light: w/
RH/LH: RH/LH
Tightness norm: IP 68
E-approval: Yes

171964 LED Tail-Position Lamp

Voltage: 12-24

Dim.: 134.5x108x89 mm
Cable length: 300 mm
Dist. mount. holes:
 75/63.5/29 mm

Type: LED
Colour: Black
Colour/glass: Red/white
Material: Rubber
Material/dome: Shockproof plastic
Shape: Round
Mount.: 6 screws
Sidemarker: w/
Tail light: w/
RH/LH: RH
Tightness norm: IP 68
E-approval: Yes

EL. SPECIFICATIONS	DIMENSIONS	ADDITIONAL SPECIFICATIONS
<p>171965 LED Tail-Position Lamp</p>	<p>Voltage: 12-24 Dim.: 134.5x108x89 mm Cable length: 300 mm Dist. mount. holes: 75/63.5/29 mm</p>	<p>Type: LED Colour: Black Colour/glass: Red/white Material: Rubber Material/dome: Shockproof plastic Shape: Round Mount.: 6 screws Sidemarker: w/ Tail light: w/ RH/LH: LH Tightness norm: IP 68 E-approval: Yes</p>
<p>171966 LED Tail/Position/Side Marker</p>	<p>Voltage: 12-24 Dim.: 187x165x37 mm Cable length: 300 mm Dist. mount. holes: 79 mm</p>	<p>Type: LED Colour: Black Colour/glass: Transparent Material: Rubber Material/dome: Shockproof plastic Mount.: 2 screws Sidemarker: w/ Sidemarker lamp: w/ Tail light: w/ RH/LH: RH Tightness norm: IP 68 E-approval: Yes</p>
<p>171967 LED Tail/Position/Side Marker</p>	<p>Voltage: 12-24 Dim.: 187x165x37 mm Cable length: 300 mm Dist. mount. holes: 79 mm</p>	<p>Type: LED Colour: Black Colour/glass: Transparent Material: Rubber Material/dome: Shockproof plastic Mount.: 2 screws Sidemarker: w/ Sidemarker lamp: w/ Tail light: w/ RH/LH: LH Tightness norm: IP 68 E-approval: Yes</p>
<p>171968 LED Tail/Position/Side Marker</p>	<p>Voltage: 12-24 Dim.: 135x114x37 mm Cable length: 300 mm Dist. mount. holes: 79 mm</p>	<p>Type: LED Colour: Black Colour/glass: Transparent Material: Rubber Material/dome: Shockproof plastic Mount.: 2 screws Sidemarker: w/ Sidemarker lamp: w/ Tail light: w/ RH/LH: RH Tightness norm: IP 68 E-approval: Yes</p>
<p>171969 LED Tail/Position/Side Marker</p>	<p>Voltage: 12-24 Dim.: 135x114x37 mm Cable length: 300 mm Dist. mount. holes: 79 mm</p>	<p>Type: LED Colour: Black Colour/glass: Transparent Material: Rubber Material/dome: Shockproof plastic Mount.: 2 screws Sidemarker: w/ Sidemarker lamp: w/ Tail light: w/ RH/LH: LH Tightness norm: IP 68 E-approval: Yes</p>
<p>171970 LED Tail/Position/Side Marker</p>	<p>Voltage: 12-24 Dim.: 103x84x33 mm Cable length: 300 mm Dist. mount. holes: 79 mm</p>	<p>Type: LED Colour: Black Colour/glass: Transparent Material: Rubber Material/dome: Shockproof plastic Mount.: 2 screws Sidemarker: w/ Sidemarker lamp: w/ Tail light: w/ RH/LH: RH/LH Tightness norm: IP 68 E-approval: Yes</p>

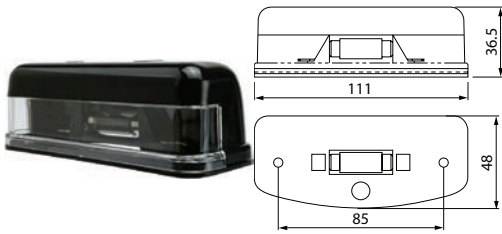
NUMBERPLATE LAMPS CONVENTIONAL
170002 Numberplate Lamp

 Servicing: Universal - Visit www.hc-cargo.com for further information

Voltage: 12/24
Watt: 5

Dim.: 111x36.5x48 mm

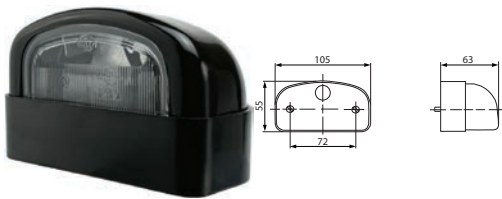
Socket type: S8.5
Colour: Black
Shape: Rectangular
Approvals: CE

170936 Numberplate Lamp

Voltage: 12
Watt: 5

Dim.: 105x55x63 mm
Dist. mount. holes: 72 mm

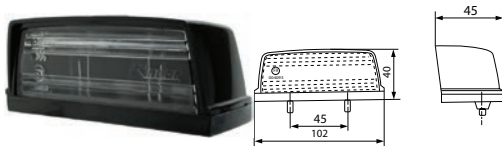
Type: Illumination of numberplate
Socket type: S8.5
Colour: Black
Material: Shockproof plastic
Fixing screw: 2
Numberplate light: w/
E-approval: Yes

171045 Numberplate Lamp

Voltage: 12/24
Watt: 5

Dim.: 102x40x45 mm
Dist. mount. holes: 45 mm

Type: Illumination of numberplate
Socket type: S8.5
Colour: Black
Material: Shockproof plastic
Shape: Rectangular
Fixing screw: 2
E-approval: Yes

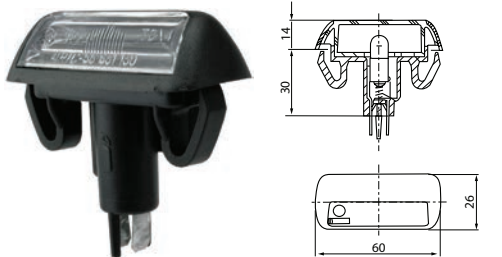
171164 Numberplate Lamp

 Servicing: Ford, Universal - Visit www.hc-cargo.com for further information

Voltage: 12
Watt: 5

Dim.: 60x26 mm

Type: Illumination of numberplate
Socket type: T10
E-approval: Yes

171166 Numberplate Lamp

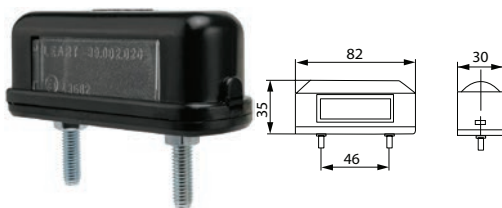
Universal.

Voltage: 12/24
Watt: 5

Dim.: 82x35x30 mm
Dist. mount. holes: 46 mm

Type: Illumination of numberplate
Socket type: S8.5
Colour: Black
Fixing screw: 2
Numberplate light: w/
E-approval: Yes

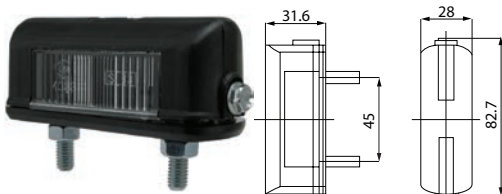
171224 Numberplate Lamp

Voltage: 12/24
Watt: 5

Dim.: 82.7x28x31.6 mm
Dist. mount. holes: 45 mm

Type: Illumination of numberplate
Socket type: S8.5
Colour: Black
Material: Shockproof plastic
Shape: Rectangular
Fixing screw: 2
E-approval: Yes

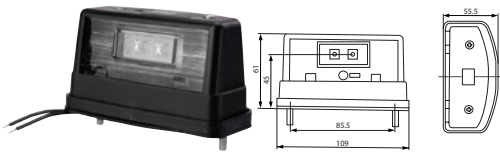
	EL. SPECIFICATIONS	DIMENSIONS	ADDITIONAL SPECIFICATIONS
171225 Numberplate Lamp			
	Voltage: 12/24 Watt: 10	Dim.: 142x67x55 mm Dist. mount. holes: 72 mm	Type: Illumination of numberplate Socket type: BA15S Material: Shockproof plastic Fixing screw: 2 E-approval: Yes
171345 Numberplate Lamp			
	Bulb incl.: No Watt: 5	Dim.: 100x58.1x69.7 mm Dist. mount. holes: 58.5 mm	Type: Illumination of numberplate Socket type: S8.5 Colour: Black Material: Plastic Fixing screw: 2 E-approval: Yes
171823 Numberplate Lamp			
	Bulb incl.: No Watt: 5	Dim.: 100x58.5x55.8 mm Dist. mount. holes: 72 mm	Type: Illumination of numberplate Socket type: S8.5 Colour: Black Colour/glass: Red Material: Plastic Fixing screw: 2 Numberplate light: w/ E-approval: Yes
NUMBERPLATE LAMPS LED			
171622 LED Numberplate Lamp			
	Voltage: 24	Dim.: 102x56x53 mm Dist. mount. holes: 72 mm	Type: LED Colour: Black Colour/glass: Transparent Numberplate light: w/ No./LEDs: 4 E-approval: Yes
171624 LED Numberplate Lamp			
	Voltage: 24	Dim.: 102x56x53 mm Dist. mount. holes: 73 mm	Type: LED Colour: Black Colour/glass: Red Shape: Rectangular Numberplate light: w/ LEDs: w/ E-approval: Yes
171709 LED Numberplate Lamp			
	Voltage: 12/24	Dim.: 109x61x55.5 mm Dist. mount. holes: 85.5 mm	Type: LED Socket type: LED Colour: Red Material: Shockproof plastic Fixing screw: 2 Numberplate light: w/ E-approval: Yes

171714 LED Numberplate Lamp

Voltage: 12/24

Dim.: 109x61x55.5 mm
Dist. mount. holes: 85.5 mm

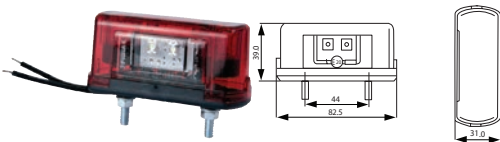
Type: LED
Socket type: LED
Colour: Black
Material: Shockproof plastic
Numberplate light: w/

171715 LED Numberplate Lamp

Voltage: 12/24

Dim.: 82.5x39x31 mm
Dist. mount. holes: 44 mm

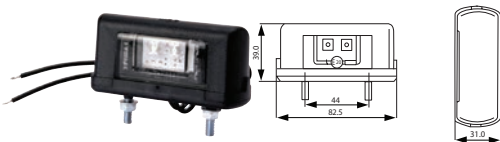
Type: LED
Socket type: LED
Colour/glass: Red
Material: Shockproof plastic
Fixing screw: 2
Numberplate light: w/
E-approval: Yes

171716 LED Numberplate Lamp

Voltage: 12/24

Dim.: 82.5x39x31 mm
Dist. mount. holes: 44 mm

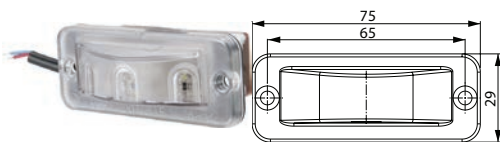
Type: LED
Socket type: LED
Colour: Black
Fixing screw: 2
Numberplate light: w/
E-approval: Yes

171737 LED Numberplate Lamp

Voltage: 12

Dim.: 75x29x34 mm
Cable length: 300 mm
Dist. mount. holes: 65 mm

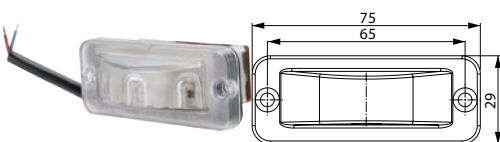
Type: LED
Mount.: 2 screws
Numberplate light: w/
No./LEDs: 3
E-approval: Yes

171738 LED Numberplate Lamp

Voltage: 24

Dim.: 75x29x34 mm
Cable length: 300 mm
Dist. mount. holes: 65 mm

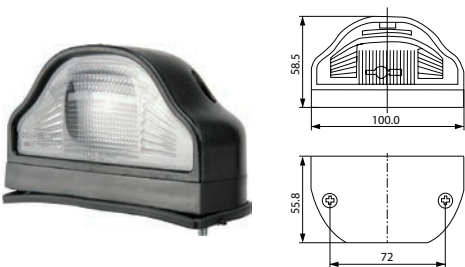
Type: LED
Mount.: 2 screws
Numberplate light: w/
No./LEDs: 3

171824 LED Numberplate Lamp

Voltage: 12/24
Watt: 0.5-1.1

Dim.: 100x58.5x55.8 mm
Cable length: 1000 mm
Dist. mount. holes: 72 mm

Type: LED
Colour: Black
Colour/glass: White
Material: Plastic
Fixing screw: 2
Numberplate light: w/
No./LEDs: 2
E-approval: Yes

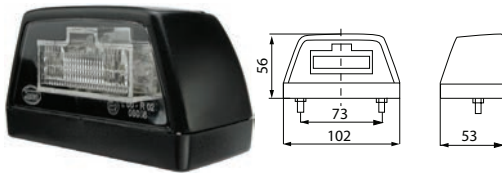
172002 LED Numberplate Lamp



Voltage: 12

Dim.: 102x56x53 mm
Dist. mount. holes:
73 mm

Type: LED
Colour: Black
Colour/glass: Transparent
Numberplate light: w/
No./LEDs: 4
E-approval: Yes

172009 LED Numberplate Lamp

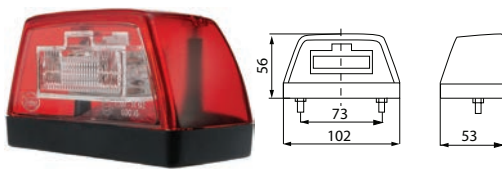

Voltage: 12

Dim.: 102x56x53 mm
Dist. mount. holes:
73 mm

Type: LED
Colour: Black
Colour/glass: Red
Shape: Rectangular
Numberplate light: w/
LEDs: w/
E-approval: Yes

TAIL-LIFT LAMPS CONVENTIONAL

170746 Tail Lift Lamp Set

Set of cables, connectors and mounting screws. Incl. 12/24 V relay.

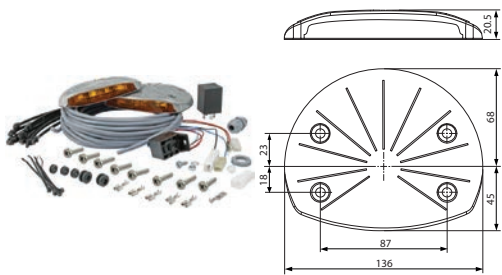

Bulb incl.: Yes
Voltage: 24

Dim.: 136x113x20.5 mm
Dist. mount. holes:
87 mm

Material: Cast aluminum
Approvals: GGVS/ADR

170748 Tail Lift Lamp

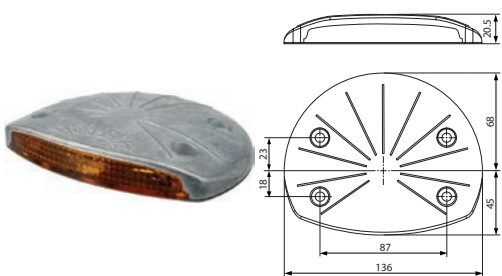

Bulb incl.: Yes
Voltage: 24

Dim.: 136x113x20.5 mm
Dist. mount. holes:
87 mm

Material: Cast aluminum
Approvals: GGVS/ADR
E-approval: Yes

TAIL-LIFT LAMPS LED

171621 LED Tail Lift Lamp

Dust and waterproof.

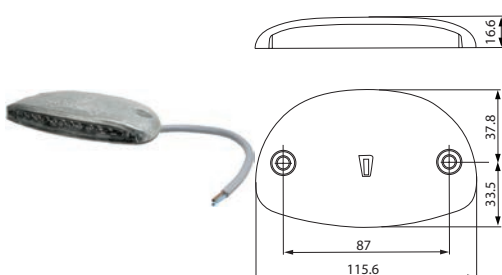

Voltage: 24

Dim.:
115x71.3x16.6 mm
Dist. mount. holes:
87 mm

Type: LED
Material: Alu/zinc
No./LEDs: 12
Approvals: GGVS/ADR

TRAILER LIGHTING SETS

170809 Trailer Lighting Set

Light construction. 7-pole plug.

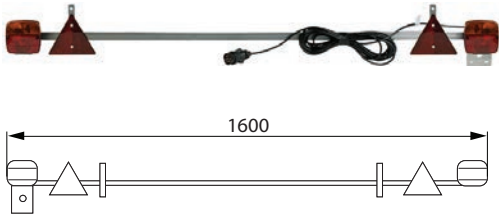

Bulb incl.: Yes
Voltage: 12

Dim.: 1600 mm
Cable length: 7500 mm

Material: Galvanised steel
No./lamps: 2
No./reflectors: 2
Flasher light: w/
Numberplate holder: w/
Stop light: w/

170828 Front/rear lighting set

7-pole plug. Tail-stop-flash lamp: HC-CARGO 170939. Flash-position lamp: HC-CARGO 170941. Magnet w/ metal bracket: HC-CARGO 170942.



Bulb incl.: Yes
Voltage: 12

Dim.: 107x100 mm
Cable length: 4500/7500 mm

Mount.: Magnetic
No./lamps: 2
Flasher light: w/
Sidemarker: w/
Tail light: w/
Stop light: w/

170829 Number Plate Holder

7-pole plug.

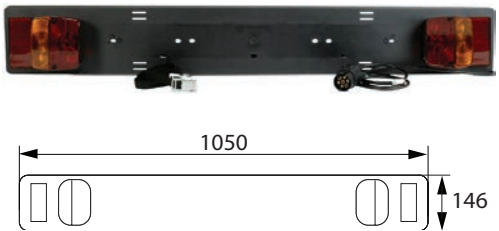

Bulb incl.: Yes
Voltage: 12

Dim.: 1050x146 mm
Cable length: 1500 mm

Reflector: w/
Numberplate holder: w/
Straps incl.: Yes

170835 Trailer Lighting Set

Light construction. 7-pole plug.

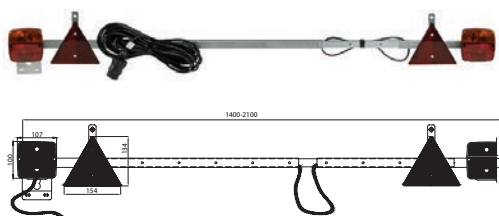

Bulb incl.: Yes
Voltage: 12

Dim.: 1400-2100 mm
Cable length: 12000 mm

Material: Galvanised steel
No./lamps: 2
No./reflectors: 2
Flasher light: w/
Numberplate holder: w/
Tail light: w/
Stop light: w/
Width/adjustable: w/

171049 Trailer Lighting Set

Extensible light construction. 7-pole plug.

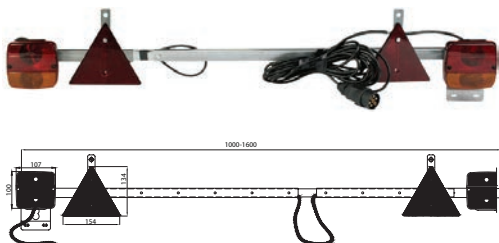

Bulb incl.: Yes
Voltage: 12

Dim.: 1000-1600 mm
Cable length: 7500 mm

Material: Galvanised steel
No./lamps: 2
No./reflectors: 2
Flasher light: w/
Numberplate holder: w/
Tail light: w/
Stop light: w/
Width/adjustable: w/

171818 Trailer lighting set

Lens: HC-CARGO 171833, 171834. Lamp: HC-CARGO 171870, 171871.

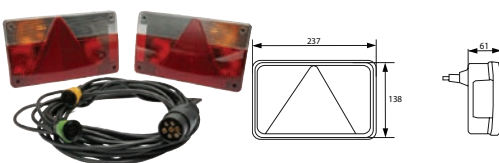

Bulb incl.: Yes
Voltage: 12

Dim.: 237x138x61 mm
Cable length: 2x5000 mm

Shape: Rectangular
No./lamps: 2
Flasher light: w/
Numberplate light: w/
Rear/fog lamp: w/
Tail light: w/
Stop light: w/
E-approval: Yes

171821 Trailer lighting set

Multi connector: HC-CARGO 171372, 171373. Lens: HC-CARGO 170833. Light: HC-CARGO 171822.

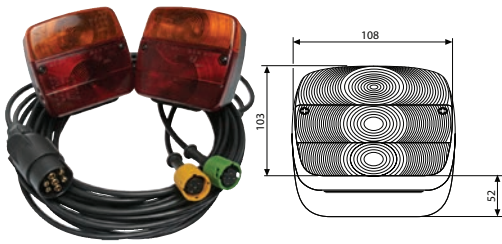

Bulb incl.: Yes
Voltage: 12

Dim.: 108x103x52 mm
Cable length:
2x5000 mm

Shape: Square
Flasher light: w/
Numberplate light: w/
Tail light: w/
Stop light: w/
E-approval: Yes

171872 Trailer lighting set

Lens: HC-CARGO 171833, 171834. Lamp: HC-CARGO 171870, 171871.

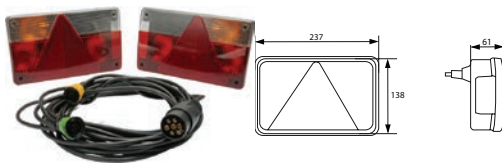

Bulb incl.: Yes
Voltage: 12

Dim.: 237x138x61 mm
Cable length:
2x7500 mm

Shape: Rectangular
No./lamps: 2
Flasher light: w/
Numberplate light: w/
Rear/fog lamp: w/
Tail light: w/
Stop light: w/
E-approval: Yes

171873 Trailer lighting set

Multi connector: HC-CARGO 171372, 171373. Lens: HC-CARGO 170833.

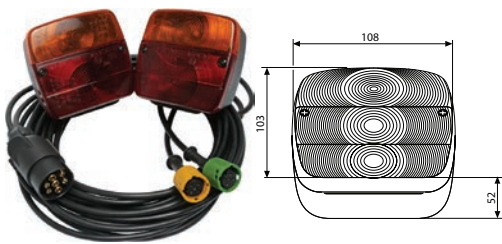

Bulb incl.: Yes
Voltage: 12

Dim.: 108x103x52 mm
Cable length:
2x7500 mm

Shape: Square
Flasher light: w/
Numberplate light: w/
Tail light: w/
Stop light: w/
E-approval: Yes

171935 Trailer Lighting Set

7-pole plug. Magnet w/ metalbracket: HC-CARGO 170942.

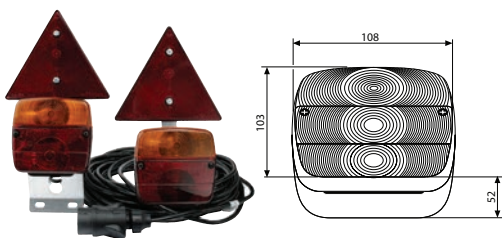

Bulb incl.: Yes
Voltage: 12

Dim.: 108x103x52 mm
Cable length:
4000/13000 mm

Mount.: Magnetic
No./lamps: 2
Flasher light: w/
Tail light: w/
Stop light: w/

SPARE PARTS

170833 Lens, Rear Lamp

Servicing: HC-CARGO 170939, 170940



Dim.: 108x103x52 mm

Material: Shockproof plastic
Flasher light: w/
Tail light: w/
Stop light: w/
RH/LH: RH/LH

170834 Lens, Rear Lamp

Servicing: HC-CARGO 170941



Dim.: 108x103x52 mm

Shape: Rectangular
Fixing screw: 2
Flasher light: w/
Sidemarker: w/

170939 Multi Function Lamp

Servicing: HC-CARGO 170809, 170818, 170828, 170829, 170835, 171049

Lens: HC-CARGO 170833.

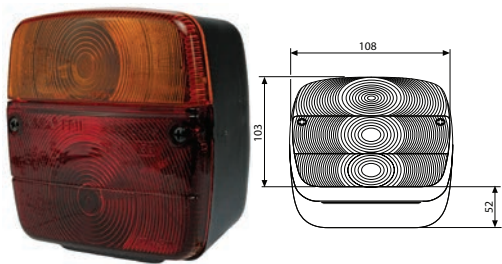
 Bulb incl.: No
 Watt: 21
 Watt 2: 21/5

 Dim.: 108x103x52 mm
 Dist. mount. holes:
 45/55 mm

 Socket type: BA15S
 Socket type 2: BAY15d
 Material: Shockproof plastic
 Fixing screw: 2
 Flasher light: w/
 Tail light: w/
 Stop light: w/
 RH/LH: RH/LH
 E-approval: Yes

170940 Multi Function Lamp

Servicing: HC-CARGO 170829

Lens: HC-CARGO 170833.

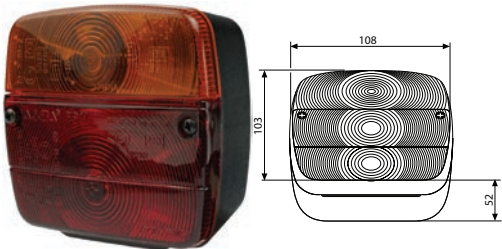
 Bulb incl.: No
 Watt: 21
 Watt 2: 21/5

 Dim.: 108x103x52 mm
 Dist. mount. holes:
 45/55 mm

 Socket type: BA15S
 Socket type 2: BAY15d
 Material: Shockproof plastic
 Fixing screw: 2
 Flasher light: w/
 Numberplate light: w/
 Tail light: w/
 Stop light: w/
 RH/LH: RH/LH
 E-approval: Yes

170941 Flasher/Position Lamp

Servicing: HC-CARGO 170828

Lens: HC-CARGO 170834.

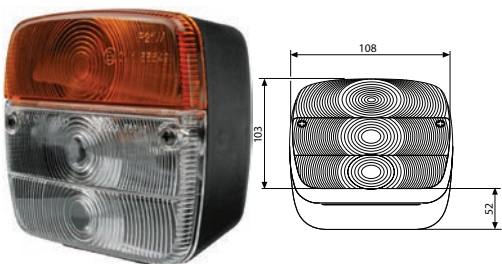
 Watt: 21
 Watt 2: 5

 Dim.: 108x103x52 mm
 Dist. mount. holes:
 45/55 mm

 Socket type: BA15S
 Socket type 2: S8.5
 Material: Shockproof plastic
 Shape: Rectangular
 Fixing screw: 2
 Flasher light: w/
 Sidemarker: w/
 RH/LH: RH/LH
 E-approval: Yes

170942 Magnet

Servicing: HC-CARGO 170818, 170828

For camera.



OD: 76 mm

171795 Rubber Protection

Servicing: HC-CARGO 170942



ID: 76 mm

Rubber: w/

171822 Multi Function Lamp

Servicing: HC-CARGO 171821

Multi connector: HC-CARGO 171372, 171373. Lens: HC-CARGO 170833.

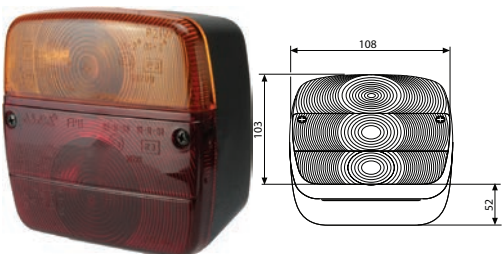
 Bulb incl.: Yes
 Watt: 21
 Watt 2: 21/5

 Dim.: 108x103x52 mm
 Dist. mount. holes:
 45/55 mm

 Socket type: BA15S
 Socket type 2: BAY15d
 Shape: Square
 Flasher light: w/
 Sidemarker: w/
 Stop light: w/
 E-approval: Yes

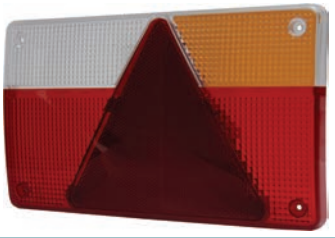
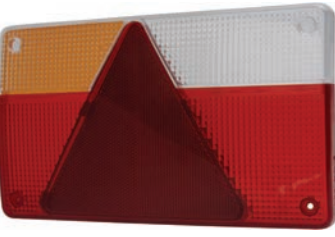
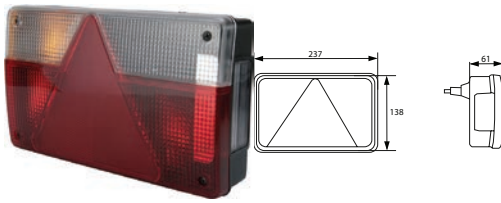
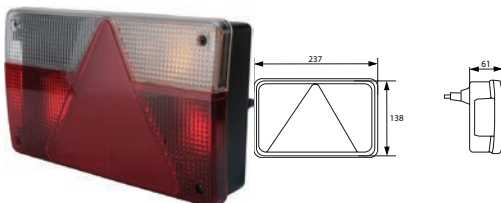
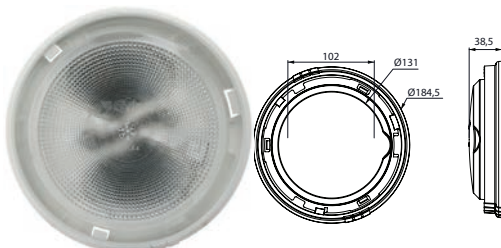
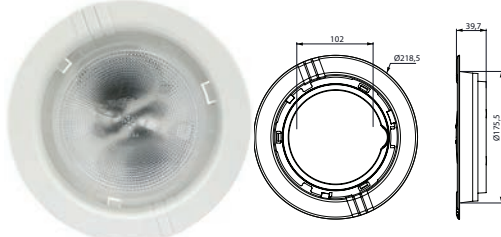
EL. SPECIFICATIONS	DIMENSIONS	ADDITIONAL SPECIFICATIONS
171833 Lens, Rear Lamp Servicing: HC-CARGO 171818, 171871, 171872		
	Dim.: 237x138x19 mm	Material: Shockproof plastic Shape: Rectangular Flasher light: w/ Numberplate light: w/ Rear/fog lamp: w/ Sidemarker: w/ Stop light: w/ RH/LH: RH E-approval: Yes
171834 Lens, Rear Lamp Servicing: HC-CARGO 171818, 171870, 171872		
	Dim.: 237x138x19 mm	Material: Shockproof plastic Shape: Rectangular Flasher light: w/ Numberplate light: w/ Rear/fog lamp: w/ Sidemarker: w/ Stop light: w/ RH/LH: LH E-approval: Yes
171870 Multi Function Lamp Servicing: HC-CARGO 171818, 171872		
<i>Multi connector: HC-CARGO 171372, 171373. Lens: HC-CARGO 171834. Right: HC-CARGO 171871.</i>		
	Bulb incl.: Yes Voltage: 12 Dim.: 237x138x61 mm	Shape: Rectangular Flasher light: w/ Numberplate light: w/ Rear/fog lamp: w/ Sidemarker: w/ Stop light: w/ RH/LH: LH E-approval: Yes
171871 Multi Function Lamp Servicing: HC-CARGO 171818, 171872		
<i>Multi Connector: HC-CARGO 171372, 171373. Lens: HC-CARGO 171833. Left: HC-CARGO 171872.</i>		
	Bulb incl.: Yes Voltage: 12 Dim.: 237x138x61 mm	Shape: Rectangular Flasher light: w/ Numberplate light: w/ Rear/fog lamp: w/ Sidemarker: w/ Stop light: w/ RH/LH: RH E-approval: Yes
<h2 style="text-align: center;">INTERIOR LAMPS CONVENTIONAL</h2>		
171356 Interior Lamp		
	Bulb incl.: No Watt: 25 Dim.: 184.5x38.5 mm Dist. mount. holes: 138 mm	Socket type: BA15S Material: Plastic Shape: Circular
171428 Interior Lamp		
<i>For build-in. Depth: 35 mm.</i>		
	Bulb incl.: No Watt: 25 Dim.: 218.5x39.7 mm Dist. mount. holes: 180 mm	Socket type: BA15S Material: Plastic Shape: Circular

INTERIOR LAMPS LED

171676 LED Interior Lamp

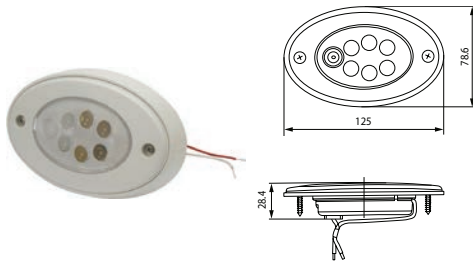

Voltage: 12/24
Watt: 0.7

Dim.: 125x78.6x28.4 mm
Cable length: 120 mm
Dist. mount. holes: 100 mm

Type: LED
Colour: White
Colour/glass: Frosted
Material: Shockproof plastic
Material/dome: PMMA
Shape: Oval
Switch: w/
No./LEDs: 6
Approvals: CE/UL

171677 LED Interior Lamp

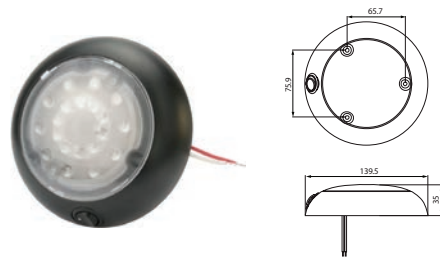

Voltage: 12/24
Watt: 1.5

Dim.: 139.5x35 mm
Cable length: 210 mm
Dist. mount. holes: 75 mm

Type: LED
Colour: Black
Colour/glass: Frosted
Material: Shockproof plastic
Material/dome: PMMA
Shape: Circular
Mount.: Plan installation
Switch: w/
No./LEDs: 20
Approvals: CE

171679 LED Interior Lamp

180° adjustable.

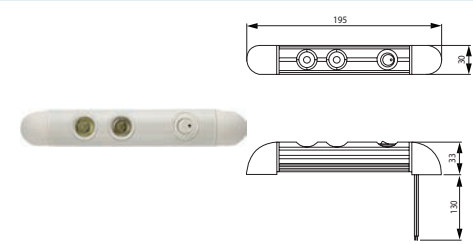

Voltage: 9-30
Watt: 3

Dim.: 195x30x33 mm
Cable length: 130 mm
Dist. mount. holes: 164 mm

Type: LED
Colour: White
Colour/glass: Transparent
Material: Alu/plastic
Material/dome: PMMA
Shape: Oblong
Switch: w/
No./LEDs: 2
Approvals: CE

171695 LED Interior Lamp

For flush mounting.

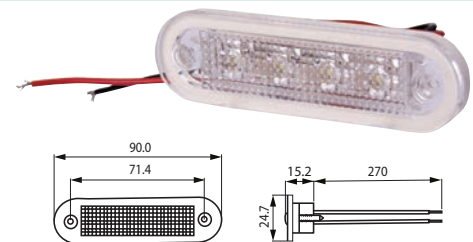

Voltage: 12/24

Dim.: 90x24.7 mm
Cable length: 270 mm
Dist. mount. holes: 71.4 mm

Type: LED
Colour: White
Colour/glass: Frosted
Material: Shockproof plastic
Material/dome: PMMA
Shape: Oval
Mount.: Plan installation
No./LEDs: 4
Tightness norm: IP 66
Approvals: CE

171696 LED Interior Lamp

For flush mounting.

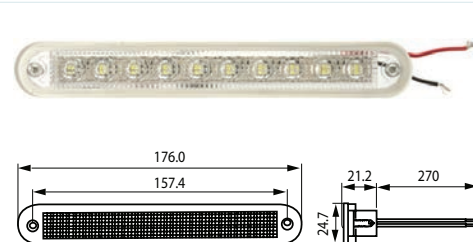

Voltage: 12/24
Watt: 0.8

Dim.: 176x24.7x21.2 mm
Cable length: 270 mm
Dist. mount. holes: 157.4 mm

Type: LED
Colour: White
Colour/glass: Frosted
Material: Shockproof plastic
Material/dome: PMMA
Shape: Oval
Mount.: Plan installation
No./LEDs: 10
Tightness norm: IP 66
Approvals: CE

171750 LED Interior Lamp



Voltage: 12/24

Dim.: 177x15.7 mm
Cable length: 500 mm
Dist. mount. holes: 140 mm

Type: LED
Colour: Chrome
Colour/glass: Frosted
Material: Shockproof plastic
Material/dome: PMMA
Shape: Round
Mount.: Plan installation
No./LEDs: 39
Tightness norm: IP 56

171767 LED Interior Lamp

Suited for flush mounting.

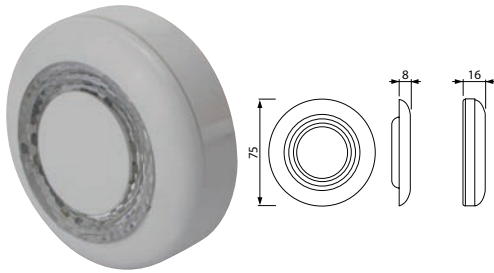

Voltage: 9-30
Watt: 0.8

Dim.: 75x16 mm
Cable length: 120 mm
Dist. mount. holes:
53 mm

Type: Interior lamp
Colour: White
Colour/glass: Transparent
Material: Shockproof plastic
Material/dome: PMMA
Shape: Round
Mount.: 3 screws
Switch: w/
No./LEDs: 1
Approvals: CE

171768 LED Interior Lamp

Suited for flush mounting.

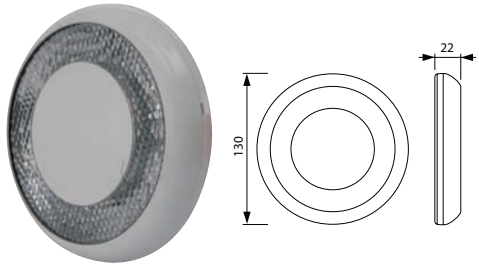

Voltage: 9-30
Watt: 2.8

Dim.: 130x22 mm
Cable length: 120 mm
Dist. mount. holes:
100 mm

Type: Interior lamp
Colour: White
Colour/glass: Frosted
Material: Shockproof plastic
Material/dome: PMMA
Shape: Round
Mount.: 3 screws
Switch: w/
No./LEDs: 1
Approvals: CE

171769 LED Reading lamp

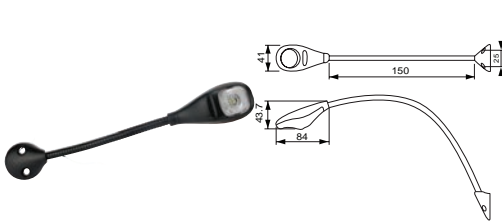

Voltage: 9-30
Watt: 1.8

Dim.: 150 mm
Cable length: 120 mm
Dist. mount. holes:
25 mm

Type: Interior lamp
Colour: Black
Colour/glass: Frosted
Material: ABS plastic/aluminium
Material/dome: Polycarbonate
Shape: w/ adjustable metal arm
Mount.: 2 screws
Switch: w/
No./LEDs: 1
Approvals: CE

171773 LED Interior Lamp HD

Servicing: Suitable for use in refrigeration vehicles - Visit www.hc-cargo.com for further information

Suited for flush mounting.

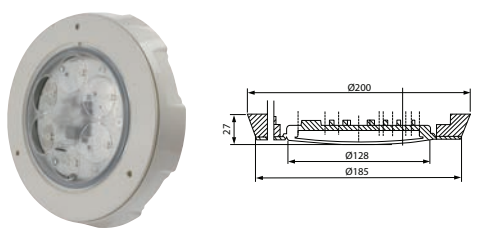

Voltage: 10-32
Watt: 8/9

Dim.: 200x27 mm
Dist. mount. holes:
137 mm

Type: Interior lamp
Colour: White
Colour/glass: Transparent
Material: Cast aluminum
Material/dome: Polycarbonate
Shape: Round
No./LEDs: 6
Tightness norm: IP 67
Approvals: EMC/ADR/GGVS

171776 LED Interior Lamp

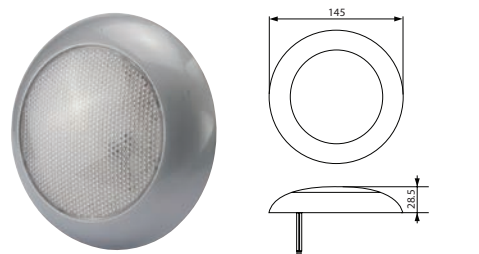

Voltage: 12/24

Dim.: 145x28.5 mm
Cable length: 220 mm
Dist. mount. holes:
123 mm

Type: LED
Colour: Silver
Colour/glass: Frosted
Material: Shockproof plastic
Material/dome: Shockproof plastic
Shape: Circular
Mount.: Plan installation
No./LEDs: 42
Tightness norm: IP 66
Approvals: CE







171825 LED Interior Lamp







Voltage: 24
Watt: 2.2

Dim.: 300x15.2x6 mm
Cable length: 400 mm

Type: LED
Colour: Grey
Colour/glass: Transparent
Material: Aluminium
Material/dome: Polycarbonate
Shape: Flat
Mount.: Plan installation
Bracket: Snap-on
Fixing screw: w/
No./LEDs: 12
Tightness norm: IP 65
Approvals: CE

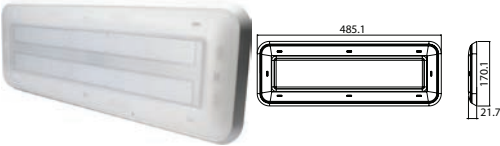
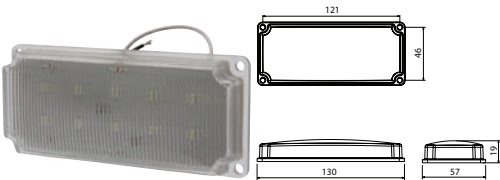
171826 LED Interior Lamp		EL. SPECIFICATIONS	DIMENSIONS	ADDITIONAL SPECIFICATIONS
	Voltage: 24 Watt: 4.3	Dim.: 600x15.2x6 mm Cable length: 400 mm	Type: LED Colour: Grey Colour/glass: Transparent Material: Aluminium Material/dome: Polycarbonate Shape: Flat Mount.: Plan installation Bracket: Snap-on Fixing screw: w/ No./LEDs: 24 Tightness norm: IP 65 Approvals: CE	
171827 LED Interior Lamp		Voltage: 24 Watt: 7.5	Dim.: 1000x15.2x6 mm Cable length: 400 mm	Type: LED Colour: Grey Colour/glass: Transparent Material: Aluminium Material/dome: Polycarbonate Shape: Flat Mount.: Plan installation Bracket: Snap-on Fixing screw: w/ No./LEDs: 42 Tightness norm: IP 65 Approvals: CE
	Voltage: 24 Watt: 10.8	Dim.: 1400x15.2x6 mm Cable length: 400 mm	Type: LED Colour: Grey Colour/glass: Transparent Material: Aluminium Material/dome: Polycarbonate Shape: Flat Mount.: Plan installation Bracket: Snap-on Fixing screw: w/ No./LEDs: 60 Tightness norm: IP 65 Approvals: CE	
171828 LED Interior Lamp		Voltage: 12 Watt: 2.2	Dim.: 300x15.2x6 mm Cable length: 400 mm	Type: LED Colour: Grey Colour/glass: Transparent Material: Aluminium Material/dome: Polycarbonate Shape: Flat Mount.: Plan installation Bracket: Snap-on Fixing screw: w/ No./LEDs: 12 Tightness norm: IP 65 Approvals: CE
	Voltage: 12 Watt: 4.3	Dim.: 600x15.2x6 mm Cable length: 400 mm	Type: LED Colour: Grey Colour/glass: Transparent Material: Aluminium Material/dome: Polycarbonate Shape: Flat Mount.: Plan installation Bracket: Snap-on Fixing screw: w/ No./LEDs: 24 Tightness norm: IP 65 Approvals: CE	
171829 LED Interior Lamp		Voltage: 12 Watt: 7.5	Dim.: 1000x15.2x6 mm Cable length: 400 mm	Type: LED Colour: Grey Colour/glass: Transparent Material: Aluminium Material/dome: Polycarbonate Shape: Flat Mount.: Plan installation Bracket: Snap-on Fixing screw: w/ No./LEDs: 42 Tightness norm: IP 65 Approvals: CE
	Voltage: 12 Watt: 4.3	Dim.: 600x15.2x6 mm Cable length: 400 mm	Type: LED Colour: Grey Colour/glass: Transparent Material: Aluminium Material/dome: Polycarbonate Shape: Flat Mount.: Plan installation Bracket: Snap-on Fixing screw: w/ No./LEDs: 24 Tightness norm: IP 65 Approvals: CE	
171830 LED Interior Lamp		Voltage: 12 Watt: 7.5	Dim.: 1000x15.2x6 mm Cable length: 400 mm	Type: LED Colour: Grey Colour/glass: Transparent Material: Aluminium Material/dome: Polycarbonate Shape: Flat Mount.: Plan installation Bracket: Snap-on Fixing screw: w/ No./LEDs: 42 Tightness norm: IP 65 Approvals: CE
	Voltage: 12 Watt: 7.5	Dim.: 1000x15.2x6 mm Cable length: 400 mm	Type: LED Colour: Grey Colour/glass: Transparent Material: Aluminium Material/dome: Polycarbonate Shape: Flat Mount.: Plan installation Bracket: Snap-on Fixing screw: w/ No./LEDs: 42 Tightness norm: IP 65 Approvals: CE	
171831 LED Interior Lamp		Voltage: 12 Watt: 7.5	Dim.: 1000x15.2x6 mm Cable length: 400 mm	Type: LED Colour: Grey Colour/glass: Transparent Material: Aluminium Material/dome: Polycarbonate Shape: Flat Mount.: Plan installation Bracket: Snap-on Fixing screw: w/ No./LEDs: 42 Tightness norm: IP 65 Approvals: CE
				

	EL. SPECIFICATIONS	DIMENSIONS	ADDITIONAL SPECIFICATIONS
171832 LED Interior Lamp		Voltage: 12 Watt: 10.8 Dim.: 1400x15.2x6 mm Cable length: 400 mm	Type: LED Colour: Grey Colour/glass: Transparent Material: Aluminium Material/dome: Polycarbonate Shape: Flat Mount.: Plan installation Bracket: Snap-on Fixing screw: w/ No./LEDs: 60 Tightness norm: IP 65 Approvals: CE
171863 LED Interior Lamp		Voltage: 12/24 Watt: 22 Dim.: 465x150x21.7 mm Cable length: 420 mm	Type: LED Colour: White Colour/glass: Frosted Material: Shockproof plastic Material/dome: PMMA Shape: Rectangular Mount.: Built-in No./LEDs: 12 Tightness norm: IP 67 Approvals: CE
171864 LED Interior Lamp		Voltage: 12/24 Watt: 22 Dim.: 485.1x170.1x21.7 mm Cable length: 420 mm	Type: LED Colour: White Colour/glass: Frosted Material: Shockproof plastic Material/dome: PMMA Shape: Rectangular Mount.: Plan installation No./LEDs: 12 Tightness norm: IP 67 Approvals: CE
171866 LED Interior Lamp		Voltage: 12/24 Dim.: 130x57x19 mm Cable length: 150 mm Dist. mount. holes: 46x121 mm	Type: LED Colour: Transparent Colour/glass: Frosted Material: Shockproof plastic Material/dome: PMMA Shape: Rectangular Mount.: Plan installation Fixing screw: 4 No./LEDs: 10 Tightness norm: IP 67 Approvals: CE
171874 LED Interior Lamp		Voltage: 10-33 Watt: 1.6-3.4 Dim.: 300x19x19 mm Cable length: 400 mm	Type: LED Colour: Grey Colour/glass: Transparent Material: Aluminium Material/dome: Polycarbonate Shape: Angled Mount.: Plan installation Bracket: Snap-on No./LEDs: 12 Tightness norm: IP 65 Approvals: CE
171875 LED Interior Lamp		Voltage: 10-30 Watt: 3.2-6.8 Dim.: 600x19x19 mm Cable length: 400 mm	Type: LED Colour: Grey Colour/glass: Transparent Material: Aluminium Material/dome: Polycarbonate Shape: Angled Mount.: Plan installation Bracket: Snap-on No./LEDs: 24 Tightness norm: IP 65 Approvals: CE

171876 LED Interior Lamp



Voltage: 10-30
Watt: 5.7-11.8

Dim.: 1000x19x19 mm
Cable length: 400 mm

Type: LED
Colour: Grey
Colour/glass: Transparent
Material: Aluminium
Material/dome: Polycarbonate
Shape: Angled
Mount.: Plan installation
Bracket: Snap-on
No./LEDs: 42
Tightness norm: IP 65
Approvals: CE

171877 LED Interior Lamp



Voltage: 10-30
Watt: 8.1-16.8

Dim.: 1400x19x19 mm
Cable length: 400 mm

Type: LED
Colour: Grey
Colour/glass: Transparent
Material: Aluminium
Material/dome: Polycarbonate
Shape: Angled
Mount.: Plan installation
Bracket: Snap-on
No./LEDs: 60
Tightness norm: IP 65
Approvals: CE

INTERIOR LAMPS FLOURESCENT

RESOLUX 720

170032 Interior Lamp

Tube fluorescent: HC-CARGO 171397.

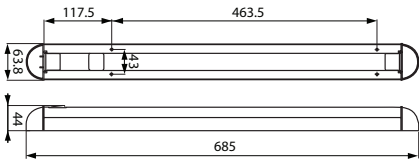

Voltage: 12
Watt: 13

Dim.: 685x63.8x44 mm
Dist. mount. holes:
463.5 mm

Colour: White
Material: Aluminium
Shape: Oblong
Switch: w/
Fixing screw: 2
Tightness norm: IP 40
Approvals: CE

170033 Interior Lamp

Tube fluorescent: HC-CARGO 171397.

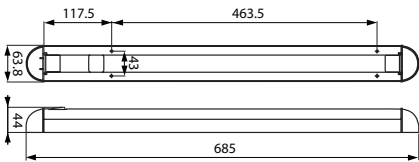

Voltage: 24
Watt: 13

Dim.: 685x63.8x44 mm
Dist. mount. holes:
590 mm

Colour: White
Material: ABS plastic/aluminium
Shape: Oblong
Switch: w/
Fixing screw: 2
Tightness norm: IP 40
Approvals: CE

RESOLUX 505

170035 Interior Lamp

Tube fluorescent: HC-CARGO 170664.

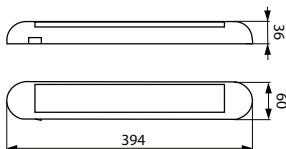

Voltage: 12
Watt: 8

Dim.: 394x60x36 mm
Dist. mount. holes:
350 mm

Colour: White
Material: ABS plastic
Shape: Oval
Switch: w/
Fixing screw: 2
Tightness norm: IP 40
Approvals: CE

170036 Interior Lamp

Tube fluorescent: HC-CARGO 170664.

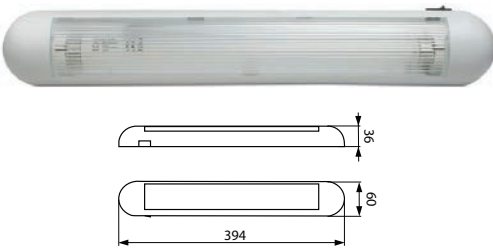

Voltage: 24
Watt: 8

Dim.: 394x60x36 mm
Dist. mount. holes:
350 mm

Colour: White
Material: ABS plastic
Shape: Oblong
Switch: w/
Fixing screw: 2
Tightness norm: IP 40
Approvals: CE

TWINLIGHTS

171392 Interior Lamp

w/ switch 0-1-2. Tube: HC-CARGO 170664.



Voltage: 12
Watt: 2x8

Dim.: 360x62x37 mm
Dist. mount. holes:
200 mm

Colour: White
Material: Plastic
Shape: Rectangular
Switch: w/
Fixing screw: 2

SLIM STYLING

171393 Interior Lamp

Tube fluorescent: HC-CARGO 170664.



Voltage: 12
Watt: 8

Dim.: 350x50x26 mm
Dist. mount. holes:
235 mm

Colour: White
Material: Plastic
Shape: Rectangular
Switch: w/
Fixing screw: 2

171396 Interior Lamp

Tube fluorescent: HC-CARGO 171397.



Voltage: 24
Watt: 13

Dim.: 580x50x26 mm
Dist. mount. holes:
465 mm

Colour: White
Material: Plastic
Shape: Rectangular
Switch: w/
Fixing screw: 2

SPARE PARTS

170664 Neon tube

Servicing: HC-CARGO 170035, 170036, 171393, 200181



Watt: 8

Length: 300 mm

171397 Neon tube

Servicing: HC-CARGO 170032, 170033, 171396



Watt: 13

Length: 530 mm

REFLECTORS

170142 Reflector

w/ 5 mm bolt.



OD: 60 mm

Colour: Red
Material: Plastic
Shape: Round
Approvals: I A approval
E-approval: Yes

170143 Reflector

w/ 5 mm bolt.



OD: 83 mm

Colour: Red
Material: Plastic
Shape: Round
Approvals: I A approval
E-approval: Yes

170144 Reflector



Dim.: 160x160x160 mm
Dist. mount. holes:
85 mm

Colour: Red
Material: Plastic
Shape: Triangle
Mount.: 2 screws
Approvals: III A approval
E-approval: Yes

170163 Reflector

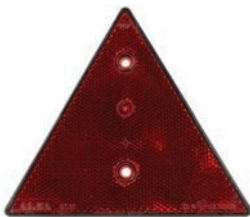

Dim.: 155x135 mm
Dist. mount. holes:
70 mm

Colour: Red
Material: Plastic
Shape: Triangle
Mount.: 2 holes
Approvals: III A approval
E-approval: Yes

170165 Reflector



OD: 60 mm
Hole size: 4 mm

Colour: Red
Material: Plastic
Shape: Round
Approvals: I A approval
E-approval: Yes

170169 Reflector



OD: 60 mm
Hole size: 4 mm

Colour: Orange
Material: Plastic
Shape: Round
Approvals: I A approval
E-approval: Yes

170170 Reflector



OD: 60 mm
Hole size: 4 mm

Colour: White
Material: Plastic
Shape: Round
Approvals: I A approval
E-approval: Yes

170208 Reflector
Only approved in DK.

Dim.: 50x200 mm

 Colour: Red
 Mount.: Self adhesive
 Approvals: JRU
 E-approval: No

170212 Reflector
Only approved in DK.



Dim.: 50x200 mm

 Colour: White
 Mount.: Self adhesive
 Approvals: JRU
 E-approval: No

170213 Reflector
Only approved in DK.

Dim.: 50x200 mm

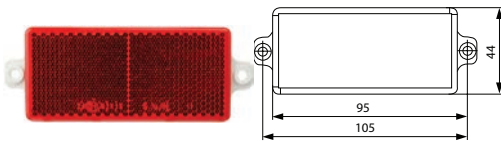
 Colour: Yellow
 Mount.: Self adhesive
 Approvals: JRU
 E-approval: No

170623 Reflector

 Dim.: 95x44 mm
 Dist. mount. holes:
 105 mm

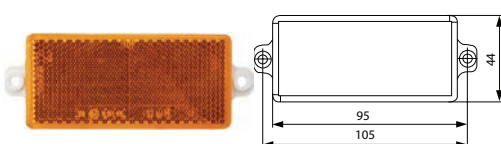
 Colour: Red
 Material: Plastic
 Shape: Rectangular
 Mount.: 2 holes
 Approvals: 1 A approval
 E-approval: Yes

170624 Reflector

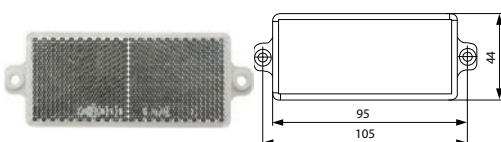
 Dim.: 95x44 mm
 Dist. mount. holes:
 105 mm

 Colour: Orange
 Material: Plastic
 Shape: Rectangular
 Mount.: 2 holes
 Approvals: 1 A approval
 E-approval: Yes

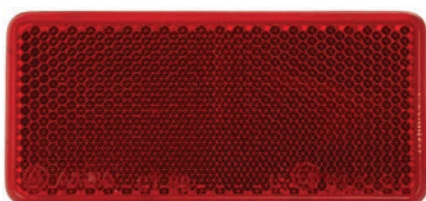

170625 Reflector

 Dim.: 95x44 mm
 Dist. mount. holes:
 105 mm



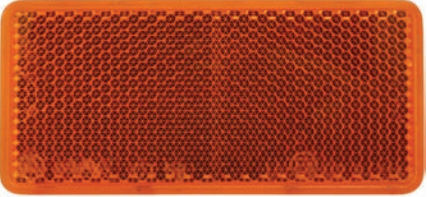
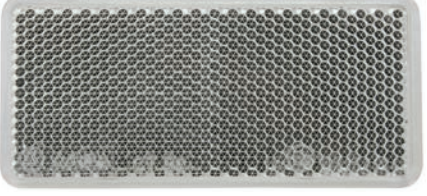
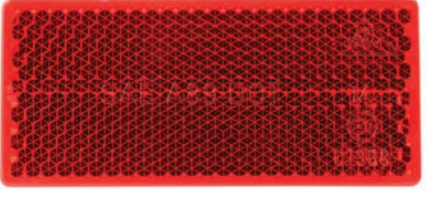
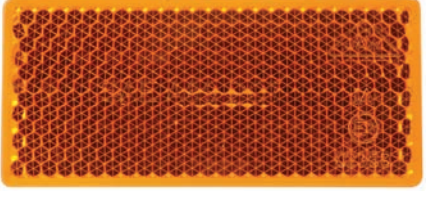
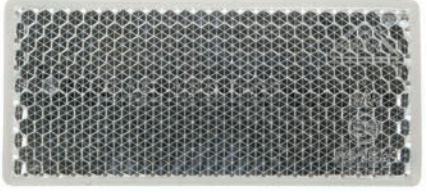

 Colour: White
 Material: Plastic
 Shape: Rectangular
 Mount.: 2 holes
 Approvals: 1 A approval
 E-approval: Yes

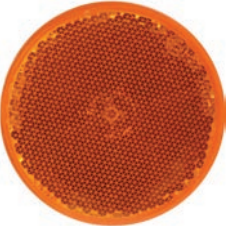
170626 Reflector

Dim.: 95x44 mm

 Colour: Red
 Material: Plastic
 Shape: Rectangular
 Mount.: Self adhesive
 Approvals: 1 A approval
 E-approval: Yes

EL. SPECIFICATIONS	DIMENSIONS	ADDITIONAL SPECIFICATIONS
<p>170627 Reflector</p> 	<p>Dim.: 95x44 mm</p>	<p>Colour: Orange Material: Plastic Shape: Rectangular Mount.: Self adhesive Approvals: I A approval E-approval: Yes</p>
<p>170628 Reflector</p> 	<p>Dim.: 95x44 mm</p>	<p>Colour: White Material: Plastic Shape: Rectangular Mount.: Self adhesive Approvals: I A approval E-approval: Yes</p>
<p>170629 Reflector</p> 	<p>Dim.: 71x35 mm</p>	<p>Colour: Red Material: Plastic Shape: Rectangular Mount.: Self adhesive Approvals: I A approval E-approval: Yes</p>
<p>170630 Reflector</p> 	<p>Dim.: 71x35 mm</p>	<p>Colour: Orange Material: Plastic Shape: Rectangular Mount.: Self adhesive Approvals: I A approval E-approval: Yes</p>
<p>170631 Reflector</p> 	<p>Dim.: 71x35 mm</p>	<p>Colour: White Material: Plastic Shape: Rectangular Mount.: Self adhesive Approvals: I A approval E-approval: Yes</p>
<p>170675 Reflector</p> 	<p>OD: 60 mm</p>	<p>Colour: Red Material: Plastic Shape: Round Mount.: Self adhesive Approvals: I A approval E-approval: Yes</p>
<p>170676 Reflector</p> 	<p>OD: 60 mm</p>	<p>Colour: Orange Material: Plastic Shape: Round Mount.: Self adhesive Approvals: I A approval E-approval: Yes</p>

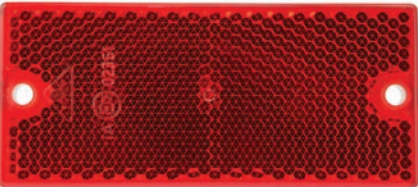
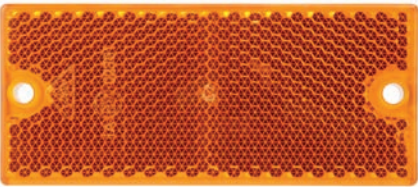
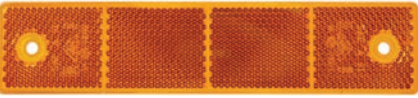
EL. SPECIFICATIONS	DIMENSIONS	ADDITIONAL SPECIFICATIONS
<p>170677 Reflector</p> 	<p>OD: 60 mm</p>	<p>Colour: White Material: Plastic Shape: Round Mount.: Self adhesive Approvals: 1 A approval E-approval: Yes</p>
<p>170729 Reflector</p> 	<p>OD: 83 mm Hole size: 4 mm</p>	<p>Colour: Red Material: Plastic Shape: Round Mount.: 1 hole Approvals: 1 A approval E-approval: Yes</p>
<p>170730 Reflector</p> 	<p>OD: 83 mm Hole size: 4 mm</p>	<p>Colour: White Material: Plastic Shape: Round Mount.: 1 hole Approvals: 1 A approval E-approval: Yes</p>
<p>171048 Reflector</p> 	<p>OD: 83 mm Hole size: 4 mm</p>	<p>Colour: Orange Material: Plastic Shape: Round Mount.: 1 hole Approvals: 1 A approval E-approval: Yes</p>
<p>171228 Reflector</p> 	<p>Dim.: 90x40 mm Dist. mount. holes: 79 mm</p>	<p>Colour: Red Material: Plastic Shape: Rectangular Mount.: 2 holes Approvals: 1 A approval E-approval: Yes</p>
<p>171230 Reflector</p> 	<p>Dim.: 90x40 mm Dist. mount. holes: 79 mm</p>	<p>Colour: Orange Material: Plastic Shape: Rectangular Mount.: 2 holes Approvals: 1 A approval E-approval: Yes</p>
<p>171233 Reflector</p> 	<p>Dim.: 180x40 mm Dist. mount. holes: 150 mm</p>	<p>Colour: Orange Material: Plastic Shape: Rectangular Mount.: 2 holes Approvals: 1 A approval E-approval: Yes</p>

ACCESSORIES
171536 Bracket

ID: 60 mm

No./mounting holes: 1 (0)

MISCELLANEOUS REAR MARKING
171883 Green Identifying Marker

Self-adhesive.

OD: 200 mm

 Colour: White/green
 Material: PVC Film
 Shape: Round
 Approvals: No Homogation required

171884 Green Identifying Marker

Self-adhesive.

OD: 200 mm

 Colour: White/green
 Material: PVC Film
 Shape: Round
 Approvals: No Homogation required

171885 Green Identifying Marker

Self-adhesive.

OD: 200 mm

 Colour: White/green
 Material: PVC Film
 Shape: Round
 Approvals: No Homogation required

171886 Green Identifying Marker

Self-adhesive.

OD: 200 mm

 Colour: White/green
 Material: PVC Film
 Shape: Round
 Approvals: No Homogation required

171887 Green Identifying Marker

Self-adhesive.

OD: 200 mm

 Colour: White/green
 Material: PVC Film
 Shape: Round
 Approvals: No Homogation required

171888 Green Identifying Marker

Self-adhesive.



OD: 200 mm

Colour: White/green
Material: PVC Film
Shape: Round
Approvals: No Homogation required

171889 Green Identifying Marker

Self-adhesive.



OD: 200 mm

Colour: White/green
Material: PVC Film
Shape: Round
Approvals: No Homogation required

SPEED LIMIT

171898 Max Speedsign 15 km

Self-adhesive. Class 2.



OD: 200 mm

Material: Film
Shape: Round

171899 Max Speedsign 40 km

Self-adhesive. Class 2.



OD: 200 mm

Material: Film
Shape: Round

171900 Max Speedsign 60 km

Self-adhesive. Class 2.



OD: 200 mm

Material: Film
Shape: Round

171901 Max Speedsign 70 km

Self-adhesive. Class 2.



OD: 200 mm

Material: Film
Shape: Round

171902 Max Speedsign 80 km

Self-adhesive. Class 2.

OD: 200 mm

 Material: Film
 Shape: Round

171903 Max Speedsign 100 km

Self-adhesive. Class 2.

OD: 200 mm

 Material: Film
 Shape: Round

REAR MARKING TRAILERS
170397 Reflector Board

Yellow: high intensive reflex. Class - A. Red: fluorescent.

Dim.: 1132x200 mm

 Colour: Red/yellow
 Material: Aluminium
 Shape: Rectangular
 Approvals: ECE70
 E-approval: Yes

170398 Reflector Board Set

Yellow: high intensive reflex. Class - A. Red: fluorescent. 2 pcs.

Dim.: 566x200 mm

 Colour: Red/yellow
 Material: Aluminium
 Shape: Rectangular
 Approvals: ECE70
 E-approval: Yes

170399 Reflector Board Set

Yellow: high intensive reflex. Class - A. Red: fluorescent. 4 pcs.

Dim.: 283x200 mm

 Colour: Red/yellow
 Material: Aluminium
 Shape: Rectangular
 Approvals: ECE70
 E-approval: Yes

170403 Reflector Foil Set

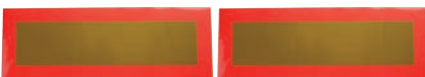
Yellow: high intensive reflex. Class - A. Red: fluorescent. 2 pcs.

Dim.: 566x200 mm

 Colour: Red/yellow
 Shape: Rectangular
 Mount.: Self adhesive
 Approvals: ECE70
 E-approval: Yes

170404 Reflector Foil Set

Yellow: high intensitive reflex. Class - A. Red: fluorescent. 4 pcs.

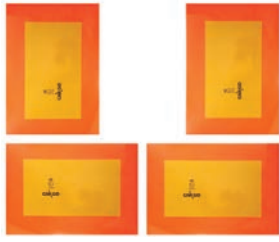

Dim.: 283x200 mm

Colour: Red/yellow
Shape: Rectangular
Mount.: Self adhesive
Approvals: ECE70
E-approval: Yes

171554 Reflector Tape 50 m

Safety marking for heavy vehicles and trailers. Mounting on rigid surface.



Dim.: 50000 mm

Colour: Yellow
Mount.: Self adhesive
Approvals: ECE104
E-approval: Yes

171555 Reflector Tape 50 m

Safety marking for heavy vehicles and trailers. Mounting on rigid surface.



Dim.: 50000 mm

Colour: White
Mount.: Self adhesive
Approvals: ECE104
E-approval: Yes

171556 Reflector Tape 50 m

Safety marking for heavy vehicles and trailers. Mounting on rigid surface.



Dim.: 50000 mm

Colour: Red
Mount.: Self adhesive
Approvals: ECE104
E-approval: Yes

171569 Reflector Board

Yellow: high intensitive reflex. Class 3. Red: fluorescent.



Dim.: 1132x197x1 mm

Colour: Red/yellow
Material: Aluminium
Shape: Rectangular
Approvals: ECE70-01
E-approval: Yes

171570 Reflector Board Set

Yellow: high intensitive reflex. Class 3. Red: fluorescent. 2 pcs.



Dim.: 566x197x0.8 mm

Colour: Red/yellow
Material: Aluminium
Shape: Rectangular
Approvals: ECE70-01
E-approval: Yes

171572 Reflector Foil Set

Yellow: high intensive reflex. Class 3. Red: fluorescent. 2 pcs.



Dim.: 566x197 mm

Colour: Red/yellow
Shape: Rectangular
Mount.: Self adhesive
Approvals: ECE70-01
E-approval: Yes

171575 Reflector Board Set

Yellow: high intensive reflex. Class 3. Red: fluorescent. 4 pcs.



Dim.: 283x197x0.8 mm

Colour: Red/yellow
Material: Aluminium
Shape: Rectangular
Approvals: ECE70-01
E-approval: Yes

REAR MARKING TRUCKS

170394 Reflector Board

Yellow: high intensive reflex. Class II. Red: fluorescent. 1 pcs.



Dim.: 1132x140x1.2 mm

Colour: Red/yellow
Material: Aluminium
Approvals: ECE70
E-approval: Yes

170395 Reflector Board Set

Yellow: high intensive reflex. Class II. Red: fluorescent. 2 pcs.



Dim.: 565x132x0.8 mm

Colour: Red/yellow
Material: Aluminium
Shape: Rectangular
Approvals: ECE70
E-approval: Yes

170396 Reflector Board Set

Yellow: high intensive reflex. Class II. Red: fluorescent. 4 pcs.

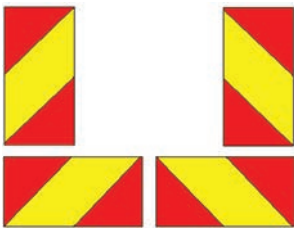

Dim.: 283x140x0.8 mm

Colour: Red/yellow
Material: Aluminium
Shape: Rectangular
Approvals: ECE70
E-approval: Yes

170401 Reflector Foil Set

Yellow: high intensive reflex. Class II. Red: fluorescent. 2 pcs.



Dim.: 566x140 mm

Colour: Red/yellow
Shape: Rectangular
Mount.: Self adhesive
Approvals: ECE70
E-approval: Yes

170402 Reflector Foil Set

Yellow: high intensive reflex. Class II. Red: fluorescent. 4 pcs.

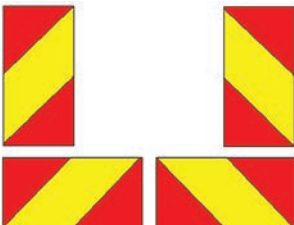

Dim.: 283x140 mm

Colour: Red/yellow
Shape: Rectangular
Mount.: Self adhesive
Approvals: ECE70
E-approval: Yes

171567 Reflector Board

Yellow: high intensitive reflex. Class 3. Red: fluorescent.



Dim.: 1132x132x1 mm

Colour: Red/yellow
Material: Aluminium
Shape: Rectangular
Approvals: ECE70-01
E-approval: Yes

171568 Reflector Board Set

Yellow: high intensitive reflex. Class 3. Red: fluorescent. 2 pcs.



Dim.: 565x132x0.8 mm

Colour: Red/yellow
Material: Aluminium
Shape: Rectangular
Approvals: ECE70-01
E-approval: Yes

171571 Reflector Foil Set

Yellow: high intensitive reflex. Class 3. Red: fluorescent. 2 pcs.



Dim.: 566x132 mm

Colour: Red/yellow
Shape: Rectangular
Mount.: Self adhesive
Approvals: ECE70-01
E-approval: Yes

171574 Reflector Board Set

Yellow: high intensitive reflex. Class - 3. Red: fluorescent. 4 pcs.



Dim.:
2830x1320x0.8 mm

Colour: Red/yellow
Material: Aluminium
Shape: Rectangular
Approvals: ECE70-01
E-approval: Yes

171878 Warning Liftflag Right

Servicing: HC-CARGO 171880, 171882

Right. Class 1.



Dim.: 410x250 mm

Colour: Red/white
Material: Canvas + film
Shape: Rectangular

171879 Warning Liftflag

Servicing: HC-CARGO 171881, 171882

Left. Class 1.



Dim.: 410x250 mm

Colour: Red/white
Material: Canvas + film
Shape: Rectangular

171880 Warning Liftflag w/ alu

w/ alu support. Right. Class 1.

Dim.: 410x250 mm

 Colour: Red/white
 Material: Canvas + film
 Shape: Rectangular

171881 Warning Liftflag w/ alu

w/ alu support. Left. Class 1.

Dim.: 410x250 mm

 Colour: Red/white
 Material: Canvas + film
 Shape: Rectangular

171882 Warning Liftflag w/ alu Kit

w/ alu support. Kit. Class 1.

Dim.: 410x250 mm

 Colour: Red/white
 Material: Canvas + film
 Shape: Rectangular

171890 Wide Load Marking

For Agriculture. Right. Class 1. DIN 11030.

Dim.: 423x423x0.8 mm

 Colour: Red/white
 Material: Zinc + film

171891 Wide Load Marking

For Agriculture. Right. Class 1. DIN 11030.

Dim.: 423x423x0.8 mm

 Colour: Red/white
 Material: Zinc + film
 Shape: Square

171892 Wide Load Marking Kit

For Agriculture. Kit. Class 1. DIN 11030.

Dim.: 564x282x0.8 mm

 Colour: Red/white
 Material: Zinc + film
 Shape: Rectangular

171893 Wide Load Marking

Class 1.



Dim.: 900x300x2 mm

Colour: Black/yellow/red
Material: Aluminium + film
Shape: Rectangular
Approvals: No Homogation required

171894 Wide Load Marking

Class 1.



Dim.: 565x200x2 mm

Colour: Black/yellow/red
Material: Aluminium + film
Shape: Rectangular
Approvals: No Homogation required

CONTAINER MARKING

171895 Skipmarking

Self-adhesive. Left. Class 2.



Dim.: 100x400 mm

Colour: White/red
Material: Film
Shape: Rectangular
Approvals: No Homogation required

171896 Skipmarking

Self-adhesive. Right. Class 2.



Dim.: 100x400 mm

Colour: White/red
Material: Film
Shape: Rectangular
Approvals: No Homogation required

171897 Skipmarking

Self-adhesive kit. Class 2.



Dim.: 200x400 mm

Colour: White/red
Material: Film
Shape: Rectangular
Approvals: No Homogation required

WARNING TRIANGLES

170171 Warning Triangle

Break down warning triangle. Supplied in plastic carrying box.



Shape: Triangle
E-approval: Yes

TRIANGLES

170390 Reflector Triangle

Red: high intensive foil. Class A. Red: fluorenscent foil. w/o bracket.



Dim.: 350-365 mm
Dist. mount. holes:
153 mm

Colour: Red
Material: Aluminium
Shape: Triangle
E-approval: Yes

170407 Reflector Foil

Red: high intensive reflex. Class A. Red: fluorescent.



Dim.: 409x358x308 mm

Colour: Red
Shape: Triangle
Mount.: Self adhesive
E-approval: Yes

170759 Reflector Triangle

Red: high intensive foil. Class A. Red: fluorenscent foil. w/o bracket.



Dim.: 428x375x310 mm
Dist. mount. holes:
153 mm
Hole size: 6 mm

Colour: Red
Material: Shock thermo plastic
Shape: Triangle
E-approval: Yes

ACCESSORIES

170391 Mounting Bracket

Servicing: HC-CARGO 170390, 170759

Male.



170392 Mounting Bracket

Servicing: HC-CARGO 170390, 170759

Female.



170393 Mounting Bracket Kit

Servicing: HC-CARGO 170390, 170759

w/ male and female brackets, bolts and nuts.



170797 Mounting Bracket

Servicing: HC-CARGO 170390, 170759

Angled.



HAZARD WARNING LIGHTS

170683 Hazard Warning Lamp

Servicing: Approved for vehicles carrying dangerous goods - Visit www.hc-cargo.com for further information

Battery: HC-CARGO 200741, 200768.

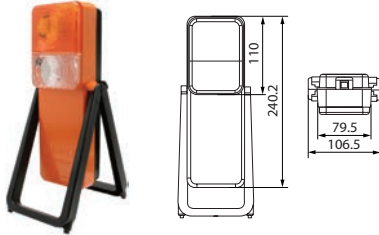

Dim.: 240.2x106.5 mm

Battery type: D
No./batteries: 5
Hazard flasher: w/
Approval: GGVS
E-approval: Yes

LED

171797 LED Hazard Warning Lamp

Battery: HC-CARGO 200739.



Dim.: 215x75x63 mm

Bulb type: LED
Battery type: AA
Material: ABS plastic
No./batteries: 4
Hazard flasher: w/
Drop proof: Yes
Approval: GGVS/ADR

PEN-/TORCH LIGHTS

TORCH LIGHT CONVENTIONAL

170353 High Powered Torch

Bulb: HC-CARGO 171280. Batteries: HC-CARGO 200741, 200768.



Dim.: 182x111 mm

Bulb type: Krypton
Battery type: D
No./batteries: 4
Approval: CE

TORCH LIGHT LED

171749 LED Torch Light

Battery: HC-CARGO 200738.



Watt: 1
Lumen: 65

Dim.: 37x120 mm

Bulb type: LED
Battery type: AAA
Material: Aluminium
No./batteries: 3
Clips: w/
Waterproof: Yes

171787 LED Torch Light

Battery: HC-CARGO 200740.



Watt: 2.2

Dim.: 217x52x52 mm

Bulb type: LED
Battery type: LR14
Material: Shockproof plastic
No./batteries: 3
Shoulder strap: w/
Drop proof: Yes
Waterproof: Yes

TORCH LIGHT LED/UV

171805 UV LED Torch light

Battery: HC-CARGO 200738.



Dim.: 126 mm

Bulb type: UV LED
 Battery type: AAA
 Material: Aluminium
 No./batteries: 3
 Waterproof: Yes
 Approval: CE

253489 UV Inspection Lamp

3 pcs. batteries and mirror included. Batteries: HC-CARGO 200858.



Bulb incl.: Yes

Type: LED
 Model: UV

253504 UV Lamp

Battery: HC-CARGO 200742.



Bulb incl.: Yes

Type: LED
 Colour: Red
 Material/dome: Shockproof plastic
 Model: UV

PEN-/TORCH LIGHTS LED

171704 LED Penlight

Button w/ easy touch for either signal or constant light. Optical lense intensive the light. At least 8 hours of burn time. Solder grip multiwire splices up to 10 wires of different sizes and can be combined w/ fluxed solder and heat shrinkable thermoplastic sleeve.



Dim.: 14.5x109 mm

Bulb type: LED
 Battery type: AAA
 Material: Aluminium
 No./batteries: 1
 Drop proof: Yes
 Waterproof: Yes
 Approval: CE

HAND LAMPS CONVENTIONAL

200181 Hand Lamp

Works at temperature below zero. All parts are replaceable.



Voltage: 230
 Watt: 8
 Lumen: 400

Length: 510 mm

Plug: w/
 Hi impact: Yes
 Tightness norm: IP 67
 Approvals: CE

200635 Hand Lamp

Four times more powerful than conventional hand lamps. Works at temperature below zero. All parts replaceable. Resistant to oil, petrol and chemicals.



Voltage: 230
 Watt: 11
 Lumen: 900

Length: 455 mm

Plug: w/
 Hi impact: Yes
 Tightness norm: IP 64
 Approvals: CE

200728 Hand Lamp

Works at temperature below zero. All parts are replaceable.



Voltage: 230
Watt: 9
Lumen: 400

Length: 390 mm

Plug: w/
Hi impact: Yes
Tightness norm: IP 65
Approvals: CE

200733 Hand Lamp



Voltage: 230
Watt: 8
Lumen: 300

Length: 450 mm

Plug: w/
Tightness norm: IP 20
Approvals: CE

200837 Hand Lamp



Voltage: 230
Watt: 11
Lumen: 900

Length: 450 mm

Hi impact: Yes
Tightness norm: IP 65
Approvals: CE

SPARE PARTS

170959 Fluorescent Tube

Servicing: HC-CARGO 200781

Socket PL-S 2P (G23).



Voltage: 230
Watt: 9/840
Lumen: 600

Length: 144 mm

Approvals: CE

170960 Fluorescent Tube

Socket PL-S 2P (G23).



Watt: 11/830
Lumen: 900

Length: 214 mm

Approvals: CE

171573 Neon tube

Socket PL-S 4P (2G7).



Watt: 11/830
Lumen: 900

Length: 214 mm

Approvals: CE

200659 Electronic Part

Servicing: HC-CARGO 200728, 200635

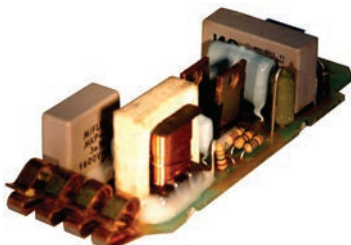

Watt: 230

Tightness norm: IP 65
Approvals: CE

ACCESSORIES

200684 Lamp Holder

For hand lamps.



Tightness norm: IP 67

HAND LAMPS LED

171999 LED Hand Lamp



Lumen: 300

Dim.: 270x42x51 mm

Bulb type: LED
 Battery type: Li-ion
 Magnet holder: Yes
 Lamp head: Yes
 Wall charger 230V: Yes
 Charger 12V: Yes
 Rechargeable: Yes
 Approval: CE

172000 LED Hand Lamp UK



Lumen: 300

Dim.: 270x42x51 mm

Bulb type: LED
 Battery type: Li-ion
 Magnet holder: Yes
 Lamp head: Yes
 Wall charger 230V: Yes
 Charger 12V: Yes
 Rechargeable: Yes
 Approval: CE

BULB HOLDERS

170135 Bulb Holder



Socket type: BAY15d

170136 Bulb Holder

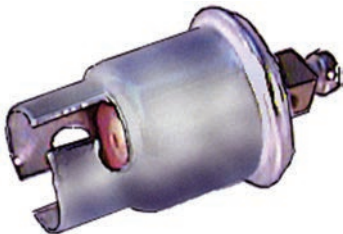

Socket type: BA9s

170137 Bulb Holder



Socket type: BA7s

	EL. SPECIFICATIONS	DIMENSIONS	ADDITIONAL SPECIFICATIONS
<p>170138 Bulb Holder</p> 			Socket type: BA15S
<p>170139 Bulb Holder 33-36 mm. Festoon type.</p> 			Socket type: S8.5
<p>170433 Bulb Holder Also for bulbs that fit socket P45t. Used w/ sealed beams.</p> 	Servicing: H4		Socket type: P43t
<p>170596 Bulb Holder</p> 			Socket type: BA15d
<p>170619 Bulb Holder Also for bulbs that fit socket P43t. Used w/ sealed beams.</p> 	Servicing: H4		Socket type: P45t
<p>170763 Bulb Holder</p> 	Servicing: VW Golf, Vento, Polo, Passat, Seat Ibiza, Toledo - Visit www.hc-cargo.com for further information		Socket type: T10
<p>170790 Bulb Holder 2x terminal connection.</p> 			Socket type: BA9s

170791 Bulb Holder

2x screw connection.

Socket type: BA15S

170799 Bulb Holder

Servicing: HC-CARGO 191938

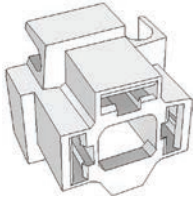
Also for bulbs that fit socket P45t. Used w/ sealed beams. Angled type.

Socket type: P43t

170827 Bulb Holder

2x terminal connection.

Socket type: T10

170964 Bulb Holder

Servicing: H4

Also for bulbs that fit socket P45. Used w/ sealed beams. w/ snap-lock action for cable connection.



Socket type: P43t+P45t

171426 Bulb Holder

w/ wire.

Socket type: HB3, H10, H12

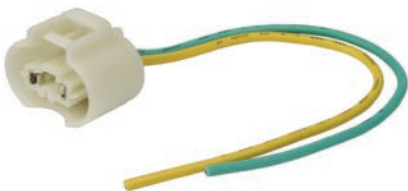
171427 Bulb Holder

w/ wire.

Socket type: HB4

171453 Bulb Holder

H7.

Socket type: PX26d

171783 Bulb Holder

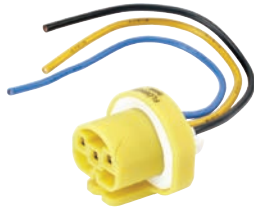

Socket type: HB1, HB5

171784 Bulb Holder



Socket type: H8, H9, H11

171924 Bulb Holder

H1/H3. 2 way.



Socket type: P14.5s, PK22s, PKY22s

171925 Bulb Holder

H1/H3. 1 way.



Socket type: P14.5s, PK22s, PKY22s

171954 Bulb Holder

H4.



Socket type: P43t

BULB HOLDER SETS

171281 Bulb Holder Set

Servicing: H4

Contains: 1 pcs. HC-CARGO 170619. 3 pcs. HC-CARGO 191200.



Socket type: P43t

171282 Bulb Holder Set

Servicing: H4

Contains: 1 pcs. HC-CARGO 170799. 3 pcs. HC-CARGO 191938.

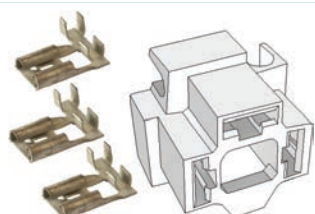

Socket type: P43t



Multi Function Lamps

Edition 2014/2015



HC-CARGO	Dimension	Servicing	Right / Left	Flasher light	Number Plates light	Rear fog lamp	Reflector	Reverse light	Side marker lamp	Stop light	Tail light	Connection	E-Approval	Replacing	Lens
171308	525 x 139 x 83	Mercedes Actros.	RH	✓	✓	✓	✓	✓	✓	✓	✓	M	✓	42940000, 42939000, 0015406370	HC-CARGO 171312
171311	525 x 139 x 83	Mercedes Actros.	LH	✓	✓	✓	✓	✓	✓	✓	✓	M	✓	42942000, 42941000, 0015406270	HC-CARGO 171521
171447	525 x 139 x 83	Mercedes Actros. SK	LH	✓	✓	✓	✓	✓	✓	✓	✓	G	✓	2VD007500-091	HC-CARGO 171521
171448	525 x 139 x 83	Mercedes Actros. SK	RH	✓	✓	✓	✓	✓	✓	✓	✓	B	✓		HC-CARGO 171312
171802	517 x 129.5 x 80.2	Scania.	RH	✓	✓	✓	✓	✓	✓	✓	✓		✓		HC-CARGO 171322
171803	517 x 129.5 x 80.2	Scania.	LH	✓	✓	✓	✓	✓	✓	✓	✓		✓		HC-CARGO 171322
170916	465 x 130 x 83	Scania, Universal.	LH	✓	✓	✓	✓	✓	✓	✓	✓	A		2vd007323-031, 21.197-021, 21.197-001, 170914, 168350, 168340, 1365963	HC-CARGO 170968
170917	465 x 130 x 83	Scania, Universal.	RH	✓	✓	✓	✓	✓	✓	✓	✓	A	✓	2vp007323-021, 2vd007323-041, 21.197-031, 21.197-011, 170915, 168360, 168270, 167600, 1365965, 1365964	HC-CARGO 170968
170922	465 x 130 x 83	MAN, Universal.	LH	✓	✓	✓	✓		✓	✓	✓	C	✓	2vd007323-131, 21.197-121, 168100	HC-CARGO 170968
170923	465 x 130 x 83	MAN, Universal	RH	✓	✓	✓	✓	✓	✓	✓	✓	C	✓	2vp007323-121, 2vd007323-141, 21.197-131, 21.197-111, 170921, 167700	HC-CARGO 170968
170998	465 x 130 x 83	Iveco.	RH/LH	✓		✓	✓		✓	✓	✓	D	✓	99463242, 44847000, 171298	HC-CARGO 171000
170999	465 x 130 x 83	Iveco.	RH/LH	✓	✓	✓	✓		✓	✓	✓	D	✓	99463244, 44848000	HC-CARGO 171000
171299	465 x 130 x 90	Mercedes Atego.	RH	✓	✓	✓	✓		✓	✓	✓	P	✓	42931000, 42632000, 0035445503, 0035445203	HC-CARGO 171307
171302	465 x 130 x 90	Mercedes Atego.	LH	✓	✓	✓	✓		✓	✓	✓	P	✓	42934000, 0035445603, 0035445303	HC-CARGO 171307
171303	465 x 130 x 90	Mercedes Sprinter.	RH	✓	✓	✓	✓		✓	✓	✓	K	✓	42935000, 42936000, 0035445403	HC-CARGO 171307
171306	465 x 130 x 90	Mercedes Sprinter.	LH	✓	✓	✓	✓		✓	✓	✓	K	✓	42938000, 42937000, 0025445503	HC-CARGO 171307
171806	428 x 140 x 87	Trucks, Universal	LH	✓		✓		✓	✓	✓	✓	M	✓		HC-CARGO 171810
171807	428 x 140 x 87	Trucks, Universal	RH	✓		✓		✓	✓	✓	✓	M	✓		HC-CARGO 171810
171808	428 x 140 x 87	Commercial trailers.	LH	✓		✓	✓	✓	✓	✓	✓	M	✓		HC-CARGO 171810
171809	428 x 140 x 87	Commercial trailers.	RH	✓		✓	✓	✓	✓	✓	✓	M	✓		HC-CARGO 171810
171441	421 x 147 x 75	Commercial Trailers.	LH	✓	✓		✓			✓	✓	K	✓		HC-CARGO 171446
171442	421 x 147 x 75	Commercial Trailers.	RH	✓	✓	✓	✓		✓	✓	✓	K	✓		HC-CARGO 171446
171443	421 x 147 x 75	Schwarz3Iler	LH	✓	✓	✓	✓		✓	✓	✓	I			HC-CARGO 171446
171444	421 x 147 x 75	Schwarz3Iler		✓	✓	✓	✓		✓	✓	✓	I			HC-CARGO 171446
170990	418 x 148 x 90	Commercial Trailers.	RH	✓	✓	✓	✓		✓	✓	✓	A	✓		HC-CARGO 170994
170991	418 x 148 x 90	Commercial Trailers.	LH	✓	✓	✓	✓		✓	✓	✓	A	✓		HC-CARGO 170995
170602	406 x 135 x 74	RVI Renault, Pegaso	LH	✓	✓	✓	✓	✓		✓	✓	A	✓	141500	HC-CARGO 170665
170603	406 x 135 x 74	RVI Renault, Pegaso	RH	✓		✓	✓	✓		✓	✓	A	✓		HC-CARGO 170665

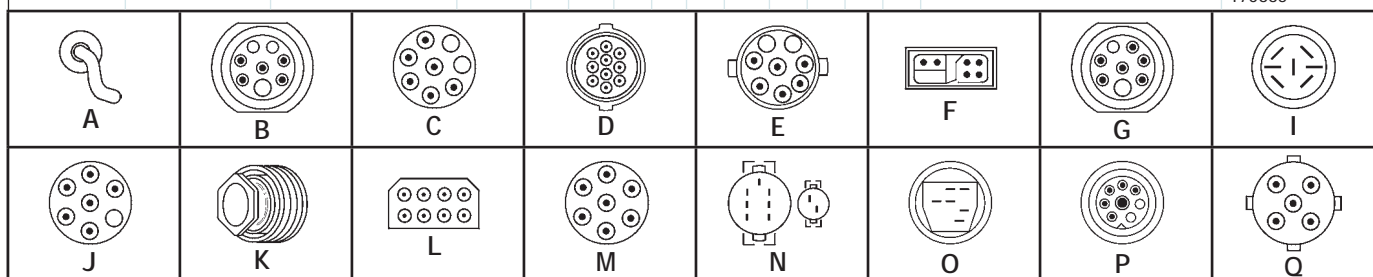

HC-CARGO	Dimension	Servicing	Right / Left	Flasher light	Number Plates light	Rear fog lamp	Reflector	Reverse light	Side marker lamp	Stop light	Tail light	Connection	E-Approval	Replacing	Lens
171506	350 x 130 x 85	DAF,Nissan, Renault.	RH/LH	✓	✓	✓	✓	✓		✓	✓	J			HC-CARGO 171507
171508	350 x 130 x 85	Commercial Trailers.	RH/LH	✓	✓	✓		✓		✓	✓	K			HC-CARGO 171509
171205	343 x 133 x 75	MAN, VW, Mercedes.	RH	✓		✓	✓			✓	✓	A	2vp003567-127, 21.147-071		HC-CARGO 171263
171206	343 x 133 x 75	MAN, VW, Mercedes.	LH	✓	✓	✓	✓	✓		✓	✓	A	2sl003567-691, 21.147-081		HC-CARGO 171263
170893	335 x 96 x 83		RH	✓						✓	✓	A	2sd001688-141, 21.002-031, 21.002-031, 21.002-021, 21.002-021, 170892		HC-CARGO 171062
170895	335 x 96 x 83		LH	✓						✓	✓	A	2sd001688-171, 21.002-071, 21.002-071		HC-CARGO 171062
171188	282 x 105 x 73		LH	✓	✓					✓	✓	A	2se001699-071, 2se001679-071, 21.001-021, 21.001-021		HC-CARGO 171234
171189	282 x 105 x 73		RH	✓						✓	✓	A	2sd001699-061, 21.001-031, 21.001-031		HC-CARGO 171234
171190	282 x 105 x 73		LH	✓						✓	✓	A	2sd001699-511, 2sd001699-071, 21.001-071, 21.001-071		HC-CARGO 171234
171209	281 x 99 x 56		LH	✓	✓	✓	✓			✓	✓	A	21.195-001		
171210	281 x 99 x 56		RH	✓	✓		✓	✓		✓	✓	A	21.195-011		

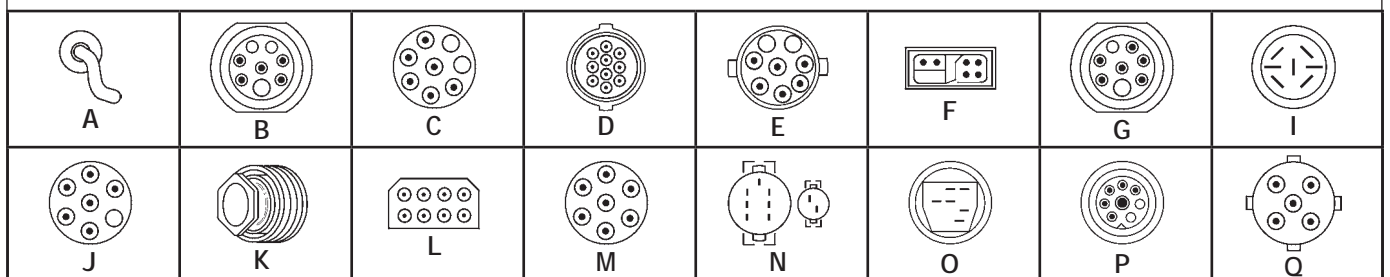



Bulbs

Edition 2014/2015



H1 Halogen

	HC-CARGO	Voltage	Watt	Length	OD	Colour	Type	Comment
 P14.5s	170069	12	55	62.5 mm	8.5 mm		Single filament	
	171070	12	55	62.5 mm	8.5 mm		Single filament	<i>Gives up to 30% more light.</i>
	171071	12	55	62.5 mm	8.5 mm	Xenon blue	Single filament	
	171136	12	55	62.5 mm	8.5 mm		Single filament	<i>Gives up to 50% more light.</i>
	171068	12	100	62.5 mm	8.5 mm		Single filament	
	171404	12	130	59.8 mm	9.7 mm		Single filament	
	171072	24	70	62.5 mm	8.5 mm		Single filament	

Jahn

	HC-CARGO	Voltage	Watt	Length	OD	Colour	Type	Comment
 P14.5s	170332	12	55	62.5 mm	8.5 mm		Single filament	
	170965	12	55	62.5 mm	8.5 mm		Single filament, Megalight	<i>Gives up to 30% more light.</i>
	170493	12	100	62.5 mm	8.5 mm		Single filament	
	170449	24	70	62.5 mm	8.5 mm		Single filament	
	170494	24	100	62.5 mm	8.5 mm		Single filament	

OSRAM

	HC-CARGO	Voltage	Watt	Length	OD	Colour	Type	Comment
 P14.5s	171686	12	55	58.9 mm	10.8 mm		Single filament, Nightbreaker	<i>Up to 90% more light. Up to 35 m longer beam. Up to 10% whiter light.</i>

H2 Halogen

	HC-CARGO	Voltage	Watt	Length	OD	Colour	Type	Comment
 X511	171073	12	55	30 mm	9 mm		Single filament	
	170512	24	100	30 mm	9 mm		Single filament	

Jahn







	HC-CARGO	Voltage	Watt	Length	OD	Colour	Type	Comment
 X511	170576	12	55	30 mm	9 mm		Single filament	

H3 Halogen

	HC-CARGO	Voltage	Watt	Length	OD	Colour	Type	Comment
 PK22s	171469	6	55	42 mm	11.5 mm		Single filament	
	170070	12	55	42 mm	11.5 mm		Single filament	
	171405	12	130	39 mm	11.5 mm		Single filament	
	170836	24	70	42 mm	11.5 mm		Single filament	
	171407	48	45	42 mm	11.5 mm		Single filament	
	171378	80	55	42 mm	11.5 mm		Single filament	

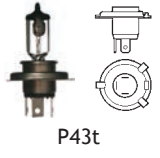
Jahn

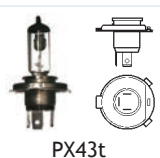
	HC-CARGO	Voltage	Watt	Length	OD	Colour	Type	Comment
 PK22s	170696	12	35	42 mm	11.5 mm		Single filament	
	170333	12	55	42 mm	11.5 mm		Single filament	
	170723	12	55	42 mm	11.5 mm		Single filament, All day	<i>Gives better visibility in poor weather conditions.</i>
	170824	12	55	42 mm	11.5 mm	Xenon blue	Single filament	<i>Brighter light as standard.</i>
	170412	24	70	42 mm	11.5 mm		Single filament	
	170362	24	100	42 mm	11.5 mm		Single filament	

John	HC-CARGO	Voltage	Watt	Length	OD	Colour	Type	Comment
 PKY22s	170496	12	100	42 mm	11.5 mm		Single filament	
OSRAM	HC-CARGO	Voltage	Watt	Length	OD	Colour	Type	Comment
 PK22s	171687	12	55	42 mm	10.8 mm		Single filament, Nightbreaker	Up to 90% more light. Up to 35 m longer beam. Up to 10% whiter light.
H4 Halogen								
HC CAR GO	HC-CARGO	Voltage	Watt	Length	OD	Colour	Type	Comment
 P43t	171474	6	60/55	78 mm	16 mm		Double filament	
	170768	12	60/55	78 mm	16 mm		Double filament	
	171066	12	60/55	78 mm	16 mm		Double filament	Gives up to 30% more light.
	171067	12	60/55	78 mm	16 mm	Xenon blue	Double filament	Brighter light as standard.
	171113	12	60/55	78 mm	16 mm		Double filament, Longlife	
	171114	12	60/55	78 mm	16 mm	Gold	Double filament	Gives better visibility in poor weather. Not approved in Germany.
	171134	12	60/55	78 mm	16 mm		Double filament	Gives up to 50% more light.
	170803	12	100/80	78 mm	16 mm	Xenon blue	Double filament	Brighter light as standard.
	171065	12	100/80	78 mm	16 mm		Double filament	
	170513	12	130/90	76.4 mm	14.6 mm		Double filament	
	170514	12	165/120	78 mm	16 mm		Double filament	
	170792	24	75/70	78 mm	16 mm		Double filament	
	171125	24	75/70	78 mm	16 mm		Double filament, Heavy Duty	
 P45t	170071	12	60/55	78 mm	16 mm		Double filament	
 PX43t	171473	6	35/35	78 mm	16 mm		HS1	
John	HC-CARGO	Voltage	Watt	Length	OD	Colour	Type	Comment
 P43t	170718	12	35/35	78 mm	16 mm		Double filament	
	170334	12	60/55	78 mm	16 mm		Double filament	
	170657	12	60/55	78 mm	16 mm		Double filament, Longlife	
	170802	12	60/55	78 mm	16 mm	Xenon blue	Double filament	Brighter light as standard.
	170804	12	60/55	78 mm	16 mm		Double filament, Megalight	Gives up to 30% more light.
	171064	12	60/55	78 mm	16 mm		Double filament, Megalight plus	Gives up to 60% more light.
	170009	12	100/90	78 mm	16 mm		Double filament	
	170348	24	75/70	78 mm	16 mm		Double filament	
	170450	24	75/70	78 mm	16 mm		Double filament, Heavy Duty	
	170360	24	100/70	78 mm	16 mm		Double filament	
 P45t	170681	12	45/40	78 mm	16 mm		Double filament	
	170359	12	100/80	78 mm	16 mm		Double filament	
	170006	24	75/70	78 mm	16 mm		Double filament	

	HC-CARGO	Voltage	Watt	Length	OD	Colour	Type	Comment
 P43t	171688	12	60/55	82 mm			Double filament, Nightbreaker	Up to 90% more light. Up to 35 m longer beam. Up to 10% whiter light.
MH6 Halogen								
	HC-CARGO	Voltage	Watt	Length	OD	Colour	Type	Comment
 PX15d	170811	12	30/30	47 mm	20 mm		Double filament, Bilux	
	170812	12	30/30	55 mm	15 mm		Double filament	
H7 Halogen								
	HC-CARGO	Voltage	Watt	Length	OD	Colour	Type	Comment
 PX26d	171077	12	55	58 mm	11.6 mm		Single filament	
	171079	12	55	58 mm	11.6 mm	Xenon blue	Single filament	Brighter light as standard.
	171081	12	55	58 mm	11.6 mm		Single filament	Gives up to 30% more light.
	171117	12	55	58 mm	11.6 mm		Single filament, Longlife	
	171137	12	55	58 mm	11.6 mm		Single filament	Gives up to 50% more light.
	170837	12	100	58 mm	11.6 mm		Single filament	
	171080	24	70	58 mm	11.6 mm		Single filament	
	171532	24	70	58 mm	11.6 mm		Single filament, Longlife	
Jahn	HC-CARGO	Voltage	Watt	Length	OD	Colour	Type	Comment
 PX26d	170720	12	55	58 mm	11.6 mm		Single filament	
	170825	12	55	58 mm	11.6 mm	Xenon blue	Single filament	Brighter light as standard.
	170800	24	70	58 mm	11.6 mm		Single filament	
	HC-CARGO	Voltage	Watt	Length	OD	Colour	Type	Comment
 PX26d	171689	12	55	59 mm	11.4 mm		Single filament, Conventional, Nightbreaker	Up to 90% more light. Up to 35 m longer beam. Up to 10% whiter light.
H15 Halogen								
	HC-CARGO	Voltage	Watt	Length	OD	Colour	Type	Comment
 PGJ23T-1	171691	12	60/19		12.9 mm		Double filament	
H6W Halogen								
	HC-CARGO	Voltage	Watt	Length	OD	Colour	Type	Comment
 BAX9s	171082	12	6	35 mm	9 mm		Single filament	
Jahn	HC-CARGO	Voltage	Watt	Length	OD	Colour	Type	Comment
 BAX9s	170741	12	6	33 mm	9 mm		Single filament	

H21W Halogen									
	HC-CARGO	Voltage	Watt	Length	OD	Colour	Type	Comment	
 BAY9s	171083	12	21	40 mm	10 mm		Single filament		
	171084	24	21	40 mm	10 mm		Single filament		
 P26s	171135	12	15	36 mm	10 mm		Single filament		
	HC-CARGO	Voltage	Watt	Length	OD	Colour	Type	Comment	
 BAY9s	170742	12	21	40 mm	10 mm		Single filament		
HB1 American Types									
	HC-CARGO	Voltage	Watt	Length	OD	Colour	Type	Comment	
 P29t	170692	12	65/45	95 mm	16.5 mm		Halogen		
HB3 American Types									
	HC-CARGO	Voltage	Watt	Length	OD	Colour	Type	Comment	
 P20d	170693	12	65	78 mm	16 mm		Halogen		
HB3 A American Types									
	HC-CARGO	Voltage	Watt	Length	OD	Colour	Type	Comment	
 P20d	171804	12	60	70.9 mm	11.9 mm		Halogen		
HB4 American Types									
	HC-CARGO	Voltage	Watt	Length	OD	Colour	Type	Comment	
 P22d	170694	12	55	78 mm	16 mm		Halogen		
HB4 A American Types									
	HC-CARGO	Voltage	Watt	Length	OD	Colour	Type	Comment	
 P22d	171794	12	51	80.3 mm	10.7 mm		Halogen		
HB5 American Types									
	HC-CARGO	Voltage	Watt	Length	OD	Colour	Type	Comment	
 PX29t	171039	12	65/55	102 mm	17 mm		Halogen		

H8 American Types

Jahn	HC-CARGO	Voltage	Watt	Length	OD	Colour	Type	Comment
	171034	12	35	41 mm	11.7 mm		Halogen	
PGJ19-1								

H9 American Types

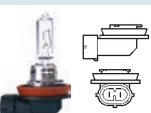
Jahn	HC-CARGO	Voltage	Watt	Length	OD	Colour	Type	Comment
	171035	12	65	41 mm	11.7 mm		Halogen	
PGJ19-5								

H10 American Types

Jahn	HC-CARGO	Voltage	Watt	Length	OD	Colour	Type	Comment
	171036	12	42	31.5 mm	12.4 mm		Halogen	
PY20d								

H11 American Types

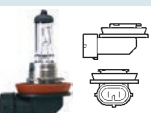

Jahn	HC-CARGO	Voltage	Watt	Length	OD	Colour	Type	Comment
	171037	12	55	41 mm	11.7 mm		Halogen	
PGJ19-2								

OSRAM	HC-CARGO	Voltage	Watt	Length	OD	Colour	Type	Comment
	171690	12	55	44 mm	11.4 mm		Single filament, Halogen, Nightbreaker	Up to 90% more light. Up to 35 m longer beam. Up to 10% whiter light.
PGJ19-2								

H13 Halogen

Jahn	HC-CARGO	Voltage	Watt	Length	OD	Colour	Type	Comment
	171796	12	60/55	86 mm	16.1 mm		Double filament	
P26.4t								

H27W/1 American Types

Jahn	HC-CARGO	Voltage	Watt	Length	OD	Colour	Type	Comment
	171009	12	27	44.5 mm	10.3 mm		Halogen	
PG13								
	170710	12	27/7	53 mm	26.5 mm		Halogen, 3157	
	170711	12	27/7	53 mm	26.5 mm	Orange	Halogen, 3157NA	
W2.5x16q								

H27W/2 American Types

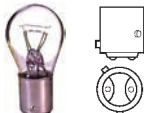
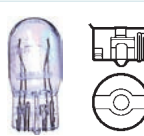

HC-CARGO	HC-CARGO	Voltage	Watt	Length	OD	Colour	Type	Comment
	171953	12	50	62.7 mm	12.5 mm		Halogen	
PGJ13								

John	HC-CARGO	Voltage	Watt	Length	OD	Colour	Type	Comment
 PGJ13	171010	12	27	44.5 mm	10.3 mm		Halogen	
	170951	12	50	62.7 mm	12.5 mm		Halogen	
	170726	12	37.5	62.7 mm	12.5 mm		Halogen	
High Intensity Discharge								
OSRAM	HC-CARGO	Voltage	Watt	Length	OD	Colour	Type	Comment
 P32d-2	171133	85	35	77 mm	13.7 mm	4150K	Electronic gas, D2S	
	171132	85	35	79.7 mm	13.7 mm	4150K	Electronic gas, D2R	
 P32d-3	171713	42	35	77 mm	13.7 mm	4150K	Electronic gas, D4S	
	171711	42	35	79.7 mm	12.4 mm	4150K	Electronic gas, D4R	
 P32d-5	171710	42	35	80 mm	13 mm	4150K	Electronic gas, D3R	
	171613	85	35	82 mm	41x41 mm	4150K	Electronic gas, D1S	
 PK-32d-6	171683	85	35	80 mm	13 mm	4150K	Electronic gas, D1R	
	171712	42	35	80 mm	13 mm	4150K	Electronic gas, D3S	
 PK32d-2	171683	85	35	80 mm	13 mm	4150K	Electronic gas, D1R	
	171712	42	35	80 mm	13 mm	4150K	Electronic gas, D3S	
 PK32d-3	171712	42	35	80 mm	13 mm	4150K	Electronic gas, D3S	
	171712	42	35	80 mm	13 mm	4150K	Electronic gas, D3S	
 PK32d-5	171712	42	35	80 mm	13 mm	4150K	Electronic gas, D3S	
	171712	42	35	80 mm	13 mm	4150K	Electronic gas, D3S	
Stop and Tail Lamps								
CAR GO	HC-CARGO	Voltage	Watt	Length	OD	Colour	Type	Comment
 BAY15d	170770	12	21/5	50 mm	25 mm			
	171092	24	21/5	50 mm	25 mm			
 BAZ15d	171093	12	21/4	50 mm	25 mm			
	171093	12	21/4	50 mm	25 mm			

Jahn	HC-CARGO	Voltage	Watt	Length	OD	Colour	Type	Comment
 BAY15d	171476	6	21/5	52.5 mm	26.5 mm			
	170337	12	20/5	52.5 mm	26.5 mm			
	170336	12	21/5	52.5 mm	26.5 mm		P21/5W	
	170659	12	21/5	52.5 mm	26.5 mm		Longlife	
	170724	12	26/8	47.2 mm	24.9 mm			
	170453	24	20/5	52.5 mm	26.5 mm			
	170452	24	21/5	52.5 mm	26.5 mm			
 BAZ15d	170644	12	21/4	52.5 mm	26.5 mm			
	170850	24	21/4	52.5 mm	26.5 mm			
 T20	170776	12	21/5	44 mm	20 mm			

Festoon

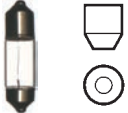
	HC-CARGO	Voltage	Watt	Length	OD	Colour	Type	Comment
 S8.5	171487	6	10	36 mm	10.5 mm			
	171094	12	5	36 mm	10.5 mm			
	171097	12	5	41 mm	10.5 mm			
	171095	12	10	36 mm	10.5 mm			
	171098	12	10	41 mm	10.5 mm			
	171120	12	21	41 mm	15 mm			
	171096	24	5	36 mm	10.5 mm			
	171099	24	5	41 mm	10.5 mm			
	171100	24	10	41 mm	10.5 mm			

Jahn	HC-CARGO	Voltage	Watt	Length	OD	Colour	Type	Comment
 S6	170591	12	3	33 mm	8.5 mm			
	171485	6	3	28 mm	8 mm			
 S7	170590	12	3	28 mm	8 mm			
	171484	6	5	36 mm	10.5 mm			
 S8.5	171488	6	5	41 mm	10.5 mm			
	171489	6	10	41 mm	10.5 mm			
	171486	6	15	41 mm	15 mm			
	171479	6	18	41 mm	15 mm			
	170341	12	5	36 mm	10.5 mm		C5W	
	170343	12	5	41 mm	10.5 mm			
	170005	12	10	28 mm	10 mm			
	170344	12	10	41 mm	10.5 mm			
	170411	12	10	36 mm	10.5 mm			
	170342	12	15	41 mm	15 mm			
	170588	12	18	41 mm	15 mm			
	171139	12	21	41 mm	15 mm			
	170414	24	5	36 mm	10.5 mm		C5W	
	170415	24	5	41 mm	10.5 mm			
	170475	24	10	41 mm	10.5 mm			
	170592	24	15	41 mm	15 mm			
	170589	24	18	41 mm	15 mm			

Parking and Flasher - Postion

	HC-CARGO	Voltage	Watt	Length	OD	Colour	Type	Comment
 BA15d	171102	24	5	35 mm	18.5 mm			
 BA15S	170773	12	5	35 mm	18.5 mm			
	170794	24	5	35 mm	18.5 mm			
	171118	24	5	35 mm	18.5 mm			
 BA7s	171119	12	2	19 mm	6.8 mm			
 BA9s	171490	6	3	27.4 mm	8.6 mm			
	171103	12	2	23 mm	8.6 mm			
	170774	12	4	27.4 mm	8.6 mm			
	170822	12	4	27.4 mm	8.6 mm	Xenon blue		Brighter light as standard.
	170796	24	2	23 mm	8.6 mm			
	170795	24	4	27.4 mm	8.6 mm			
 T15	171401	12	5	36 mm	15 mm			
Jahn	HC-CARGO	Voltage	Watt	Length	OD	Colour	Type	Comment
 BA15d	170593	12	5	35 mm	18.5 mm			
	170482	24	5	35 mm	18.5 mm			
 BA15S	171481	6	5	35 mm	18.5 mm			
	171480	6	10	35 mm	18.5 mm			
	171472	6	18	45 mm	26.5 mm			
	170340	12	5	35 mm	18.5 mm		R5W	
	170660	12	5	35 mm	18.5 mm			Longlife
	170339	12	10	35 mm	19 mm			
	170413	24	5	35 mm	18.5 mm		R5W	
	170455	24	5	35 mm	18.5 mm			
 BA7s	171483	6	1.5	20.7 mm	6.8 mm	White		
	170448	12	2	20.7 mm	6.8 mm			
	170456	24	3	20.7 mm	6.8 mm			
 BA9s	171491	6	2	27.4 mm	8.6 mm			
	171492	6	4	27.4 mm	8.6 mm			
	170345	12	2	23 mm	8.6 mm			
	170594	12	3	23 mm	8.6 mm			
	170346	12	4	27.4 mm	8.6 mm		T4W	
	170580	12	5	29 mm	15.5 mm			
	170416	24	2	23 mm	8.6 mm		T2W	
	170474	24	3	23 mm	8.6 mm			
	170417	24	4	27.4 mm	8.6 mm		T4W	
	170503	24	4	27.4 mm	8.6 mm			

Wedge Base

	HC-CARGO	Voltage	Watt	Length	OD	Colour	Type	Comment
 T10	171121	12	2	26 mm	10 mm			
	171104	12	3	26 mm	10 mm			
	170948	12	5	26 mm	10.3 mm	Xenon blue		Brighter light as standard.
	171105	12	5	26 mm	10 mm			
	171122	12	5	26 mm	10 mm	Blue		
	171123	12	5	26 mm	10 mm	Orange		
	170810	12	8	26 mm	10 mm			
	171106	24	3	26 mm	10 mm			
 T5	171107	24	5	26 mm	10 mm			
	170775	12	1.2	20 mm	5 mm			
 T7	171108	24	1.2	20 mm	5 mm			
	171391	12	3	20 mm	7 mm			
Jahn	HC-CARGO	Voltage	Watt	Length	OD	Colour	Type	Comment
 T10	170725	12	2	26.7 mm	10.3 mm			
	170331	12	3	26.7 mm	10.3 mm		W3W	
	170778	12	3	26.7 mm	10.3 mm	Orange	W3W	
	170779	12	3	26.7 mm	10.3 mm	Green	W3W	
	170780	12	3	26.7 mm	10.3 mm	Blue	W3W	
	170781	12	3	26.7 mm	10.3 mm	Red	W3W	
	170347	12	5	26.7 mm	10.3 mm		W5W	
	170662	12	5	26.7 mm	10.3 mm		W5W, Longlife	
	170754	12	5	26.7 mm	10.3 mm	Orange	WY5W	
	1711027	24	2	26.7 mm	10.3 mm			
	170476	24	3	26.7 mm	10.3 mm		W3W	
	170805	24	3	26.7 mm	10.3 mm	Orange	W3W	
	170806	24	3	26.7 mm	10.3 mm	Green	W3W	
	170807	24	3	26.7 mm	10.3 mm	Blue	W3W	
	170808	24	3	26.7 mm	10.3 mm	Red	W3W	
 T5	170542	24	5	26.7 mm	10.3 mm		W5W	
	171283	12	2	20 mm	5 mm			
	170410	12	1.2	20 mm	5 mm			
	170617	12	1.2	20 mm	5 mm	Frosted		
	171386	24	2	20 mm	5 mm			
	170684	24	0.7	20 mm	5 mm			
170477	24	1.2	20 mm	5 mm				









Instrument Panel

	HC-CARGO	Voltage	Watt	Length	OD	Colour	Socket colour	Comment
 B8.4d	171110	12	2	17.5 mm	5 mm		Light green	
	171109	12	1.2	17.5 mm	5 mm		Black	
	171381	12	1.2	17.5 mm	5 mm		Blue	
	171023	12	1.5	17.5 mm	5 mm		Beige	
	171030	24	1.2	16.5 mm	5 mm		Brown	
 B8.5d	171379	12	1	21 mm	5 mm		Orange	
	171024	12	1.2	21 mm	5 mm		Blue	
	171383	12	1.5	21 mm	5 mm		Beige	
	171380	12	0.36	21 mm	5 mm		Purple	
	171028	24	1.2	21 mm	5 mm		Brown	



	HC-CARGO	Voltage	Watt	Length	OD	Colour	Socket colour	Comment
 B8.7d	171455	12	2	16.5 mm	5 mm		Green	
 BX2d	171284	12	1.2	21.5 mm	5 mm		Black	
 EBSN10	171377	24	1.2	20 mm	6 mm		Beige	<i>Alba- type.</i>
 EBSR11	171031	12	1.2	20 mm	5 mm		Green	<i>Alba- type.</i>
	170698	12	1.8	20 mm	5 mm		Blue	<i>Alba- type.</i>
	171025	24	1.2	21 mm	5 mm		Yellow	<i>Alba- type.</i>
	171026	24	1.2	21 mm	5 mm		Brown	<i>Alba- type.</i>
	171032	24	1.4	21 mm	5 mm		Green	<i>Alba- type.</i>
 F4.8	171112	14	1.2	13 mm	4.8 mm		Black	
 MFHZ	171382	12	1.2	38 mm	5 mm		Black	
 MFJF	171837	12	2	35 mm	5 mm		Black	
	171384	12	1.2	35 mm	5 mm		Black	
 T-1/4	170364	14	1.12	10.5 mm	4 mm			
 T-1/4NW	170762	14	0.8	9 mm	3.4 mm		Dark grey	
	171389	14	1.4	11 mm	3.5 mm		Black	
 T-3/4	170972	12	0.6	6.5 mm	2.5 mm			<i>Used as locating light bulbs in switches on japanese vehicles.</i>
 T5	171388	12	0.4	20 mm	5 mm	Frosted	Grey	
	171029	24	1.2	20 mm	5 mm		White	
 T7	171111	14	2	23 mm	7 mm		Pink	

ACCESSORIES - Lighting

O.E.M. names and numbers are used for reference purposes only.

Jahn	HC-CARGO	Voltage	Watt	Length	OD	Colour	Socket colour	Comment
 B8.3d	170611	12	2	23.5 mm	5 mm		White	
	170612	12	1.2	23.5 mm	5 mm		Black	
	170613	24	1.2	23.5 mm	5 mm		Grey	
 B8.4d	170756	12	2	17.5 mm	5 mm		Light green	
	170727	12	1.2	17.5 mm	5 mm		Black	
	171033	12	1.12	17.5 mm	5 mm		Orange	
 B8.5d	170610	12	2	23.5 mm	5 mm		Green	
	170357	12	1.2	23.5 mm	5 mm		Black	
	170358	24	1.2	23.5 mm	5 mm		Grey	
 B8.7d	170545	12	1.2	23.5 mm	5 mm		Grey	
 EBSR10	171454	24	1.2	20 mm	5 mm	Frosted	White	
 F4.8	170753	14	1.4	12 mm	5 mm		Black	
 T5	170755	12	0.5	19.5 mm	5 mm		Grey	
	170758	12	1.2	20 mm	5 mm		White	
	170782	12	1.2	20 mm	5 mm	Orange		
	170783	12	1.2	20 mm	5 mm	Green		
	170784	12	1.2	20 mm	5 mm	Blue		
	170785	12	1.2	20 mm	5 mm	Red		
 T7	170757	14	2	23.5 mm	5 mm		White	

Conventional

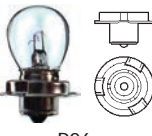
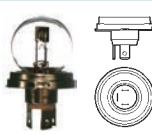

HC-CAR GO	HC-CARGO	Voltage	Watt	Length	OD	Colour	Type	Comment
 P45t	170771	12	45/40	77 mm	41 mm		Bilux	
Jahn	HC-CARGO	Voltage	Watt	Length	OD	Colour	Type	Comment
 BA15S	170577	12	45	53 mm	36 mm			For US and UK systems.
	170578	24	45	53 mm	36 mm			For US and UK systems.
 BA20d	171531	6	35/35	70 mm	36 mm			
	170814	12	25/25	70 mm	36 mm			
	170815	12	35/35	70 mm	36 mm			
	170573	12	45/40	70 mm	36 mm			
	170574	24	45/40	70 mm	36 mm			

John	HC-CARGO	Voltage	Watt	Length	OD	Colour	Type	Comment
 BA20s	170575	12	35	66 mm	36 mm			
	170579	12	50	66 mm	36 mm			For German and Italian systems.
 P26s	170816	12	15	46 mm	25.5 mm			
 P45t	171477	6	45/40	77 mm	41 mm		Bilux	
	170338	12	45/40	77 mm	41 mm		Bilux	
	170350	24	55/50	77 mm	41 mm		Bilux	



Electric Vehicles and Forklifts





















CARGO	HC-CARGO	Voltage	Watt	Length	OD	Colour	Type	Comment
 BA15S	171410	48	10	35 mm	16 mm			
	171408	48	25	50 mm	25 mm			
 BAY15d	171411	48	25/10	50 mm	25 mm			
 PK22s	171407	48	45	42 mm	11.5 mm		Halogen, H3	
	171378	80	55	42 mm	11.5 mm		Halogen, H3	

Flash and Penlight

CARGO	HC-CARGO	Voltage	Watt	Length	OD	Colour	Type	Comment
 E10	170509	12	3	24 mm	11.5 mm			
	170674	24	2	24 mm	11.5 mm			
 P13.5s	171280	48		30 mm	11 mm		Krypton	



Wedge Base - Covers

John	HC-CARGO	Voltage	Watt	Length	OD	Colour	Type	Comment
	170731					Blue		
	170732					Green		
	171127					Orange		

<i>Jahn</i>	HC-CARGO	Voltage	Watt	Length	OD	Colour	Type	Comment
	171128					Blue		
	171129					Green		
	171130					Red		
	171131					Orange		
Halogen								
	HC-CARGO	Voltage	Watt	Length	OD	Colour	Type	Comment
  BA9s	170470	12	5	33 mm	9 mm			
	170502	12	12	33 mm	9 mm			
	170380	12	20	35 mm	9 mm			
  G4	171425	12	5	30 mm	8 mm			
	170712	12	10	30 mm	8 mm			
	170749	12	20	30 mm	8 mm			
	170848	24	10	30 mm	8 mm			
  G4	170750	24	20	30 mm	8 mm			
	171124	12	5	33 mm	9 mm			
  T10	171124	12	5	33 mm	9 mm			
	171124	12	5	33 mm	9 mm			
<i>Jahn</i>	HC-CARGO	Voltage	Watt	Length	OD	Socket colour	Type	Comment
  B10d	170751	12	3	27.8 mm	8.8 mm	Brown		
	170752	12	5	27.8 mm	8.8 mm	Black		
  BA15S	170839	12	10	37.5 mm	10 mm			
	171748	12	50					American, 885
  PG13	171747	12	27					American, 3156
	171747	12	27					American, 3156
 W2.5x16d	171747	12	27					American, 3156
	171747	12	27					American, 3156

Stop and Flasher - Position

	HC-CARGO	Voltage	Watt	Length	OD	Colour	Type	Comment
 BA15d	171088	24	15	43 mm	23 mm			
	170772	12	10	35 mm	18 mm			
 BA15S	170769	12	21	50 mm	25 mm			
	171091	12	21	50 mm	25 mm	Orange		
	170793	24	10	35 mm	18 mm			
	171076	24	10	35 mm	18 mm			
	171086	24	15	43 mm	23 mm			
	170826	24	21	50 mm	25 mm			
	171078	24	21	50 mm	25 mm			
 BAU15s	171089	12	21	50 mm	25 mm	Orange		
	171371	12	21	50 mm	25 mm	Silver/amber		
	171090	24	21	50 mm	25 mm	Orange		
 PG20/4	171869	12	24			Orange		300 lm.
 T13	171390	12	10	30 mm	13 mm			
 T15	171402	12	10	36 mm	15 mm			
	171403	12	21	36 mm	15 mm			
John	HC-CARGO	Voltage	Watt	Length	OD	Colour	Type	Comment
 BA15d	171470	6	15	45 mm	26.5 mm			
	170583	12	15	45 mm	26.5 mm			
	170585	12	20	45 mm	26.5 mm			
	170673	12	20/5	52.5 mm	22.5 mm			
	170507	24	15	45 mm	26.5 mm			
	170481	24	20	45 mm	26.5 mm			
 BA15S	171471	6	20	45 mm	26.5 mm			
	171475	6	21	52.5 mm	26.5 mm			
	170663	12	10	35 mm	19 mm		Longlife	
	170584	12	15	35 mm	19 mm			
	170586	12	18	45 mm	26.5 mm			
	170335	12	21	52.5 mm	26.5 mm		P12W	
	170658	12	21	52.5 mm	26.5 mm		Longlife	
	170351	24	10	35 mm	19 mm		R10W	
	170454	24	10	35 mm	15 mm			
	170480	24	15	45 mm	26.5 mm			
	170938	24	15	35 mm	19 mm			
	170761	24	18	45 mm	26.5 mm			
	170349	24	21	52.5 mm	26.5 mm		P21W	
	170451	24	21	52.5 mm	26.5 mm			
170614	24	25	45 mm	26.5 mm				
 BAU15s	170648	12	21	52.5 mm	26.5 mm	Orange	PY21W	
	170849	24	21	52.5 mm	26.5 mm	Orange		

<i>Jahn</i>	HC-CARGO	Voltage	Watt	Length	OD	Colour	Type	Comment
 T16	170813	12	16	37 mm	15 mm			
 T20	170777	12	21	44 mm	20 mm			
	171398	12	21	44 mm	20 mm	Orange		

Spare Lamp Kits

For Cars

Jahn



171040



171042



171043

Dimensions: 90 x 90 x 57 mm.

Contains:

HC-CARGO	TYPE	Jahn Ref. No.	Description	H4 171040	H7 171042	H1/H7 171043
170804	H4	1134	12 V. 60/55 W. P43t.	1		
170332	H1	1111	12 V. 55 W. P14.5s.		1	
170720	H7	1117	12 V. 55 W. PX 26d.		1	1
170335	P12W	1321	12 V. 21 W. BAY15s.	1	1	1
170336	P21/5W	1341	12 V. 21/5W. BAY15d.	1	1	1
170648	PY21W	1383	12 V. 21W. BAU15s.		1	1
170347	W5W	1621	12 V. 5 W. W2.1 x 9.5d.		1	1
170340	R5W	1401	12 V. 5 W. BA15s.	1	1	
170341	C5W	1711	12 V. 5 W. SV8.5.		1	1
170346	T4W	1501	12 V. 5 W. SV8.5.	1		
190057	ATO blade fuse		10 Amp. Red.	1	1	1
190058	ATO blade fuse		15 Amp. Blue.	1	1	1
190059	ATO blade fuse		20 Amp. Yellow.	1	1	1

For Trucks and Buses

Jahn

Contains:

HC-CARGO	TYPE	Jahn Ref. No.	Description	H4 171044
170348	H4	1102	24 V. 75/70W P43t.	2
170417	T4W	1502	24 V. 4 W. BA9s.	2
170413	R5W	1402	24 V. 5 W. BA15s.	1
170351	R10W	1412	24 V. 10 W. BA15s.	1
170349	P21W	1322	24 V. 21 W. BA15s.	4
170416	T2W	1512	24 V. 2 W. BA9s.	2
170475	Fest. T10.5	1732	24 V. 10 W. SV8.5.	1
170414	C5W	1712	24 V. 5 W. SV8.5.	1
190057	ATO blade fuse		10 Amp. Red.	1
190058	ATO blade fuse		15 Amp. Blue.	1
190059	ATO blade fuse		20 Amp. Yellow.	1
190060	ATO blade fuse		25 Amp. Natural.	1



171044

Dimensions: 210 x 95 x 60 mm.



Assortments

Edition 2014/2015



ASSORTMENTS
BOXES
200663 Assortment Box
Can be divided using inserts.

 Length: 265 m
 Thickness: 57 mm
 Width: 340 mm

Material: Polypropylene

200875 Carry Lite Assortment Box

 Length: 413 m
 Thickness: 57 mm
 Width: 330 mm

 Colour: Anthracite
 Material: Polypropylene

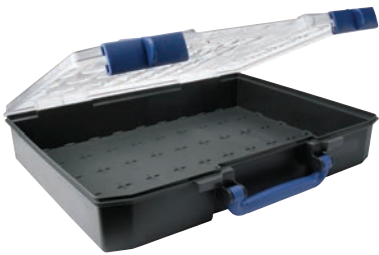
200876 Carry Lite Assortment Box
80-01.

 Length: 413 m
 Thickness: 79 mm
 Width: 330 mm

 Colour: Anthracite
 Material: Polypropylene

200877 Carry Lite Assortment Box

 Length: 413 m
 Thickness: 147 mm
 Width: 330 mm

 Colour: Anthracite
 Material: Polypropylene

200878 Foam

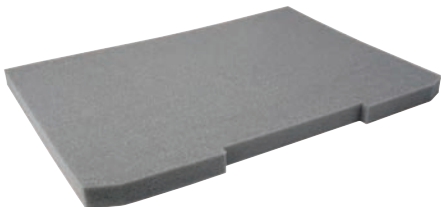
 Servicing: Carry Lite - Visit www.HC-CARGO.com for further information

 Length: 389 m
 Thickness: 22 mm
 Width: 284 mm

 Colour: Anthracite
 Material: Plastic

200879 Rail Set
For CL-box.

INSERTS			
200664 Insert			
<i>Unbreakable.</i>			
		Length: 40.00 m Thickness: 45.00 mm Width: 55.00 mm	Material: Polypropylene
200665 Insert			
<i>Unbreakable.</i>			
		Length: 110.00 m Thickness: 45.00 mm Width: 40.00 mm	Material: Polypropylene
200666 Insert			
<i>Unbreakable.</i>			
		Length: 165.00 m Thickness: 45.00 mm Width: 40.00 mm	Material: Polypropylene
200667 Insert			
<i>Unbreakable.</i>			
		Length: 220.00 m Thickness: 45.00 mm Width: 40.00 mm	Material: Polypropylene
200668 Insert			
<i>Unbreakable.</i>			
		Length: 80.00 m Thickness: 45.00 mm Width: 55.00 mm	Material: Polypropylene
200669 Insert			
<i>Unbreakable.</i>			
		Length: 160.00 m Thickness: 45.00 mm Width: 55.00 mm	Material: Polypropylene

200670 Insert

Unbreakable.

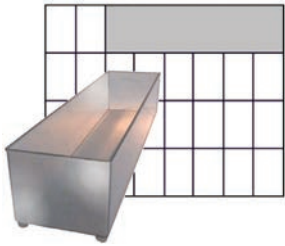

Length: 240.00 m
Thickness: 45.00 mm
Width: 55.00 mm

Material: Polypropylene

200671 Insert

Unbreakable.

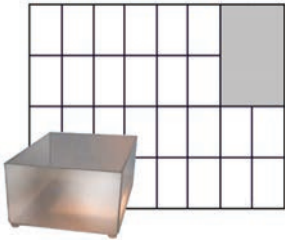

Length: 110.00 m
Thickness: 45.00 mm
Width: 80.00 mm

Material: Polypropylene

200672 Insert

Unbreakable.

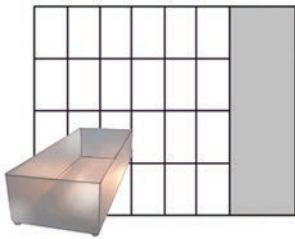

Length: 220.00 m
Thickness: 45.00 mm
Width: 80.00 mm

Material: Polypropylene

200673 Insert

Unbreakable.

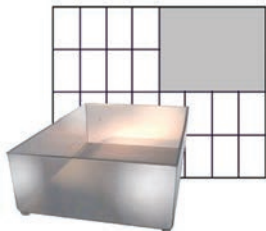

Length: 160.00 m
Thickness: 45.00 mm
Width: 110.00 mm

Material: Polypropylene

DISPLAY

200676 Display for 4 Assortments

Frame for 4 Profi service cases.



Length: 200.00 m
Thickness: 330.00 mm
Width: 360.00 mm

200693 Assortment Display

Frame for 4 Profi service cases. Can be assembled horizontally or vertically.



Length: 265.00 m
Thickness: 313.00 mm
Width: 373.00 mm

Bulb Holders

809001

	Qty.
170136	5
170137	5
170138	5
170139	5
170433	5
170135	5
170596	5
170619	3
170763	3
170790	5
170791	5
170799	3
170827	5

	Qty.
191938	100
193026	100

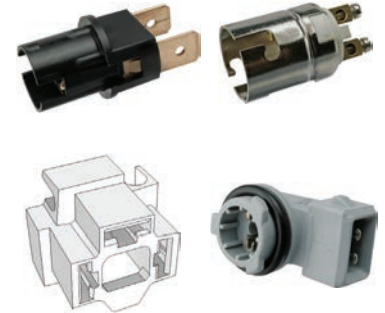
Feston Bulbs 12 V

809002

	Qty.
170005	20
170344	20
170343	20
170341	20
170411	20
170588	20
170590	20
170591	20

Wedge-Base Bulbs 12 V - I

809003

	Qty.
170331	20
170347	20
170357	20
170410	20
170545	20
170610	10
170612	10
170611	10
170617	10
170698	10
170364	20

Wedge-Base Bulbs 24 V

809004

	Qty.
170358	10
170476	10
170477	10
170542	10
170613	10
170684	10
170805	10
171026	10
170806	10
170807	10
170808	10
171025	20
171027	10
171028	10

	Qty.
171029	10
171032	10



Wedge-Base Bulbs 12 V - II

809005

	Qty.
170410 Bulb	10
170727 Bulb	5
170617 Bulb	10
170611 Bulb	10
170758 Bulb	5
170756 Bulb	5
170357 Bulb	10
170545 Bulb	10
170610 Bulb	10
170753 Bulb	5
170612 Bulb	10
170752 Bulb	5
170754 Bulb	5
170972 Bulb	10

	Qty.
170698 Bulb	5
170757 Bulb	5
170762 Bulb	5
170732 Bulb Cover	10
170755 Bulb	5
170347 Bulb	10
170331 Bulb	10
170364 Bulb	10
170731 Bulb Cover	10
170751 Bulb	5



Wedge-Base Bulbs 12 V - III

809006

	Qty.
170594 Bulb	10
170448 Bulb	10
170346 Bulb	20
170822 Bulb	5
170948 Bulb	5
170345 Bulb	10
170780 Bulb	10
170781 Bulb	10
170782 Bulb	10
170783 Bulb	10
170784 Bulb	10
170785 Bulb	10
170725 Bulb	10
170778 Bulb	10

	Qty.
170779 Bulb	10



Wedge-Base Bulbs 12 - 24 V

809007

	Qty.
170347 Bulb	10
170331 Bulb	10
170357 Bulb	10
170358 Bulb	10
170364 Bulb	10
170410 Bulb	10
170476 Bulb	10
170477 Bulb	10
170542 Bulb	10
170545 Bulb	10
170613 Bulb	10
170612 Bulb	10
170611 Bulb	10
170610 Bulb	10

	Qty.
170617 Bulb	10
170684 Bulb	10



Scooter Bulbs

809008

	Qty.
170335 Bulb	5
170336 Bulb	5
170339 Bulb	5
170340 Bulb	5
170810 Bulb	5
170811 Bulb	2
170812 Bulb	2
170814 Bulb	3
170815 Bulb	3
170816 Bulb	5



Wedge-Base Bulbs 12 V - IV

809009

	Qty.
171379 Bulb	10
171380 Bulb	10
171381 Bulb	10
171382 Bulb	10
171383 Bulb	10
171384 Bulb	10
171385 Bulb	10
171387 Bulb	10
171024 Bulb	10
171388 Bulb	10
171023 Bulb	10
171389 Bulb	10
171284 Bulb	10
171031 Bulb	10

	Qty.
171033 Bulb	10
171391 Bulb	10





Electrical Components

Edition 2014/2015



CAMERA & PARKING SENSORS

CCTV REAR OBSERVATION SYSTEM

160775 Rear Observation Kit

Kit consisting of 1x7" monitor w/ quad: HC-CARGO 160776. 1x colour camera w/ audio: HC-CARGO 160796. 1x20 m extension cable: HC-CARGO 160611.



Voltage: 12/24

Extension cable: 20 m
Height: 140 mm
Depth: 50.8 mm
Display size: 7"
Width: 191 mm
Wide angle: 60°

Monitor: LED
Type: Camera kit
Camera type: Colour
Accessories: DVD
No./cameras: 4+1
Audio: Yes
Extra camera: w/
Infrared: w/

160783 Rear Observation Kit

Kit consisting of 1x7" monitor: HC-CARGO 160784. 1x colour camera: HC-CARGO 160796. 1x20 m extension cable: HC-CARGO 160611.



Voltage: 12/24

Extension cable: 20 m
Height: 140 mm
Depth: 50.8 mm
Display size: 7"
Width: 191 mm
Wide angle: 60°

Monitor: LED
Type: Camera kit
Camera type: Colour
Accessories: DVD
No./cameras: 3+1
Remote control: w/o
Audio: Yes
Extra camera: w/
Infrared: w/

160793 Rear View Mirror Monitor kit

w/o camera and extension cable. Camera: HC-CARGO 160610, 160796. Extension cables: HC-CARGO 160611, 160612, 160613, 160672.



Voltage: 12/24

Display size: 4.3"

Camera type: Colour
Accessories: DVD
Audio: Yes

160994 Rear Observation Kit

Consists: 1x7" monitor w/ remote control: HC-CARGO 160995. 1x colour camera: HC-CARGO 160887. 1x20 m extension cable: HC-CARGO 160888.



Voltage: 12-24

Extension cable: 20 m
Display size: 7"

Monitor: TFT-LCD
Type: Camera kit
Camera type: Colour
No./cameras: max. 2
Remote control: w/
Audio: Yes
Extra camera: w/
Infrared: w/
Language: Chinese, German, English, French, Dutch, Italian, Japanese, Portuguese, Spanish

160996 Rear Observation Kit

Consists: 1x5" monitor w/ remote control: HC-CARGO 160997. 1x colour camera: HC-CARGO 160887. 1x20 m extension cable: HC-CARGO 160888.



Voltage: 12-24

Extension cable: 20 m
Display size: 5"

Monitor: TFT-LCD
Type: Camera kit
Camera type: Colour
No./cameras: max. 2
Remote control: w/
Audio: Yes
Extra camera: w/
Infrared: w/
Language: Chinese, German, English, French, Dutch, Italian, Japanese, Portuguese, Spanish

161005 Rear Observation Kit



Voltage: 12

Display size: 3.5"
Wide angle: 170°

Monitor: TFT-LCD
Type: Camera kit
Camera type: Colour - Wireless
No./cameras: 1
Remote control: w/o
Audio: No
Infrared: w/o
Language: Chinese, German, English, French, Dutch, Italian, Japanese, Portuguese, Spanish

161007 Rear Observation Kit

IP 67.



Voltage: 12-24

Display size: 7"

Monitor: TFT-LCD
 Type: Camera kit
 Camera type: Colour
 No./cameras: Max. 2
 Remote control: w/
 Audio: Yes
 Infrared: w/
 Language: Chinese, German, English, French, Dutch, Italian, Japanese, Portuguese, Spanish

CAMERAS

160610 CCTV Camera

Servicing: HC-CARGO 160775, 160783, 160793

w/ original anoised finish and anti-fog glas.



Voltage: 12
 Light sensitivity: 0.1 lux

OD: 30 mm
 Length: 70 mm
 Connection cable: 6 pin mini DIN
 Weight: 0.200 kg
 Resolution: >330 TV lines
 Shutter rate: 1/50-1/100.000 sec.
 Wide angle: 110°

Signal system: PAL
 Type: Colour
 Colour: Black
 Material: Aluminium
 Picture sensor: 1/3" CCD
 Microphone: w/o
 Mirror function: w/
 Protection degree: IP 68

160796 Colour Camera w/ Audio

Servicing: HC-CARGO 160775, 160783, 160793



Voltage: 12
 Light sensitivity: 0 lux

Connection cable: 1.3 m w/ 6 pin Mini DIN
 Height: 75 mm
 Depth: 60 mm
 Width: 90 mm
 Resolution: 420 TV lines
 Shutter rate: 1/50-1/100.000 sec.
 Wide angle: h: 122°

Signal system: PAL/NTSC
 Type: Colour
 Colour: White
 Material: Aluminium
 Picture sensor: 1/3" CCD
 Microphone: w/
 Infrared: w/
 Mirror function: w/
 Protection degree: IP 68

160880 Side Camera

Servicing: HC-CARGO 160775, 160783, 160793



Voltage: 12
 Light sensitivity: 0 lux/ IR LED on lux

Connection cable: 2 m
 Height: 60.7 mm
 Depth: 82.6 mm
 Width: 61.12 mm
 Resolution: 380 TV lines
 Shutter rate: 1/60-1/100.000 sec.
 Wide angle: 73°

Signal system: PAL
 Type: Colour
 Colour: Black
 Material: Aluminium
 Picture sensor: 1/4" CCD
 Microphone: w/o
 Infrared: w/
 Mirror function: w/
 Protection degree: IP 67

160887 Colour Camera

Servicing: HC-CARGO 160994, 160996



Voltage: 12/24
 Light sensitivity: 0 lux

Connection cable: 0.3 m 4 pin
 Height: 43 mm
 Depth: 57 mm
 Width: 75 mm
 Resolution: 420 TV lines
 Wide angle: 120°

Signal system: PAL
 Type: Colour
 Colour: Black
 Material: Aluminium
 Picture sensor: 1/3" CCD
 Microphone: w/
 Infrared: w/
 Mirror function: w/
 Protection degree: IP 68

160972 Colour Camera

Servicing: HC-CARGO 160994, 160996



Voltage: 12/24
 Light sensitivity: 0 lux

Connection cable: 0.3 m 4 pin
 Height: 43 mm
 Depth: 57 mm
 Width: 75 mm
 Resolution: 480 TV lines
 Wide angle: 95°

Signal system: PAL/NTSC
 Type: Colour
 Colour: Black
 Material: Aluminium
 Picture sensor: 1/3" CCD
 Microphone: w/
 Infrared: w/
 Mirror function: w/
 Protection degree: IP 68

	EL. SPECIFICATIONS	DIMENSIONS	ADDITIONAL SPECIFICATIONS
161006 Colour Camera w/ auto close			
	Servicing: HC-CARGO 160994, 160996		
	Voltage: 12-24 Light sensitivity: 0 lux	Connection cable: 0.5 m Resolution: 420 TV lines Wide angle: 140°	Signal system: PAL/NTSC Type: Colour Colour: Black Material: Aluminium Picture sensor: 1/3" CCD Microphone: w/o Infrared: w/ Protection degree: IP 68
MONITORS			
160776 Monitor			
	Servicing: HC-CARGO 160775		
	Voltage: 12/24	Display size: 7" Resolution: 1440x234 pixels	Signal system: PAL/NTSC Type: LED Mount. bracket: w/ Loudspeaker: Yes Mirror function: w/
160784 Monitor			
	Servicing: HC-CARGO 160783, 160793		
	Voltage: 12/24	Display size: 7" Resolution: 1440(W) x 234(H) pixels	Signal system: PAL/NTSC Type: TFT-LCD Mount. bracket: w/ Remote control: w/o Loudspeaker: Yes Mirror function: w/
160995 Monitor			
	Servicing: HC-CARGO 160994		
	Voltage: 12-24	Display size: 7" Resolution: 400x234 pixels	Signal system: PAL/NTSC Type: TFT-LCD Mount. bracket: w/ Remote control: w/ Loudspeaker: Yes Mirror function: w/o Language: Chinese, German, English, French, Dutch, Italian, Japanese, Portuguese, Spanish
160997 Monitor			
	Servicing: HC-CARGO 160996		
	Voltage: 12-24	Display size: 5" Resolution: 400x234 pixels	Signal system: PAL/NTSC Type: TFT-LCD Mount. bracket: w/ Remote control: w/ Loudspeaker: Yes Mirror function: w/o Language: Chinese, German, English, French, Dutch, Italian, Japanese, Portuguese, Spanish
ACCESSORIES			
160603 6 pin mini DIN to RCA connection			
<i>Used for connecting extra camera to switchbox.</i>			
	Servicing: HC-CARGO 160603		
			Plug: Mini Din 6 pin/RCA
160611 CCTV Extension Cable			
	Servicing: HC-CARGO 160775, 160783, 160793		
		Length: 20 m	Plug: Mini DIN 6 pin

EL. SPECIFICATIONS	DIMENSIONS	ADDITIONAL SPECIFICATIONS
160612 CCTV Extension Cable Servicing: HC-CARGO 160775, 160783, 160793		
	Length: 15 m	Plug: Mini DIN 6 pin
160613 CCTV Extension Cable Servicing: HC-CARGO 160775, 160783, 160793		
	Length: 10 m	Plug: Mini DIN 6 pin
160672 CCTV Extension Cable Servicing: HC-CARGO 160775, 160783, 160793		
	Length: 6 m	Plug: Mini DIN 6 pin
160888 CCTV Extension Cable Servicing: HC-CARGO 160994, 160996		
	Length: 20 m	Plug: 4 pin
160889 CCTV Extension Cable Servicing: HC-CARGO 160994, 160996		
	Length: 10 m	Plug: 4 pin
160916 Trailer Cable Kit Servicing: HC-CARGO 160994, 160996		
	Cable from socket to camera: 2 m Cable from socket to monitor: 5 m Coil length: 3 m	Trailer cable kit: 4 pin Plug: 4 pin
160961 Power Cable Servicing: HC-CARGO 160886		
	Voltage: 12-24	

160965 Lens

Servicing: HC-CARGO 160610



Material: Glass

160993 Trailer Cable Kit

Servicing: HC-CARGO 160775, 160783, 160793



Cable from socket to camera: 20 m
Cable from socket to monitor: 5 m
Coil length: 2 m

Plug: Mini DIN 6 pin

PARKING SENSORS

160884 Parking Sensor

4 sensors. *Wireless.*



Voltage: 9-14

Dim. display: 128x27x22 mm
Sensor dia.: 20 mm

160930 Parking Sensor

8 sensors. *Wireless.*



Voltage: 9-14

Dim. display: 128x27x22 mm
Sensor dia.: 20 mm

ACOUSTIC WARNING

REVERSING ALARMS

160346 Reversing Alarm

w/ "beep-beep" warning sound.



Voltage: 12
Watt: 10
Decibel: 90

Bulb type: Halogen
Socket type: BA15S
ADR-approved: No

160410 Reversing Alarm

w/ "beep-beep" warning sound.



Voltage: 24
Watt: 20
Decibel: 90

Bulb type: Halogen
Socket type: BA15S
ADR-approved: No

	EL. SPECIFICATIONS	DIMENSIONS	ADDITIONAL SPECIFICATIONS
160481 Reversing Alarm			
	Voltage: 12/24 Amp: 0.25 Decibel: 96 Hertz: 2500		Overvoltage: Yes Waterproof: Yes ADR-approved: No
160482 Reversing Alarm			
<i>Night attenuation, excluding when fog lights are on.</i>			
	Voltage: 12/24 Amp: 0.25 Decibel: 100 Hertz: 980		Overvoltage: Yes Waterproof: Yes ADR-approved: Yes
160689 Reversing Alarm			
	Voltage: 12/80 Amp: 30 Decibel: 85 Hertz: 3200		Type: Buzzer Waterproof: Yes ADR-approved: No
BUZZERS			
160533 Warning Buzzer			
	Voltage: 24 Miliamp: 21 Decibel: 99 Hertz: 400±100		
160534 Warning Buzzer			
	Voltage: 12 Miliamp: 25 Decibel: 97 Hertz: 400±100		
HORNS			
ELECTRICAL			
160036 Twin Fanfare Horn			
<i>Red w/ chromium grill.</i>			
	Voltage: 12 Decibel: 112 Hertz: 410-490		Relay: w/, Marine: No E-approval: Yes

160393 Horn

2 terminals. w/ bracket.

 Voltage: 36-48
 Amp: 1
 Decibel: 112
 Hertz: 420

OD: 100 mm

 Type: Single tone
 Material: Steel
 Marine: No
 E-approval: Yes

160414 Horn

Model EM2.

 Voltage: 24
 Amp: 4
 Decibel: 118
 Hertz: 370

Length: 400 mm

 Type: Single tone
 Material: Chromed brass
 Relay: w/o, Marine: Yes

160415 Horn

Model EM2.

 Voltage: 12
 Amp: 5
 Decibel: 118
 Hertz: 370

Length: 400 mm

 Type: Single tone
 Material: Chromed brass
 Relay: w/o, Marine: Yes

160658 Horn

 Servicing: VW - Visit www.hc-cargo.com for further information

w/ K-Jetronic connection. w/ bracket.

 Voltage: 12
 Amp: <1
 Hertz: 335

OD: 100 mm

 Type: Single tone
 Material: Steel
 Marine: No
 E-approval: Yes

160712 Horn

 Servicing: VW - Visit www.hc-cargo.com for further information

w/ K-Jetronic connection.



Voltage: 12

 OD: 82 mm
 Length: 117 mm

 Type: Dual tone
 Relay: w/o, Marine: No
 E-approval: Yes

160746 Horn

 Servicing: Scooters and motor cycles - Visit www.hc-cargo.com for further information

2 terminals. w/ bracket.

 Voltage: 12
 Amp: 1-1.4
 Decibel: 109
 Hertz: 410-550

OD: 70 mm

 Type: Single tone
 Material: Steel
 Marine: No
 E-approval: Yes

160986 Horn

2 terminals. w/ bracket.



Voltage: 12
Amp: 3.5
Decibel: 112
Hertz: 420

OD: 90 mm

Type: Single tone
Material: Steel
Marine: No
E-approval: Yes

160987 Horn

2 terminals. w/ bracket.



Voltage: 24
Amp: 2.5
Decibel: 112
Hertz: 420

OD: 90 mm

Type: Single tone
Material: Steel
Marine: No
E-approval: Yes

160988 Horn

2 terminals. w/ bracket.



Voltage: 12
Amp: 3.5
Decibel: 112
Hertz: 335

OD: 90 mm

Type: Single tone
Material: Steel
Marine: No
E-approval: Yes

160989 Horn

2 terminals. w/ bracket.



Voltage: 24
Amp: 2.5
Decibel: 112
Hertz: 335

OD: 90 mm

Type: Single tone
Material: Steel
Marine: No
E-approval: Yes

AIR HORNS

160002 Compressor Horn

w/ parts.



Voltage: 12
Amp: 16
Decibel: 117
Hertz: 630-795

Type: Dual tone
Material: Shockproof plastic
Relay: w/, E-approval: Yes

160038 Pneumatic Horn

Operating pressure 500-1200 kPa. For trucks equipped w/ on-board air.



Decibel: 118
Hertz: 330/370

OD: 80 mm
Length: 390 mm

Type: Dual tone
Material: Chromed Metal
E-approval: Yes

160048 Marine Horn

To be powered by electric air compressor HC-CARGO 160213. Audibility at least 1600 mtr. over open water.



Decibel: 120
Hertz: 380

Length: 385 mm
Capacity: 72 l/min

Material: Stainless steel
Marine: Yes

160355 Pneumatic Horn

 Servicing: Trucks - Visit www.hc-cargo.com for further information

Operating pressure 30-1200 kPa. Equipped w/ on-board air.

 Decibel: 118
Hertz: 210

 OD: 160 mm
Length: 600 mm

 Type: Single tone
Material: Chromed Metal
E-approval: Yes

160356 Pneumatic Horn

 Servicing: Trucks - Visit www.hc-cargo.com for further information

Operating pressure 30-1200 kPa. Equipped w/ on-board air.

 Decibel: 118
Hertz: 190

 OD: 160 mm
Length: 680 mm

 Type: Single tone
Material: Chromed Metal

160508 Compressor Horn

 Voltage: 24
Amp: 8
Decibel: 118
Hertz: 692-756

 Type: Dual tone
Material: Shockproof plastic
Relay: w/, E-approval: Yes

160632 Marine Air Horn

 Voltage: 24
Decibel: 117
Hertz: 228

Length: 500 mm

 Material: Stainless steel
Marine: Yes

160744 Compressor Horn

 Servicing: Boats until 12 m - Visit www.hc-cargo.com for further information

Electro pneumatic horn w/ integrated compressor.

 Voltage: 24
Decibel: 120
Hertz: 300

 Length:
120x190x120 mm

 Type: Single tone
Material: ASA plastic
Relay: w/, Marine: Yes

160756 Marine Air Horn

Approvals: Rina ELE/35398/2. Lloyds register MSA 9800031.

 Voltage: 24
Decibel: 123
Hertz: 630

 OD: 200 mm
Length: 460 mm

 Type: Single tone
Material: Enameled Brass
Marine: Yes

SPARE PARTS
160039 Electric Valve

For Compressor horn.

Voltage: 24

160213 Compressor

Marine horn: HC-CARGO 160048.



Voltage: 24

OD: 90 mm
Length: 165 mm
Pressure: 2 bar

Material: Aluminium
Relay: w/, Marine: Yes

160333 Compressor

Approved for boats until 12 mtr.



Servicing: HC-CARGO 160038

Voltage: 12

OD: 70 mm
Length: 112 mm
Pressure: 1.5 bar

Type: 1, 2 and 3 tones
Material: Aluminium
Relay: w/, Marine: Yes

160334 Compressor

Servicing: HC-CARGO 160038



Voltage: 24

OD: 70 mm
Length: 112 mm
Pressure: 1.5 bar

Type: 1, 2 and 3 tones
Material: Aluminium
Relay: w/, Marine: Yes

SPARE PARTS

160042 Y-Connector

Servicing: HC-CARGO 160002, 160508



190097 PA Hose 8 mm



ID: 8 mm
Length: 50 m
Temp.: -15°C - +60°C

POWER MANAGEMENT COMPONENTS

VOLTAGE CONVERTERS

160899 Adaptor

Max. output 220 W. 7-13 pole.



Voltage/in: 24
Voltage/out: 12
Watt/out: 6x70

Type: Switch mode

160900 Trailer Light Converter Adapter

Max. output 220 W. 7-7 pole.



Voltage/in: 24
Voltage/out: 12
Watt/out: 6x70

Type: Switch mode

160901 Trailer Light Converter

Output: 2x42 W + 4x60 W. Level B. To be used when HC-CARGO 160899 and 160900 are not suited.



Voltage/in: 24
Voltage/out: 12

Type: Switch mode/isolated
Protection degree: IP 69K

NON INSULATED

160387 Voltage Converter

The converter is supplied w/ a unique clip mounting bracket. The converter is intended for use w/ radios, cassette players or other similar equipment. Fitting instruction included.



Voltage/in: 24
Voltage/out: 13.8
Amp/5 min: 6
Amp/cont.: 3
Amp/ offload: 8
Watt/out: 40

Dim.: 68x87x50 mm

Type: Switch mode/uninsulated
Alarm/over heating: Yes
Alarm/overvoltage: Yes
Alarm/rev. con.: Yes
Alarm/transients: Yes
Over current: Yes
Approval: CE

160388 Voltage Converter

The converter is supplied w/ a unique clip mounting bracket. The converter is intended for use w/ radios, cassette players or other similar equipment. Fitting instruction included.



Voltage/in: 24
Voltage/out: 13.8
Amp/5 min: 10
Amp/cont.: 6
Amp/ offload: 8
Watt/out: 75

Dim.: 90x87x50 mm

Type: Switch mode non isolated
Alarm/over heating: Yes
Alarm/overvoltage: Yes
Alarm/rev. con.: Yes
Alarm/transients: Yes
Over current: Yes
Approval: CE

160306 Voltage Converter

The converter is supplied w/ a unique mounting bracket. The converter is intended for use w/ heavy duty communication equipment or other similar equipment. Fitting instruction included.



Voltage/in: 24
Voltage/out: 13.8
Amp/5 min: 18
Amp/cont.: 12
Amp/ offload: 8
Watt/out: 160

Dim.: 128x87x50 mm

Type: Switch mode/uninsulated
Alarm/over heating: Yes
Alarm/overvoltage: Yes
Alarm/rev. con.: Yes
Alarm/transients: Yes
Over current: Yes
Approval: CE

160389 Voltage Converter

The converter is supplied w/ a unique clip mounting bracket. The converter is intended for use w/ high power audio installations and high frequency radio transmission or other similar equipment. Fitting instruction included.



Voltage/in: 24
Voltage/out: 13.8
Amp/5 min: 30
Amp/cont.: 24
Amp/ offload: 8
Watt/out: 330

Dim.: 168x87x50 mm

Type: Switch mode/uninsulated
Alarm/over heating: Yes
Alarm/overvoltage: Yes
Alarm/rev. con.: Yes
Alarm/transients: Yes
Over current: Yes
Approval: CE

INSULATED
160960 Power Converter

Servicing: Used for mounting computers in trollies

Modified to stabilize the output voltage.

 Voltage/in: 10-32
 Voltage/out: 12
 Amp/cont.: 6
 Watt/out: 72

Dim.: 167x87x50 mm

 Type: Switch mode/isolated
 Approval: CE

160642 Converter

 Voltage/in: 12
 Voltage/out: 24
 Amp/5 min: 4
 Amp/cont.: 3
 Amp/ offload: <50
 Watt/out: 72

Dim.: 89x87x50 mm

 Type: Switch mode/isolated
 Over current: Yes
 Approval: CE

160644 Converter

 Voltage/in: 12
 Voltage/out: 24
 Amp/5 min: 9
 Amp/cont.: 7
 Amp/ offload: <50
 Watt/out: 168

Dim.: 167x87x50 mm

 Type: Switch mode/isolated
 Over current: Yes
 Approval: CE

160646 Converter

 Voltage/in: 12
 Voltage/out: 24
 Amp/5 min: 13
 Amp/cont.: 10
 Amp/ offload: <50
 Watt/out: 240

Dim.: 217x87x50 mm

 Type: Switch mode/isolated
 Over current: Yes
 Approval: CE

160390 Voltage Converter

The converter is supplied w/ a unique clip mounting bracket. The converter is intended for use w/ the same equipment as HC-CARGO 160387, but for systems where full isolation is required e.g. marine electrical systems and vehicles for petroche. Instruction included.

 Voltage/in: 24
 Voltage/out: 13.8
 Amp/5 min: 6
 Amp/cont.: 3
 Amp/ offload: 8
 Watt/out: 40

Dim.: 90x87x50 mm

 Type: Switch mode/isolated
 Alarm/over heating: Yes
 Alarm/overvoltage: Yes
 Alarm/rev. con.: Yes
 Alarm/transients: Yes
 Over current: Yes
 Approval: CE

160391 Voltage Converter

The converter is supplied w/ a unique clip mounting bracket. The converter is intended for use w/ the same equipment as HC-CARGO 160388, but for systems where full isolation is required e.g. marine electrical systems and vehicles for petroche. Instruction included.

 Voltage/in: 24
 Voltage/out: 13.8
 Amp/5 min: 10
 Amp/cont.: 6
 Amp/ offload: 8
 Watt/out: 75

Dim.: 128x87x50 mm

 Type: Switch mode/isolated
 Alarm/over heating: Yes
 Alarm/overvoltage: Yes
 Alarm/rev. con.: Yes
 Alarm/transients: Yes
 Over current: Yes
 Approval: CE

160392 Voltage Converter

The converter is supplied w/ a unique clip mounting bracket. The converter is intended for use w/ the same equipment as HC-CARGO 160306, but for systems where full isolation is required e.g. marine electrical systems and vehicles for petroche. Instruction included.



Voltage/in: 24
Voltage/out: 13.8
Amp/5 min: 18
Amp/cont.: 12
Amp/ offload: 8
Watt/out: 144

Dim.: 168x87x50 mm

Type: Switch mode/isolated
Alarm/over heating: Yes
Alarm/overvoltage: Yes
Alarm/rev. con.: Yes
Alarm/transients: Yes
Over current: Yes
Approval: CE

160640 Converter

Voltage/in: 24
Voltage/out: 12
Amp/5 min: 60
Amp/cont.: 50
Amp/ offload: <50
Watt/out: 600

Dim.: 300x100x80 mm

Type: Switch mode/isolated
Over current: Yes
Approval: CE

MULTI POWER
160579 Voltage Converter

Voltage/in: 36-90
Voltage/out: 12
Amp/cont.: 6
Watt/out: 75

Dim.: 134x94x18 mm

Protection degree: IP 68

160580 Voltage Converter

Voltage/in: 36-90
Voltage/out: 12
Amp/cont.: 15

Dim.: 134x94x48 mm

Protection degree: IP 68

RELAY BOXES
160167 Relay Box

Servicing: For 12 V trailer pulled by a 24 V vehicle - Visit www.hc-cargo.com for further information

Switches the voltage from 24 V to 12 V by 5 relays. Run at 24 V and leading 12 V from one of the batteries or converter to the lamps of the trailer. For continuous use it has to be connected via a converter. For internal mounting.



Voltage: 12/24
Amp: 10
Watt: 250

Dim.: 100x100x58 mm

No./poles: 7
Relay switch: Yes

160502 Trailer Connecting Unit

Servicing: For 12 V trailer pulled by a 24 V vehicle - Visit www.hc-cargo.com for further information

Mounted w/o use of converter.



Voltage: 12/24

Dim.: 110x103x43 mm

C2 control lamp: w/
No./poles: 7
Relay switch: No
Transistor switch: Yes
Waterproof: Yes
IP rating: IP 65

160797 Relay Box

To reduce voltage drop, if you use vehicles w/ trailer. Fitted w/ 5x12 V relays the 12 V function will not be affected.



Voltage: 12-12
Amp: 5x8
Watt: 5x250

Dim.: 100x100x58 mm

VOLTAGE INVERTERS
160543 Voltage Inverter

Voltage/in: 10-15
Voltage/out: 230
Alarm/Voltage:
10.5±0.5
Shut down/Voltage:
10±0.5
Amp/max/cont.:
<35
Amp/standby: <0.3
Watt/cont.: 300
Watt/max.: 1000

Dim.: 190x91x58 mm
Weight: 1.1 kg
Temp.: 60°C±5°C
Regulation: ±10
Efficiency: Over 90 %

Type: Modified sine
Over heating: Yes
Overloading: Yes
Short circuit: Yes
Approval: CE

160545 Voltage Inverter

Voltage/in: 10-15
Voltage/out: 230
Alarm/Voltage:
10.5±0.5
Shut down/Voltage:
10±0.5
Amp/ standby: <0.3
Watt/cont.: 600
Watt/max.: 1500

Dim.: 242x91x58 mm
Weight: 1.7 kg
Temp.: 60°C±5°C
Regulation: ±10

Type: Modified sine
Over heating: Yes
Overloading: Yes
Short circuit: Yes
Approval: CE

160569UK Voltage Inverter

Voltage/in: 10-15
Voltage/out: 230
Alarm/Voltage:
10.5±0.5
Shut down/Voltage:
10±0.5
Amp/standby: 1
Watt/cont.: 1500
Watt/max.: 3500

Dim.: 395x240x90 mm
Weight: 5.5 kg
Temp.: 60°C±5°C

Type: Modified sine
Over heating: Yes
Overloading: Yes
Short circuit: Yes
Approval: CE

160660 Voltage Inverter

Voltage/in: 10-15
Voltage/out: 230
Alarm/Voltage:
10.5±0.5
Shut down/Voltage:
10±0.5
Amp/ standby: <0.8
Watt/cont.: 1000
Watt/max.: 2500

Dim.: 310x205x75 mm
Weight: 5 kg
Temp.: 60°C±5°C
Regulation: ±10

Type: Modified sine
Over heating: Yes
Overloading: Yes
Short circuit: Yes
Approval: CE

160541 Voltage Inverter

Voltage/in: 12
Voltage/out: 230
Alarm/Voltage:
10.5±0.5
Shut down/Voltage:
10±0.5
Amp/max/cont.:
<20
Amp/standby: <0.3
Watt/cont.: 150
Watt/max.: 450

Dim.: 165x91x58 mm
Weight: 0.850 kg
Temp.: 60°C±5°C
Regulation: ±10
Efficiency: Over 90 %

Type: Modified sine
Over heating: Yes
Overloading: Yes
Short circuit: Yes
Approval: CE

	EL. SPECIFICATIONS	DIMENSIONS	ADDITIONAL SPECIFICATIONS
160545UK Voltage Inverter 	Voltage/in: 12 Voltage/out: 230 Alarm/Voltage: 10.5±0.5 Shut down/Voltage: 10±0.5 Amp/standby: <1.35 Watt/cont.: 600 Watt/max.: 1500	Dim.: 242x91x58 mm Weight: 1.7 kg Temp.: 60°C±5°C Regulation: ±10	Type: Modified sine Over heating: Yes Overloading: Yes Short circuit: Yes Approval: CE
160569 Voltage Inverter 	Voltage/in: 12 Voltage/out: 230 Alarm/Voltage: 10.5±0.5 Shut down/Voltage: 10±0.5 Amp/standby: <2 Watt/cont.: 1500 Watt/max.: 3500	Dim.: 395x240x90 mm Weight: 5.5 kg Temp.: 60°C±5°C	Type: Modified sine Cooling fan: Yes Over heating: Yes Overloading: Yes Short circuit: Yes Approval: CE
160660UK Voltage Inverter 	Voltage/in: 12 Voltage/out: 230 Alarm/Voltage: 10.5±0.5 Shut down/Voltage: 10±0.5 Amp/ standby: <0.3 Watt/cont.: 1000 Watt/max.: 2500	Dim.: 310x205x75 mm Weight: 5 kg Temp.: 60°C±5°C Regulation: ±10	Type: Modified sine Over heating: Yes Overloading: Yes Short circuit: Yes Approval: CE
160581UK Voltage Inverter 	Voltage/in: 20-30 Voltage/out: 230 Alarm/Voltage: 21±1 Shut down/Voltage: 20±1 Amp/standby: <1 Watt/cont.: 1500 Watt/max.: 3500	Dim.: 395x240x90 mm Weight: 5.5 kg Temp.: 60°C±5°C	Type: Modified sine Over heating: Yes Overloading: Yes Short circuit: Yes Approval: CE
160542 Voltage Inverter 	Voltage/in: 24 Voltage/out: 230 Alarm/Voltage: 21±1 Shut down/Voltage: 20±1 Amp/max/cont.: <10 Amp/standby: <0.3 Watt/cont.: 150 Watt/max.: 450	Dim.: 165x91x58 mm Weight: 0.850 kg Temp.: 60°C±5°C Regulation: ±10 Efficiency: Over 90 %	Type: Modified sine Over heating: Yes Overloading: Yes Short circuit: Yes Approval: CE
160544 Voltage Inverter 	Voltage/in: 24 Voltage/out: 230 Alarm/Voltage: 21±1 Shut down/Voltage: 20±1 Amp/max/cont.: <20 Amp/standby: <0.3 Watt/cont.: 300 Watt/max.: 1000	Dim.: 190x91x58 mm Weight: 1.1 kg Temp.: 60°C±5°C Regulation: ±10	Type: Modified sine Over heating: Yes Overloading: Yes Short circuit: Yes Approval: CE
160546 Voltage Inverter 	Voltage/in: 24 Voltage/out: 230 Alarm/Voltage: 21±1 Shut down/Voltage: 20±1 Amp/ standby: <0.3 Watt/cont.: 600 Watt/max.: 1500	Dim.: 242x91x58 mm Weight: 1.7 kg Temp.: 60°C±5°C Regulation: ±10	Type: Modified sine Over heating: Yes Overloading: Yes Short circuit: Yes Approval: CE

	EL. SPECIFICATIONS	DIMENSIONS	ADDITIONAL SPECIFICATIONS
160581 Voltage Inverter 	Voltage/in: 24 Voltage/out: 230 Alarm/Voltage: 21±1 Shut down/Voltage: 20±1 Amp/standby: <1 Watt/cont.: 1500 Watt/max.: 3500	Dim.: 395x240x90 mm Weight: 5.5 kg Temp.: 60°C±5°C	Type: Modified sine Over heating: Yes Overloading: Yes Short circuit: Yes Approval: CE
160676 Voltage Inverter 	Voltage/in: 24 Voltage/out: 230 Alarm/Voltage: 21±1 Shut down/Voltage: 20±1 Amp/ standby: <0.8 Watt/cont.: 1000 Watt/max.: 2500	Dim.: 310x205x75 mm Weight: 5 kg Temp.: 60°C±5°C Regulation: ±10	Type: Modified sine Over heating: Yes Overloading: Yes Short circuit: Yes Approval: CE
160676UK Voltage Inverter 	Voltage/in: 24 Voltage/out: 230 Alarm/Voltage: 21±1 Shut down/Voltage: 20±1 Amp/ standby: <0.8 Watt/cont.: 1000 Watt/max.: 2500	Dim.: 310x205x75 mm Weight: 5 kg Temp.: 60°C±5°C Regulation: ±10	Type: Modified sine Over heating: Yes Overloading: Yes Short circuit: Yes Approval: CE
160991 Voltage Inverter AC-DC 	Servicing: HC-CARGO 804114 Voltage/in: 230 Voltage/out: 12V DC Amp/max/cont.: 25	Dim.: 226.5x115x49.7 mm Temp.: 85°C±5°C	Type: AC-DC Over heating: Yes Overloading: Yes Short circuit: Yes Approval: CE
<h2>VOLTAGE REDUCER</h2>			
160627 Voltage Reducer Set w/ 2 resistors. Reduces the voltage w/ 0.75 V. Secures the lifetime of the headlight bulbs in cars w/ high voltage. 12/24 V. 			
<h2>LOAD RESISTORS</h2>			
160970 Load Resistor 12 V 	Voltage: 12 Amp: 2 Ohm: 6 Watt: 50	Length: 50 mm Width: 15 mm	
160971 Load Resistor 24 V 	Voltage: 24 Amp: 1 Ohm: 24 Watt: 50	Length: 50 mm Width: 15 mm	

CHARGERS

160874 Charger



Voltage: 23/24
Amp: 12

Dim.: 235x87x58 mm
Weight: 1.660 kg
Working temp.:
-30°C±55°C

Warning lamp: w/
Auto stop: Yes
Approval: CE
Protection degree: IP 67

160875 Charger



Voltage: 230/12
Amp: 17

Dim.: 235x87x58 mm
Weight: 1.660 kg
Working temp.:
-30°C±55°C

Warning lamp: w/
Auto stop: Yes
Approval: CE
Protection degree: IP 67

160968 Charger

Charger cable: HC-CARGO 160990.



Voltage: 230/12
Amp: 3

Dim.: 160x96x54 mm
Weight: 0.85 kg
Working temp.:
-20°C±50°C

Warning lamp: w/
Approval: CE
Hertz: 50
Protection degree: IP 65

160969 Charger 5 A

Charger cable: HC-CARGO 160990.



Voltage: 230/12
Amp: 5

Dim.: 160x96x54 mm
Weight: 0.85 kg
Working temp.:
-20°C±50°C

Warning lamp: w/
Approval: CE
Hertz: 50
Protection degree: IP 65

ACCESSORIES

160990 Charger cable

Servicing: HC-CARGO 160968, 160969, 160968UK, 160969UK



Voltage: 300

Rolls size: 0.3 m
Temp. area: 60 °C

Lead type: Dual
Cap colour: Black
Cap material: PVC

POWER GUARD

161014 Power Guard



Voltage/in: 9-32
Alarm/Voltage: Yes
Shut down/Voltage: Yes
Shut down/12 V: 11.5 V
Shut down/24 V: 23 V
Amp max/cont.: 10

Dim.: 155x30x15 mm
Weight: 0.045 kg
Regulation: Yes

Connection: Connection
Over heating: Yes
Overloading: Yes
Short circuit: Yes

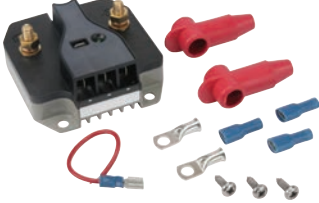
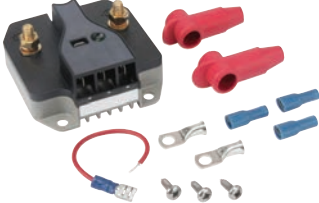
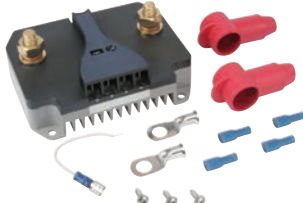
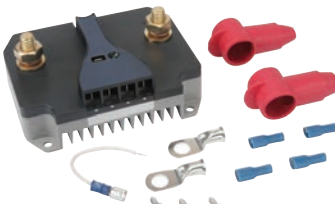
	EL. SPECIFICATIONS	DIMENSIONS	ADDITIONAL SPECIFICATIONS
161015 Power Guard 	Voltage/in: 9-32 Alarm/Voltage: Yes Shut down/Voltage: Yes Shut down/12 V: 11.5 V Shut down/24 V: 23 V Amp max/cont.: 20	Dim.: 155x30x15 mm Weight: 0.045 kg Regulation: Yes	Connection: Connection Over heating: Yes Overloading: Yes Short circuit: Yes
161016 Power Guard 	Voltage/in: 9-32 Alarm/Voltage: Yes Shut down/Voltage: Yes Shut down/12 V: 11.5 V Shut down/24 V: 23 V Amp max/cont.: 40	Dim.: 76x78x33 mm Weight: 0.155 kg Regulation: Yes	Connection: M6 Over heating: Yes Overloading: Yes Short circuit: Yes
161017 Power Guard 	Voltage/in: 9-32 Alarm/Voltage: Yes Shut down/Voltage: Yes Shut down/12 V: 11.5 V Shut down/24 V: 23 V Amp max/cont.: 60	Dim.: 76x78x33 mm Weight: 0.155 kg Regulation: Yes	Connection: M6 Over heating: Yes Overloading: Yes Short circuit: Yes
161018 Power Guard 	Voltage/in: 9-32 Alarm/Voltage: Yes Shut down/Voltage: Yes Shut down/12 V: 11.5 V Shut down/24 V: 23 V Amp max/cont.: 100	Dim.: 124x97x51 mm Weight: 0.530 kg Regulation: Yes	Connection: M10 Over heating: Yes Overloading: Yes Short circuit: Yes
161019 Power Guard 	Voltage/in: 9-32 Alarm/Voltage: Yes Shut down/Voltage: Yes Shut down/12 V: 11.5 V Shut down/24 V: 23 V Amp max/cont.: 200	Dim.: 124x97x51 mm Weight: 0.530 kg Regulation: Yes	Connection: M10 Over heating: Yes Overloading: Yes Short circuit: Yes

BATTERY ISOLATORS

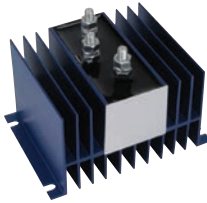
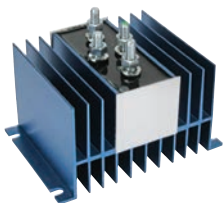
160342 Battery Isolator 	Servicing: Boats, autocampers, industrial vehicles - Visit www.hc-cargo.com for further information Eliminates the multi battery drain when 2 or more batteries are in a charging system.	Voltage: 6-36 Current/max Amp: 70	Dim.: 85x115x95 mm No./batteries: 2 Comp. diode: No
160343 Battery Isolator 	Servicing: Boats, autocampers, industrial vehicles - Visit www.hc-cargo.com for further information Eliminates the multi battery drain when 2 or more batteries are in a charging system. w/ compensations diode which allows a higher charging current.	Voltage: 6-36 Current/max Amp: 70	Dim.: 85x115x95 mm No./batteries: 2 Comp. diode: Yes

160398 Battery Isolator

 Servicing: Boats, autocampers, industrial vehicles - Visit www.hc-cargo.com for further information

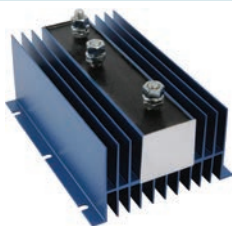
Eliminates the multi battery drain when 2 or more batteries are in a charging system.

 Voltage: 6-36
Current/max Amp:
120

Dim.: 170x115x95 mm

 No./batteries: 2
Comp. diode: No

160399 Battery Isolator

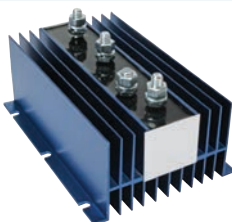
 Servicing: Boats, autocampers, industrial vehicles - Visit www.hc-cargo.com for further information

Eliminates the multi battery drain when 2 or more batteries are in a charging system. w/ compensations diode which allows a higher charging current.

 Voltage: 6-36
Current/max Amp:
120

Dim.: 170x115x95 mm

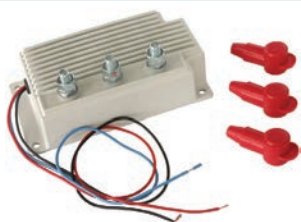
 No./batteries: 2
Comp. diode: Yes

160735 Battery Isolator
This cut-off relays, separates from others because it especially can be used on models which need power at B+ to start up the generator load. When connecting additional contact may also be used to boost the starting battery. 0-volt drop. E-market. Waterproof.

 Voltage: 12/24
Current/max Amp:
150

Dim.: 155x80x41 mm

 No./batteries: 2
Approval: CE

160740 Split Charge Relay

 Servicing: Boats, autocampers, industrial vehicles - Visit www.hc-cargo.com for further information

Microprocessor controlled relay. Allows charging on the auxiliary battery at 13.4 V charging voltage.

 Voltage: 12
Current/max Amp:
180

Dim.: 120x80x55 mm

 No./batteries: 2
Comp. diode: No

160742 Split Charge Relay

 Servicing: Boats, autocampers, industrial vehicles - Visit www.hc-cargo.com for further information

Microprocessor controlled relay. Allows charging on the auxiliary battery at 27 V charging voltage.

 Voltage: 24
Current/max Amp:
100

Dim.: 120x80x70 mm

 No./batteries: 2
Comp. diode: No

160876 Split Charge Relay

13.4 V-12.6 V.

 Voltage: 12
Current/max Amp:
70

Dim.: 60x34x70 mm

 No./batteries: 2
Comp. diode: No

	EL. SPECIFICATIONS	DIMENSIONS	ADDITIONAL SPECIFICATIONS
160877 Split Charge Relay 	Voltage: 24 Current/max Amp: 50	Dim.: 60x34x70 mm	No./batteries: 2 Comp. diode: No
SWITCHES BATTERY SWITCHES			
180028 Battery Main Switch <i>Spare key: HC-CARGO 180143, 180619, 181270. Pole: dia. 10 mm.</i>			
	Voltage: 24 Amp/5 sec.: 500 Amp/cont.: 100	Dist. mount. holes: 38 mm	Type: Battery Material: Plastic No./mounting holes: 2 Key: w/ Protection degree: IP 65
180087 Battery Main Switch <i>Spare key: HC-CARGO 180202.</i>			
	Voltage: 24 Amp/5 sec.: 2500 Amp/cont.: 250	Dist. mount. holes: 100 mm	Type: Battery Material: Metal No./mounting holes: 2 Key: w/ Protection degree: IP 66
180203 Battery Main Switch <i>Spare key: HC-CARGO 180029, 180619.</i>			
	Voltage: 24 Amp/5 sec.: 2500 Amp/cont.: 250	Dist. mount. holes: 100 mm	Type: Battery Material: Plastic No./mounting holes: 2 No./poles: 2 Key: w/ Protection degree: IP 66
180211 Battery Main Switch <i>Spare key: HC-CARGO 180288 or 180333. Rubber boot: HC-CARGO 180375.</i>			
	Voltage: 24 Amp/5 sec.: 2500 Amp/cont.: 250	Dist. mount. holes: 100 mm	Type: Battery Material: Metal No./mounting holes: 2 Key: w/ Protection degree: IP 65
180216 Battery Main Switch <i>Spare key: HC-CARGO 180143, 180619, 181270. Rubber protection cap: HC-CARGO 180374.</i>			
	Voltage: 24 Amp/5 sec.: 500 Amp/cont.: 100	Dist. mount. holes: 39.5 mm	Type: Battery Material: Plastic No./mounting holes: 2 Key: w/ Protection degree: IP 40

180229 Battery Main Switch

Spare key: HC-CARGO 180029, 180619, 181270. On / Off under load



Voltage: 24
Amp/5 sec.: 2500
Amp/cont.: 250

Dist. mount. holes:
100 mm

Type: Battery
Material: Plastic
No./mounting holes: 2
Key: w/
Protection degree: IP 66

180271 Battery Main Switch

Rubber boot: HC-CARGO 180375. Working temp. -30°C/+65°C.



Voltage: 12/24
Amp/5 sec.: 1000
Amp/cont.: 300

Dist. mount. holes:
45 mm

Type: Battery
Material: Plastic
Explosion proof 1: Yes
No./mounting holes: 2
No./poles: M10
Key: w/
Waterproof: Yes
Protection degree: IP 65
Approval: SAE J1171

180276 Battery Main Switch

Rubber boot: HC-CARGO 180375. For alternator w/ intergral regulator. w/ D+ contact.



Voltage: 24
Amp/5 sec.: 2500
Amp/cont.: 250

Dist. mount. holes:
110 mm

Type: Battery
Material: Plastic
Explosion proof 1: Yes
Explosion proof 2: Yes
No./mounting holes: 2
No./poles: 2
Key: w/
Waterproof: Yes
Protection degree: IP 67
Approval: ADR

180289 Battery Main Switch

Rubber boot: HC-CARGO 180375.



Voltage: 24
Amp/5 sec.: 2500
Amp/cont.: 250

Dist. mount. holes:
M30 mm

Type: Battery
Material: Metal
No./mounting holes: 2
Key: w/
Protection degree: IP 65

180313 Battery Main Switch

Spare key: HC-CARGO 180143, 181270. Rubber protection cap: HC-CARGO 180374.



Voltage: 24
Amp/5 sec.: 500
Amp/cont.: 100

Dist. mount. holes:
45 mm

Type: Battery
No./mounting holes: 2
Key: w/o
Protection degree: IP 40

180326 Battery Main Switch

Rubber boot: HC-CARGO 180375. w/ rotation/press handle.



Voltage: 24
Amp/5 sec.: 2500
Amp/cont.: 250

Dist. mount. holes:
100 mm

Type: Battery
No./mounting holes: 2
Protection degree: IP 65

180596 Battery Main Switch
Spare key: HC-CARGO 180029, 180619.

 Voltage: 24
 Amp/5 sec.: 500
 Amp/cont.: 100

 Dist. mount. holes:
 38 mm

 Type: Battery
 Material: Plastic
 No./mounting holes: 2
 Key: w/
 Resistor: 3 Ohm, 11 W
 Sec. circuit: w/
 Protection degree: IP 43

180614 Battery Main Switch
Spare key: HC-CARGO 181578.

 Voltage: 24
 Amp/5 sec.: 1000
 Amp/cont.: 75

 Dist. mount. holes:
 38 mm

 Type: Battery
 Material: Metal
 No./mounting holes: 2
 Key: w/
 Protection degree: IP 41

181238 Battery Main Switch
Spare key: HC-CARGO 180333. Rubber boot: HC-CARGO 180375.

 Voltage: 24
 Amp/5 sec.: 2500
 Amp/cont.: 250

 Dist. mount. holes:
 100 mm

 Type: Battery
 Material: Metal
 No./mounting holes: 2
 Key: w/
 Waterproof: Yes
 Protection degree: IP 66

181475 Battery Main Switch
Spare key: HC-CARGO 180288, w/o chain and rubber cap. Rubber boot: HC-CARGO 180375.

 Voltage: 24
 Amp/5 sec.: 2500
 Amp/cont.: 250

 Dist. mount. holes:
 100 mm

 Material: Metal
 No./mounting holes: 2
 Key: w/
 Protection degree: IP 65

181599 Battery Main Switch
Rubber boot: HC-CARGO 180375.

 Voltage: 12-24
 Amp/5 sec.: 2500
 Amp/cont.: 250

 Dist. mount. holes:
 120 mm

 Type: Battery
 Material: Metal
 No./mounting holes: 2
 No./poles: 4
 Key: w/
 Waterproof: Yes
 Protection degree: IP 66

181613 Battery Main Switch

 Voltage: 12-50
 Amp/5 sec.: 1000
 Amp/cont.: 200

 Dist. mount. holes:
 104 mm

 Type: Battery
 Material: PBT
 No./mounting holes: 3
 No./poles: 3
 Key: w/o
 Protection degree: IP 54
 Approval: CE

181614 Battery Main Switch

Voltage: 12-50
Amp/5 sec.: 1000
Amp/cont.: 200

Dist. mount. holes:
55 mm

Type: Battery
Material: PBT
No./mounting holes: 4
No./poles: 2
Key: w/
Protection degree: IP 54
Approval: CE

WATERPROOF
180272 Battery Main Switch

Servicing: Marine - Visit www.hc-cargo.com for further information

Spare key: HC-CARGO 180333. Rubber boot: HC-CARGO 180375.



Voltage: 24
Amp/5 sec.: 1000
Amp/cont.: 150

Dist. mount. holes:
45 mm

Type: Battery
Material: Metal
Explosion proof 1: Yes
No./mounting holes: 2
Key: w/
Waterproof: Yes
Protection degree: IP 67

180274 Battery Main Switch

Rubber boot: HC-CARGO 180375 . For alternator w/ separate regulator.



Voltage: 24
Amp/5 sec.: 2500
Amp/cont.: 250

Dist. mount. holes:
65 mm

Type: Battery
Material: Plastic
Explosion proof 1: Yes
No./mounting holes: 2
Key: w/
Waterproof: Yes
Protection degree: IP 67

180275 Battery Main Switch

Rubber boot: HC-CARGO 180375. For alternator w/ intergral regulator. w/ D+ contact.



Voltage: 24
Amp/5 sec.: 2500
Amp/cont.: 250

Dist. mount. holes:
65 mm

Type: Battery
Material: Plastic
Explosion proof 1: Yes
No./mounting holes: 2
Key: w/
Waterproof: Yes
Protection degree: IP 67

180277 Battery Main Switch

Rubber boot: HC-CARGO 180375 . For alternator w/ separate regulator.



Voltage: 24
Amp/5 sec.: 2500
Amp/cont.: 250

Dist. mount. holes:
110 mm

Type: Battery
Material: Plastic
Explosion proof 1: Yes
Explosion proof 2: Yes
No./mounting holes: 2
No./poles: 2
Key: w/
Waterproof: Yes
Protection degree: IP 67

180278 Battery Main Switch

Spare key: HC-CARGO 181477. Rubber boot: HC-CARGO 180375.



Voltage: 24
Amp/5 sec.: 3000
Amp/cont.: 300

Dist. mount. holes:
100 mm

Type: Battery
Material: Metal
Explosion proof 1: Yes
No./mounting holes: 2
Key: w/
Waterproof: Yes
Protection degree: IP 67

180338 Battery Main Switch

For alternator w/ separate regulator. w/ secondary circuit 24 V. Rubber boot: HC-CARGO 180375.



Voltage: 24
Amp/5 sec.: 2500
Amp/cont.: 20

Dist. mount. holes:
65 mm

Type: Battery
Material: Plastic
Explosion proof 1: Yes
No./mounting holes: 2
Key: w/
Sec. circuit: w/
Waterproof: Yes
Protection degree: IP 67

REMOTE CONTROL

180280 Pneumatic Remote Control

Servicing: HC-CARGO 180279, 180291



RUBBER BOOTS

180374 Terminal Boot

Servicing: HC-CARGO 180216, 180313



Material: Rubber

180375 Terminal Boot set

Servicing: HC-CARGO 180211, 180271, 180272, 180274, 180275, 180276, 180277, 180278, 180289, 180326, 180338, 180238

Supplied in kit of 2 pcs.



Material: Rubber

SPARE KEYS

180029 Key

Servicing: HC-CARGO 180028, 180203, 180216, 180229, 180313, 180596











No./pins: 2

180143 Key

Servicing: HC-CARGO 180028, 180216, 180313



	EL. SPECIFICATIONS	DIMENSIONS	ADDITIONAL SPECIFICATIONS
180202 Key	Servicing: HC-CARGO 180087		
			
180273 Key	Servicing: HC-CARGO 180272		
			
180288 Key	Servicing: HC-CARGO 180211, 180288		No./pins: 2
			
180333 Key	Servicing: HC-CARGO 180211, 181238		No./pins: 1
			
180619 Key	Servicing: HC-CARGO 180028, 180203, 180216, 180229, 180596		No./pins: 1
			
181270 Key	Servicing: HC-CARGO 180028, 180216, 180229, 180313		No./pins: 1
			
181477 Key	Servicing: HC-CARGO 180278		
			
181578 Key	Servicing: HC-CARGO 180614		
<i>For battery main switch.</i>			
			

181603 Key

Servicing: HC-CARGO 181599

For battery main switch.



ELECTROMAGNETIC

180232 Battery Switch

Servicing: Industrial vehicles, buses, tractors, lift trucks and boats - Visit www.hc-cargo.com for further information

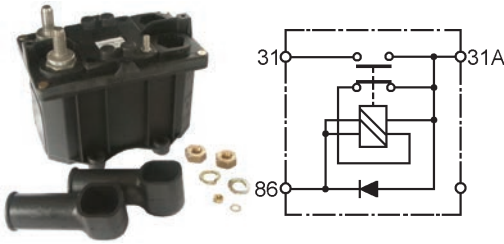

Voltage: 12
Amp/5 sec.: 2500
Amp/cont.: 250

Type: Electromagnetic
Switch: Negative

180233 Battery Switch

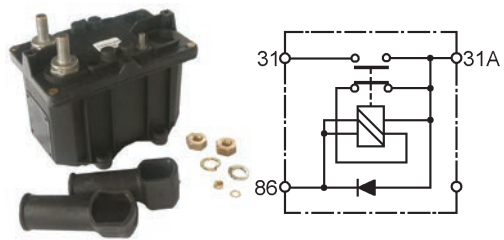

Voltage: 24
Amp/5 sec.: 2500
Amp/cont.: 250

Type: Electromagnetic
Switch: Negative

180290 Battery Switch Relay

For serial and parallel conncion of two 12 V batteries in 12 V systems w/ 24 V starter.



Voltage: 12/24
Amp/5 sec.: 1500
(1 sec)
Amp/cont.: 75

180556 Battery Switch

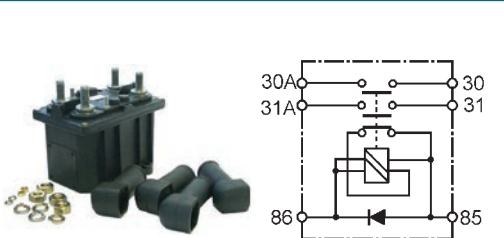

Voltage: 24
Amp/5 sec.: 2500
Amp/cont.: 250

Type: Electromagnetic
Switch: Positive/Negative

180602 Battery Switch

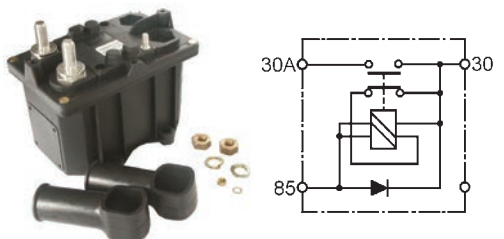

Voltage: 12
Amp/5 sec.: 2500
Amp/cont.: 250

Type: Electromagnetic
Switch: Positive

180603 Battery Switch

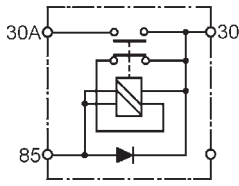

Voltage: 24
Amp/5 sec.: 2500
Amp/cont.: 200

Type: Electromagnetic
Switch: Positive

180604 Battery Switch

w/ separate power supply.

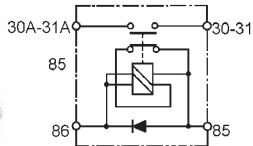

Voltage: 12
Amp/5 sec.: 2500
Amp/cont.: 250

Type: Electromagnetic
Switch: Positive/Negative

180605 Battery Switch

w/ separate power supply.

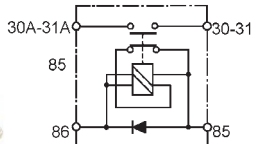

Voltage: 24
Amp/5 sec.: 2500
Amp/cont.: 200

Type: Electromagnetic
Switch: Positive/Negative

181476 Battery Switch

Plug: HC-CARGO 181545.

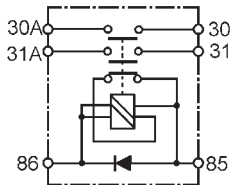

Voltage: 24
Amp/5 sec.: 2500
Amp/cont.: 250

Type: Electromagnetic
Explosion proof 1: Yes
Explosion proof 2: Yes
Switch: Positive/Negative
No./mounting holes: 4
No./poles: 4
Approval: Ex

181562 Battery Switch

w/ separate power supply.

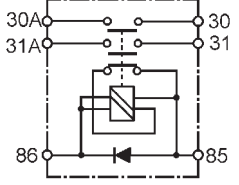

Voltage: 12
Amp/5 sec.: 2500
Amp/cont.: 250

Switch: Positive/Negative

EMERGENCY STOP SWITCHES

181247 Emergency Stop Button

Emergency stop button operable w/ push button, turn for reset.



Protection degree: IP 65

181271 Emergency Stop Button

Emergency stop button operable w/ push button, turn for reset.



Protection degree: IP 66

CONTROL BOXES

181244 Control Box



Voltage/AC 1: 220
 Voltage/DC 1: 24
 Voltage/AC 2: 380
 Voltage/DC 2: 48
 Voltage/AC 3: 500
 Voltage/DC 3: 100
 Amp/max 1: 5
 Amp/max 2: 4.5
 Amp/max 3: 4
 Amp/max 4: 3
 Amp/max 5: 2

Buttons: 2
 Protection degree: IP 65

181245 Control Box



Voltage/AC 1: 220
 Voltage/DC 1: 24
 Voltage/AC 2: 380
 Voltage/DC 2: 48
 Voltage/AC 3: 500
 Voltage/DC 3: 100
 Amp/max 1: 5
 Amp/max 2: 4.5
 Amp/max 3: 4
 Amp/max 4: 3
 Amp/max 5: 2

Buttons: 3
 Protection degree: IP 65

181246 Control Box



Voltage/AC 1: 220
 Voltage/DC 1: 24
 Voltage/AC 2: 380
 Voltage/DC 2: 48
 Voltage/AC 3: 500
 Voltage/DC 3: 100
 Amp/max 1: 5
 Amp/max 2: 4.5
 Amp/max 3: 4
 Amp/max 4: 3
 Amp/max 5: 2

Buttons: 2
 Protection degree: IP 65

181540 Remote Lift Control Set

Servicing: Lift, doors, ports, winches, hoists etc - Visit www.hc-cargo.com for further information

Set of hand transmitter, receiver and antenna. Individual coding. Coverage 50-125 m. w/o emergency stop.



Voltage/AC 1: 12
 Voltage/DC 1: 12
 Voltage/AC 2: 24
 Voltage/DC 2: 24

Buttons: 3
 Protection degree: IP 65

181577 Control Box

For tail lift.



Voltage/DC 1:
 12-24

Buttons: 3
 Protection degree: IP 65

IGNITION/LIGHT

180045 Ignition/Light Switch

Spare key: HC-CARGO 180341.



Mount. hole size:
26.5 mm

Switch combination: Parkinglight-off-
ignition-sidelight-DRL
No./keys: 2
Terminals: 6

180324 Ignition/Light Switch

Spare key: HC-CARGO 180341.



Mount. hole size:
26.5 mm

Switch combination: Parkinglight-off-
ignition-sidelight-DRL
No./keys: 2
Terminals: 7

IGNITION STARTER

180025 Ignition Starter Switch

Spare key: HC-CARGO 180339.



Mount. hole size:
18.5 mm

Switch combination: Off-Start
No./keys: 2
Terminals: 3

180027 Ignition Starter Switch

Spare key: HC-CARGO 180339. Multiplug: HC-CARGO 181597.



Mount. hole size:
18.5 mm

Switch combination: Off-ignition-start
No./keys: 2
Terminals: 5

180041 Ignition Starter Switch

Spare key: HC-CARGO 180340.



Mount. hole size:
26.5 mm

Switch combination: Parking light-off-
start
No./keys: 2
Terminals: 7
Protection degree: IP 63
DIN norm: 40050

180043 Ignition Starter Switch

Spare key: HC-CARGO 180339.



Mount. hole size:
18.5 mm

Switch combination: Off-aux-ignition-
start
No./keys: 2
Terminals: 4

181518 Ignition Starter Switch

Spare key: HC-CARGO 180339.



Mount. hole size:
22.5 mm

Switch combination: Off-ignition-start
No./keys: 2
Terminals: 5
Positions: 1 (start)

DIESEL STARTER

180044 Ignition Switch

Servicing: Deutz, IH

Supplied w/ 2 keys. Spare key: HC-CARGO 180340. Multiplug: HC-CARGO 181595, 181596.



Mount. hole size:
26.5 mm

Switch combination: Parking light-off-ignition-glow-start
Terminals: 10
Protection degree: IP 63
DIN norm: 40050

181235 Ignition Switch

Servicing: Massey Ferguson - Visit www.hc-cargo.com for further information

Spare key: HC-CARGO 181465.



Mount. hole size:
16 mm

Switch combination: Off-ignition-glow-start
No./keys: 2
Terminals: 6
Positions: 4

181236 Ignition Switch

Servicing: Massey Ferguson - Visit www.hc-cargo.com for further information

Spare key: HC-CARGO 181465.



Mount. hole size:
16 mm

Switch combination: Off-ignition-start
No./keys: 2
Terminals: 4
Positions: 4

181237 Ignition Switch

Servicing: Massey Ferguson - Visit www.hc-cargo.com for further information

Spare key: HC-CARGO 181465.



Mount. hole size:
16 mm

Switch combination: Off-aux-ignition-glow-start
No./keys: 2
Terminals: 7
Positions: 5

RUBBER BOOTS

181598 Rubber Boot

Servicing: HC-CARGO 180044



SPARE PARTS
180339 Spare Key

Servicing: HC-CARGO 180025, 180027, 180043, 181518

180340 Spare Key

Servicing: HC-CARGO 180041, 180044

180341 Spare Key

Servicing: HC-CARGO 180045, 180324

181465 Spare Key

Servicing: HC-CARGO 181235, 181236, 181237



Material: Metal

181595 Central Plug Connector

Servicing: HC-CARGO 180044

DIN 46340. Used w/ HC-CARGO 181596.

 Type: Socket
 Type/terminal: 9.5x1.2
 Colour: Black
 No./poles: 4
 Plug: Female

181596 Central Plug Connector

Servicing: HC-CARGO 180044

DIN 46340. Used w/ HC-CARGO 181595.

 Type: Socket
 Type/terminal: 6.3x0.8
 Colour: Black
 No./poles: 6
 Plug: Female

181597 Central Plug Connector

Servicing: HC-CARGO 180027

 Type: Socket
 Colour: Black
 No./poles: 6
 Plug: Female

SOLENOIDS

SOLENOID SHUTDOWN-KITS

EXTERNALLY SWITCHED

090095 Solenoid Shutdown Kit

This solenoid can't switch off by itself, it will have to be controlled externally.



Voltage: 12
Amp/hold: 1.1
Amp/pull: 46

Pull rating: 89N at
25.40 mm
Mount. side: Left
Hold rating: 178N

Elect. connection: Cable
Function: Pull
Mount. type: Flange/bracket
Switch: External

090096 Solenoid Shutdown Kit

This solenoid can't switch off by itself, it will have to be controlled externally.



Voltage: 12
Amp/hold: 1.1
Amp/pull: 46

Pull rating: 89N at
25.40 mm
Mount. side: Right
Hold rating: 178N

Elect. connection: Cable
Function: Pull
Mount. type: Flange/bracket
Switch: External

090099 Solenoid Shutdown Kit

This solenoid can't switch off by itself, it will have to be controlled externally.



Voltage: 24
Amp/hold: 0.5
Amp/pull: 25

Pull rating: 89N at
25.40 mm
Mount. side: Left
Hold rating: 178N

Elect. connection: Cable
Function: Pull
Mount. type: Flange/bracket
Switch: External

090100 Solenoid Shutdown Kit

This solenoid can't switch off by itself, it will have to be controlled externally.



Voltage: 24
Amp/hold: 0.5
Amp/pull: 25

Pull rating: 89N at
25.40 mm
Mount. side: Right
Hold rating: 178N

Elect. connection: Cable
Function: Pull
Mount. type: Flange/bracket
Switch: External

090103 Solenoid Shutdown Kit

Servicing: Nippondenso, Zexel - Visit www.hc-cargo.com for further information

This solenoid can't switch off by itself, it will have to be controlled externally.



Voltage: 12
Amp/hold: 1.1
Amp/pull: 55

Pull rating: 89N at
25.40 mm
Mount. side: Left
Hold rating: 178N

Elect. connection: Cable
Function: Pull
Mount. type: Flange/bracket
Switch: External

090104 Solenoid Shutdown Kit

Servicing: Nippondenso, Zexel - Visit www.hc-cargo.com for further information

This solenoid can't switch off by itself, it will have to be controlled externally.



Voltage: 12
Amp/hold: 1.1
Amp/pull: 55

Pull rating: 89N at
25.40 mm
Mount. side: Right
Hold rating: 178N

Elect. connection: Cable
Function: Pull
Switch: External

090105 Solenoid Shutdown Kit

 Servicing: Nippodenso, Zexel - Visit www.hc-cargo.com for further information

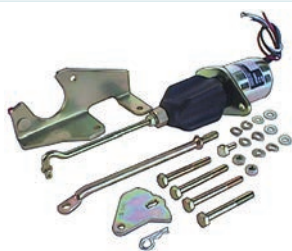
This solenoid can't switch off by itself, it will have to be controlled externally.

 Voltage: 24
 Amp/hold: 0.63
 Amp/pull: 29

 Pull rating: 89N at
 25.40 mm
 Mount. side: Left
 Hold rating: 178N

 Elect. connection: Cable
 Function: Pull
 Switch: External

090106 Solenoid Shutdown Kit

 Servicing: Nippodenso, Zexel - Visit www.hc-cargo.com for further information

This solenoid can't switch off by itself, it will have to be controlled externally.

 Voltage: 24
 Amp/hold: 0.63
 Amp/pull: 29

 Pull rating: 89N at
 25.40 mm
 Mount. side: Right
 Hold rating: 178N

 Elect. connection: Cable
 Function: Pull
 Switch: External

090107 Solenoid Shutdown Kit
This solenoid can't switch off by itself, it will have to be controlled externally.

 Voltage: 12
 Amp/hold: 1.1
 Amp/pull: 55

 Pull rating: 89N at
 25.40 mm
 Mount. side: Left
 Hold rating: 178N

 Elect. connection: Multiplug
 Switch: External

090108 Solenoid Shutdown Kit
This solenoid can't switch off by itself, it will have to be controlled externally.

 Voltage: 24
 Amp/hold: 0.63
 Amp/pull: 29

 Pull rating: 89N at
 25.40 mm
 Mount. side: Left
 Hold rating: 178N

 Elect. connection: Multiplug
 Function: Pull
 Switch: External

INTERNALLY SWITCHED
090097 Solenoid Shutdown Kit
This solenoid can switch off the pull coil, and no external 'control' is necessary.

 Voltage: 12
 Amp/hold: 1.1
 Amp/pull: 46

 Pull rating: 89N at
 25.40 mm
 Mount. side: Left
 Hold rating: 178N

 Elect. connection: Plug
 Function: Pull
 Mount. type: Flange/bracket
 Switch: Internal

090098 Solenoid Shutdown Kit
This solenoid can switch off the pull coil, and no external 'control' is necessary.

 Voltage: 12
 Amp/hold: 1.1
 Amp/pull: 46

 Pull rating: 89N at
 25.40 mm
 Mount. side: Right
 Hold rating: 178N

 Elect. connection: Plug
 Function: Pull
 Switch: Internal

090101 Solenoid Shutdown Kit

This solenoid can switch off the pull coil, and no external 'control' is necessary.



Voltage: 24
Amp/hold: 0.5
Amp/pull: 25

Pull rating: 89N at 25.40 mm
Mount. side: Left
Hold rating: 178N

Elect. connection: Plug
Function: Pull
Switch: Internal

090102 Solenoid Shutdown Kit

This solenoid can switch off the pull coil, and no external 'control' is necessary.



Voltage: 24
Amp/hold: 0.5
Amp/pull: 25

Pull rating: 89N at 25.40 mm
Hold rating: 178N

Elect. connection: Plug
Function: Pull
Switch: Internal

**SOLENOID SHUTDOWN
SHUT OFF SOLENOID**

090218 Plunger



Thread size: M6
Thread size: M6
Thread type: Ordinary

Plunger: External

EXTERNALLY SWITCHED

090109 Shutdown Solenoid

This solenoid can't switch off by itself, it will have to be controlled externally.

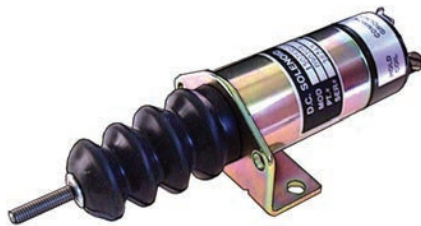

Voltage: 12
Amp/hold: 0.7
Amp/pull: 30

Thread size: 6
Thread type: mm
Pull rating: 40N at 25.40 mm
Return spring: 9N
Hold rating: 89N

Plunger: External
Elect. connection: Plug
Function: Pull
Mount. type: Flange/bracket
Switch: External

090110 Shutdown Solenoid

This solenoid can't switch off by itself, it will have to be controlled externally.



Voltage: 24
Amp/hold: 0.25
Amp/pull: 17

Thread size: 6
Thread type: mm
Pull rating: 40N at 25.40 mm
Return spring: 9N
Hold rating: 89N

Plunger: External
Elect. connection: Plug
Function: Pull
Mount. type: Flange/bracket
Switch: External

090111 Shutdown Solenoid

This solenoid can't switch off by itself, it will have to be controlled externally.



Voltage: 12
Amp/hold: 0.6
Amp/pull: 44

Thread size: 1/4"
Thread type: Inches
Pull rating: 75N at 25.40 mm
Return spring: 35N
Hold rating: 178N

Plunger: External
Elect. connection: Plug
Function: Pull
Mount. type: Flange/bracket
Switch: External

090113 Shutdown Solenoid

This solenoid can't switch off by itself, it will have to be controlled externally.



Voltage: 24
Amp/hold: 0.3
Amp/pull: 23

Thread size: 6
Thread type: mm
Pull rating: 75N at 25.40 mm
Return spring: 35N
Hold rating: 178N

Plunger: External
Elect. connection: Plug
Function: Pull
Mount. type: Flange/bracket
Switch: External

090199 Shutdown Solenoid

This solenoid can't switch off by itself, it will have to be controlled externally.



Voltage: 12
Amp/hold: 1.1
Amp/pull: 46

Thread size: 6
Thread type: mm
Pull rating: 89N at 25.40 mm
Return spring: 17N
Hold rating: 178N

Plunger: External
Elect. connection: Cable
Function: Pull/Push
Mount. type: Flat w/ 2 fixing holes
Switch: External

090200 Shutdown Solenoid

This solenoid can't switch off by itself, it will have to be controlled externally.



Voltage: 24
Amp/hold: 4
Amp/pull: 18

Thread size: 6
Thread type: mm
Pull rating: 67N at 25.40 mm
Return spring: 17N
Hold rating: 178N

Plunger: External
Elect. connection: Cable
Function: Pull/Push
Switch: External

090206 Shutdown Solenoid

Servicing: Yanmar Diesel - Visit www.hc-cargo.com for further information

This solenoid can't switch off by itself, it will have to be controlled externally.



Voltage: 12
Amp/hold: 0.49
Amp/pull: 36.5

Thread size: 0.158
Thread type: inch

Plunger: Internal
Switch: External

090216 Shutdown Solenoid

Servicing: Kubota - Visit www.hc-cargo.com for further information

This solenoid can't switch off by itself, it will have to be controlled externally.



Voltage: 12
Amp/hold: 0.7
Amp/pull: 30

Pull rating: 44N at 25.40 mm
Return spring: 17N
Hold rating: 85N

Plunger: External
Elect. connection: Multiplug
Mount. type: Flange
Switch: External

090225 Shutdown Solenoid

Servicing: Perkins - Visit www.hc-cargo.com for further information

This solenoid can't switch off by itself, it will have to be controlled externally.



Voltage: 12
Amp/hold: 0.49
Amp/pull: 36.5

Thread size: 0.25
Thread type: inch

Plunger: Internal
Switch: External

090226 Shutdown Solenoid

This solenoid can't switch off by itself, it will have to be controlled externally.



Voltage: 24
Voltage 2: 24
Amp/hold: 0.5
Amp/pull: 25

Thread size: 6
Thread type: mm
Pull rating: 111N at 25.40 mm
Return spring: 7N
Hold rating: 182N

Plunger: External
Elect. connection: Multiplug
Function: Pull
Switch: External

090228 Shutdown Solenoid

Servicing: Yanmar Motors - Visit www.hc-cargo.com for further information

This solenoid can't switch off by itself, it will have to be controlled externally.



Voltage: 12
Amp/hold: 0.49
Amp/pull: 36.5

Thread size: 0.158
Thread type: inch

Plunger: Internal
Switch: External

090267 Shutdown Solenoid

Servicing: Volvo wheel loader - Visit www.hc-cargo.com for further information

Syncro start/Woodward.



Voltage: 24
Amp/hold: 0.86
Amp/pull: 39

Pull rating: 129N at 25.4 mm
Hold rating: 182N

Plunger: Cable
Elect. connection: Multiplug
Function: Pull
Switch: External

090281 Shutdown Solenoid

Servicing: Volvo - Visit www.hc-cargo.com for further information

This solenoid can't switch off by itself, it will have to be controlled externally.



Voltage: 24
Amp/hold: 0.5
Amp/pull: 25

Thread size: 6
Thread type: mm
Pull rating: 89N at 25.40 mm
Hold rating: 236N

Plunger: External
Elect. connection: Multiplug
Function: Pull/Push
Mount. type: Bracket
Switch: External

090348 Shutdown Solenoid

This solenoid can't switch off by itself, it will have to be controlled externally.



Voltage: 12
Amp/hold: 1.1
Amp/pull: 46

Thread size: 6
Thread type: mm
Pull rating: 111N at 25.40 mm
Return spring: 4-8N
Hold rating: 182N

Plunger: External
Elect. connection: Cable
Function: Pull
Mount. type: Flat w/ 2 fixing holes
Switch: External

090368 Shutdown Solenoid

Syncro start/Woodward.



Voltage: 12
Voltage 2: 12
Amp/hold: 0.86
Amp/pull: 61

Pull rating: 129N at 25.4 mm
Hold rating: 182N

Plunger: Cable
Elect. connection: Multiplug
Function: Pull
Switch: External

090370 Shutdown Solenoid

 Servicing: Kubota D722, Z482 - Visit www.hc-cargo.com for further information

This solenoid can't switch off by itself, it will have to be controlled externally.

 Voltage: 12
 Amp/hold: 1.1
 Amp/pull: 46

 Pull rating: 111N
 Hold rating: 182N
 Thread size: 1/4 - 28
 UNF-2A

 Plunger: External
 Elect. connection: Cable
 Mount. type: Flat w/ 2 fixing holes
 Switch: External

090371 Shutdown Solenoid

 Servicing: Kubota D722, Z482 - Visit www.hc-cargo.com for further information

This solenoid can't switch off by itself, it will have to be controlled externally.

 Voltage: 24
 Amp/hold: 0.5
 Amp/pull: 25

 Pull rating: 111N
 Hold rating: 182N
 Thread size: 1/4 - 28
 UNF-2A

 Plunger: External
 Elect. connection: Cable
 Switch: External

090373 Shutdown Solenoid
This solenoid can't switch off by itself, it will have to be controlled externally.

 Voltage: 12
 Amp/hold: 0.972
 Amp/pull: 36.5

 Thread size: 5/16"-24
 Thread type: Inch

 Plunger: External
 Switch: External

090431 Shutdown Solenoid
This solenoid can't switch off by itself, it will have to be controlled externally.

 Voltage: 24
 Voltage 2: 24
 Amp/hold: 0.57
 Amp/pull: 30

 Thread size: 5/16"-24
 Thread type: Inches
 Pull rating: 165N
 Return spring: 80-115N
 Hold rating: 391N

 Plunger: External
 Function: Pull
 Mount. type: Flange/bracket
 Switch: External
 Insulated return: Yes

INTERNALLY SWITCHED
090160 Shutdown Solenoid
This solenoid can switch off the pull coil, and no external 'control' is necessary.

 Voltage: 12
 Amp/hold: 0.7
 Amp/pull: 30

 Thread size: 6
 Thread type: mm
 Pull rating: 40N at
 25.40 mm
 Return spring: 17N
 Hold rating: 89N

 Plunger: External
 Elect. connection: Plug
 Mount. type: Flange/bracket
 Switch: Internal

090161 Shutdown Solenoid
This solenoid can switch off the pull coil, and no external 'control' is necessary.

 Voltage: 24
 Amp/hold: 0.25
 Amp/pull: 17

 Thread size: 6
 Thread type: mm
 Pull rating: 40N at
 25.40 mm
 Return spring: 17N
 Hold rating: 89N

 Plunger: Internal
 Elect. connection: Plug
 Function: Pull
 Mount. type: Flange/bracket
 Switch: Internal

090168 Shutdown Solenoid

This solenoid can switch off the pull coil, and no external 'control' is necessary.



Voltage: 12
Amp/hold: 0.6
Amp/pull: 44

Thread size: 6
Thread type: mm
Pull rating: 75N at 25.40 mm
Return spring: 35N
Hold rating: 178N

Plunger: External
Elect. connection: Plug
Mount. type: Flange/bracket
Switch: Internal

090169 Shutdown Solenoid

This solenoid can switch off the pull coil, and no external 'control' is necessary.



Voltage: 24
Amp/hold: 0.3
Amp/pull: 23

Thread size: 6
Thread type: mm
Pull rating: 75N at 25.40 mm
Return spring: 35N
Hold rating: 178N

Plunger: External
Elect. connection: Plug
Function: Pull
Mount. type: Flange/bracket
Switch: Internal
Aux terminal: Yes

090210 Shutdown Solenoid

This solenoid can switch off the pull coil, and no external 'control' is necessary.



Voltage: 12
Amp/hold: 1.1
Amp/pull: 46

Thread size: 1/4"-28 stud.
Thread type: Inches
Pull rating: 89N at 25.40 mm
Return spring: 9N
Hold rating: 178N

Plunger: Internal
Elect. connection: Plug
Function: Pull
Mount. type: Flange/bracket
Switch: Internal
Aux terminal: Yes

090224 Shutdown Solenoid

This solenoid can switch off the pull coil, and no external 'control' is necessary.



Voltage: 12
Amp/hold: 0.25
Amp/pull: 17

Thread size: 6
Thread type: mm
Pull rating: 40N at 25.40 mm
Return spring: 17N
Hold rating: 89N

Plunger: Internal
Switch: Internal

090268 Shutdown Solenoid

Servicing: Kubota 5 series - Visit www.hc-cargo.com for further information

This solenoid can switch off the pull coil, and no external 'control' is necessary.



Voltage: 12
Amp/hold: 0.49
Amp/pull: 36.5

Thread size: 0.155
Thread type: inch

Plunger: Internal
Switch: Internal

090297 Shutdown Solenoid

This solenoid can switch off the pull coil, and no external 'control' is necessary.



Voltage: 24
Amp/hold: 1.1
Amp/pull: 46

Thread size: 6
Thread type: mm
Pull rating: 107N at 25.40 mm
Return spring: 7-11N
Hold rating: 169N

Plunger: External
Switch: Internal
Aux terminal: No

090317 Shutdown Solenoid

This solenoid can switch off the pull coil, and no external 'control' is necessary.



Voltage: 24
Amp/hold: 0.3
Amp/pull: 20

Pull rating: 98N at
32.00 mm
Return spring: 45N
Hold rating: 245N

Plunger: Internal
Switch: Internal
Coil commander: w/

090318 Shutdown Solenoid

This solenoid can switch off the pull coil, and no external 'control' is necessary.



Voltage: 12
Amp/hold: 0.65
Amp/pull: 37

Pull rating: 98N at
32.00 mm
Return spring: 45N
Hold rating: 245N

Plunger: Internal
Switch: Internal

090334 Shutdown Solenoid

Servicing: Sisu Diesel 8366 40253 - Visit www.hc-cargo.com for further information

This solenoid can switch off the pull coil, and no external 'control' is necessary.



Voltage: 12
Amp/hold: 1.1
Amp/pull: 46.5

Pull rating: 89N
Hold rating: 178N

Plunger: Internal
Switch: Internal

090402 Shutdown Solenoid

Servicing: Kubota super 5 series - Visit www.hc-cargo.com for further information

This solenoid can switch off the pull coil, and no external 'control' is necessary.



Voltage: 24
Amp/hold: 0.59
Amp/pull: 19.6

Thread size: 0.154
Thread type: inch

Plunger: Internal
Switch: Internal

090430 Shutdown Solenoid

Servicing: Kubota - Visit www.hc-cargo.com for further information

This solenoid can switch off the pull coil, and no external 'control' is necessary.



Voltage: 12
Amp/hold: 0.49
Amp/pull: 36.5

Thread size: 0.158
Thread type: inch

Plunger: Internal
Switch: Internal

PULL COIL TIMER MODULES
090115 Pull Coil Timer

Voltage: 12

No./wires: 3

090116 Pull Coil Timer

Voltage: 24

No./wires: 3

ADVANCE SOLENOIDS
080940 Actuator

 Servicing: Fiat, Renault - Visit www.hc-cargo.com for further information

Voltage: 12

080941 Actuator

 Servicing: Ford - Visit www.hc-cargo.com for further information

Voltage: 12

080942 Actuator

 Servicing: Renault - Visit www.hc-cargo.com for further information

Voltage: 12

081117 Actuator

Voltage: 12

081120 Actuator

Voltage: 12

SOLENOID STOP
080177 Solenoid Stop







 Voltage: 12
Voltage 2: 12

 Filter: w/o
Insulated return: No

080178 Solenoid Stop

 Voltage: 24
Voltage 2: 24

 Filter: w/o
Insulated return: No

	EL. SPECIFICATIONS	DIMENSIONS	ADDITIONAL SPECIFICATIONS
080207 Solenoid Stop 	Voltage: 12 Voltage 2: 12		Filter: w/o Insulated return: No
080208 Solenoid Stop 	Voltage: 24 Voltage 2: 24		Filter: w/o Insulated return: No
080209 Solenoid Stop 	Voltage: 12 Voltage 2: 12		Filter: w/o Insulated return: No
080210 Solenoid Stop 	Voltage: 24 Voltage 2: 24		Elect. connection: Plug Filter: w/o Insulated return: Yes
080211 Solenoid Stop 	Voltage: 24 Voltage 2: 24		Filter: w/o Insulated return: No
080212 Solenoid Stop 	Voltage: 12 Voltage 2: 12		Elect. connection: Plug Filter: w/o Insulated return: Yes
080595 Solenoid Stop 	Voltage: 12 Voltage 2: 12		Filter: w/o Insulated return: No

	EL. SPECIFICATIONS	DIMENSIONS	ADDITIONAL SPECIFICATIONS
080680 Solenoid Stop 	Voltage: 12 Voltage 2: 12		Filter: w/
080873 Solenoid Stop 	Voltage: 12 Voltage 2: 12		Filter: w/o
080926 Solenoid Stop 	Voltage: 24 Voltage 2: 24		Filter: w/o
080929 Solenoid Stop 	Voltage: 12 Voltage 2: 12		Elect. connection: Cable Filter: w/o Insulated return: Yes
080994 Solenoid Stop <i>w/o thread on the electrical connection.</i>	Voltage: 12 Voltage 2: 12		Filter: w/o Insulated return: No
080995 Solenoid Stop 	Voltage: 12 Voltage 2: 12		Elect. connection: Multiplug Filter: w/o Insulated return: Yes
080996 Solenoid Stop 	Voltage: 24 Voltage 2: 24		Elect. connection: Multiplug Filter: w/o Insulated return: Yes

080998 Solenoid Stop

 Voltage: 12
Voltage 2: 12

 Filter: w/o
Insulated return: No

081000 Solenoid Stop

 Voltage: 12
Voltage 2: 12

 Function: Push
Type: Coil
Filter: w/o
Insulated return: No

081001 Solenoid Stop
Insulated.

 Voltage: 24
Voltage 2: 24

 Elect. connection: Cable
Function: Pull
Filter: w/o
Insulated return: Yes

081002 Solenoid Stop

 Voltage: 24
Voltage 2: 24

 Elect. connection: Cable
Function: Push
Filter: w/o
Insulated return: Yes

081166 Solenoid Stop

 Voltage: 12
Voltage 2: 12

 Filter: w/o
Insulated return: No

PUMPS & PUMP PARTS

ELECTRICAL BILGE PUMPS

070154 Bilge Pump

Model UP500. Completely submersible bilge pump. Compact design w/ ABS material housing, corrosion resistant. Shaft seal made of ceramic and graphite which ensures lubrication and leak resistance. Water inlet strainer slots will screen particles present in the bilge allowing easy running. Pump body can be dismantled by a simple snap-off movement for easy inspection and cleaning.

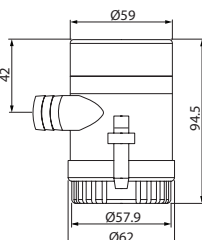
 Voltage: 12
Amp: 5

 Dim.: 94.5x59 mm
Hose connection: 19 mm
Lift height: 4 m
Weight: 0.4 kg
Capacity: 32 l/min
Pressure: 0.45 bar
Pressure: 6.5 psi

 Gasket: Ceramic
Type: Bilge
Pump housing: ABS plastic
Pump shaft: Stainless steel
ISO norm: 8849/8846

070155 Bilge Pump

Model UP1000. Completely submersible bilge pump. compact design w/ ABS material housing, corrosion resistant. Shaft seal made of ceramic and graphite which ensures lubrication and leak resistance. Water inlet strainer slots will screen particles present in the bilge allowing easy running. Pump body can be dismantled by a simple snap-off movement for easy inspection and cleaning.



Voltage: 12
Amp: 10

Dim.: 124.7x78 mm
Hose connection: 28.6 mm
Lift height: 4 m
Weight: 0.8 kg
Capacity: 63 l/min
Pressure: 0.45 bar
Pressure: 6.5 psi

Gasket: Ceramic
Type: Bilge
Pump housing: ABS plastic
Pump shaft: Stainless steel
ISO norm: 8849/8846

070156 Bilge Pump

Model UP1500. Completely submersible bilge pump. Compact design w/ ABS material housing, corrosion resistant. Shaft seal made of ceramic and graphite which ensures lubrication and leak resistance. Water inlet strainer slots will screen particles present in the bilge allowing easy running. Pump body can be dismantled by a simple snap-off movement for easy inspection and cleaning.

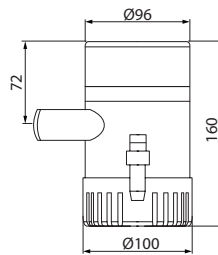

Voltage: 12
Amp: 20

Dim.: 160x96 mm
Hose connection: 26.5 mm
Lift height: 4 m
Weight: 1.3 kg
Capacity: 95 l/min
Pressure: 0.45 bar
Pressure: 6.5 psi

Gasket: Ceramic
Type: Bilge
Pump housing: ABS plastic
Pump shaft: Stainless steel
ISO norm: 8849/8846

070157 Bilge Pump

Model UP2000. Completely submersible bilge pump. compact design w/ ABS material housing, corrosion resistant. Shaft seal made of ceramic and graphite which ensures lubrication and leak resistance. Water inlet strainer slots will screen particles present in the bilge allowing easy running. Pump body can be dismantled by a simple snap-off movement for easy inspection and cleaning.

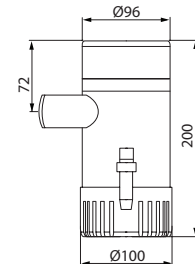

Voltage: 12
Amp: 25

Dim.: 200x96 mm
Hose connection: 31.8 mm
Lift height: 4 m
Weight: 1.8 kg
Capacity: 126 l/min
Pressure: 0.45 bar
Pressure: 6.5 psi

Gasket: Ceramic
Type: Bilge
Pump housing: ABS plastic
Pump shaft: Stainless steel
ISO norm: 8849/8846

ACCESSORIES

070160 Automatic Float Switch

Made of corrosion resistant materials.



Voltage: 12/24
Amp: 10

Dim.: 113x83x62 mm
Height/closed: 22
Height/open: 57

Floating switch: w/

ELECTRICAL WATER PUMPS

070144 Water Pump

Servicing: Renault - Visit www.hc-cargo.com for further information

Model UP1-N. Self priming (1.5 m) electric water pump w/ self-lubricating flexible impeller for prolonged service life and better performance. Pump body made of brass w/ stainless steel shaft and a rubber lip seal. 1/2" BSP inner thread and ID 25 mm bore hose connections. Main application: as a bilge pump.

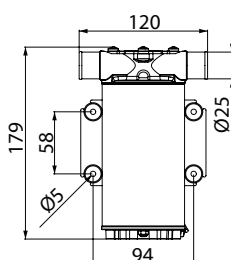

Voltage: 12
Amp: 20

Dim.: 176x120x94 mm
Hose connection: 25 mm
Capacity: 35 l/min
Pressure: 0.8 bar
Pressure: 11.6 psi

Type: Impeller
Pump housing: Brass
Pump shaft: Stainless steel
Impeller: Rubber
Non return valve: Yes
ISO norm: 8849/8846

070145 Water Pump

Model UP1-N. Self priming (1.5 m) electric water pump w/ self-lubricating flexible impeller for prolonged service life and better performance. Pump body made of brass w/ stainless steel shaft and a rubber lip seal. 1/2" BSP inner thread and ID 25 mm bore hose connections. Main application: as a bilge pump.

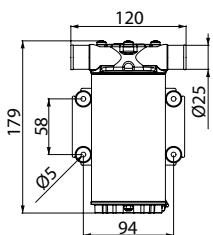

Voltage: 24
Amp: 15

Dim.: 176x120x94 mm
Hose connection: 25 mm
Capacity: 35 l/min
Pressure: 0.8 bar
Pressure: 11.6 psi

Type: Water, Impeller
Pump housing: Brass
Pump shaft: Stainless steel
Impeller: Rubber
Non return valve: Yes
ISO norm: 8849/8846

070153 Water Pump

Servicing: Opel - Visit www.hc-cargo.com for further information

Model UP6/ oil. Self-priming 1.5 m. Electrical gear pump particularly suitable for the transfer of lubricating oils or viscous liquids. Professional model complete w/ two brass connections for 14 mm inner tube and one additional quick-fit for 8 mm external tubing. The pump can be used for extracting lubricating oil out of oil sumps of engines. Pump body made of brass w/ bronze gears, stainless steel shaft and a rubber lip seal.

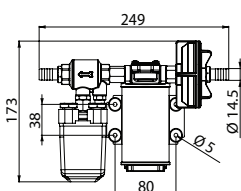

Voltage: 12
Amp: 10

Dim.: 163x249x118 mm
Hose connection: 13 mm
Weight: 2.2 kg
Capacity: 14 l/min
Pressure: 2 bar
Pressure: 29 psi

Type: Gear
Pump housing: Brass
Pump shaft: Stainless steel
Pinion: PTFE
Filter: w/
Non return valve: Yes

070172 Water Pump

Model UP4/A. Self priming electric gear pump equipped w/ pressure switch, non-return valve to be used as automatic pump for water pressure system on boats, mobile homes etc. Bronze gears and rubber lip seal.

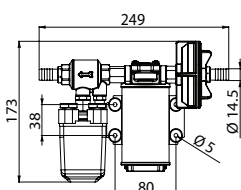

Voltage: 24
Amp: 5

Dim.: 163x249x118 mm
Hose connection: 14 mm
Weight: 2.2 kg
Capacity: 14 l/min
Pressure: 2 bar
Pressure: 29 psi

Type: Water, Gear
Pump housing: Brass
Pump shaft: Stainless steel
Pinion: PTFE
Filter: w/
Non return valve: Yes

CIRCULATION TYPE
070192 Circulation Pump

Servicing: Ford, Seat, VW - Visit www.hc-cargo.com for further information

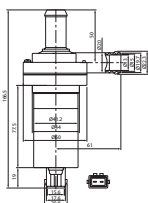

Voltage: 12

Hose connection: 20 mm
Capacity: 14 l/min

Type: Water, Impeller

070203 Circulation Pump

Servicing: Saab, Scania, Ferrari, Maserati, Opel, Vauxhall - Visit www.hc-cargo.com for further information

Junior Timer Connector: HC-CARGO 192146. (see Workshop Cons. & Tools)

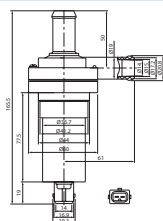

Voltage: 12

Hose connection: 19 mm
Capacity: 18 l/min

Type: Water, Impeller
Filter: w/

070206 Circulation Pump

Servicing: Mercedes-Benz - Visit www.hc-cargo.com for further information



Voltage: 12

Hose connection: 19 mm
Capacity: 18 l/min

Type: Water, Impeller
Filter: w/o

SPARE PARTS
070146 Impeller

Servicing: HC-CARGO 070144, 070145



Impeller: Rubber

ACCESSORIES
070207 In line Filter

Servicing: HC-CARGO 070153

Diameter: 14 mm.

ELECTRICAL FLUID PUMPS
070147 Fluid Pump

Servicing: Main application: transfer of diesel fuel, water antifreeze etc.

Model UP/3. self-priming 1.5 m. Electric pump w/ bronze gears for transfer of various liquids, complete w/ inline filter. Pump body made of brass w/ stainless steel shaft and a rubber lip seal. 3/8" BSP w/ brass connection for I.D. 14 mm inner tubing.

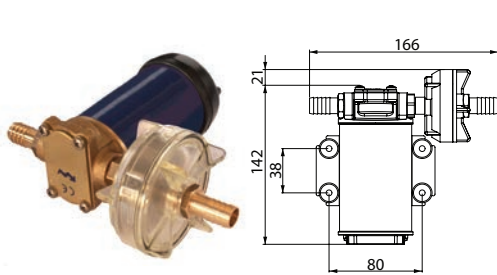
 Voltage: 12
Amp: 10

 Dim.: 163x166x95 mm
Hose connection: 14 mm
Weight: 1.4 kg
Capacity: 14 l/min
Pressure: 2 bar
Pressure: 29 psi

 Type: Gear
Pump housing: Brass
Pump shaft: Stainless steel
Pinion: Brass
Filter: w/

070148 Fluid Pump

Servicing: Main application: transfer of diesel fuel, water antifreeze etc.

Model UP/3. self-priming 1.5 m. Electric pump w/ bronze gears for transfer of various liquids, complete w/ inline filter. Pump body made of brass w/ stainless steel shaft and a rubber lip seal. 3/8" BSP w/ brass connection for I.D. 14 mm inner tubing.

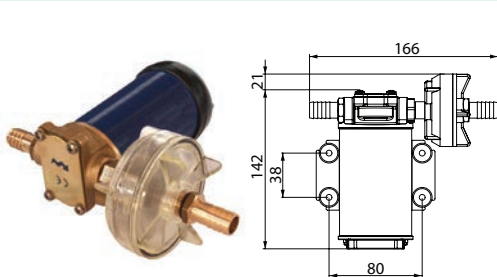
 Voltage: 24
Amp: 5

 Dim.: 163x166x95 mm
Hose connection: 14 mm
Weight: 1.4 kg
Capacity: 14 l/min
Pressure: 2 bar
Pressure: 29 psi

 Type: Gear
Pump housing: Brass
Pump shaft: Stainless steel
Pinion: Brass
Filter: w/

070149 Fluid Pump

Servicing: Main application: transfer of diesel fuel, water antifreeze etc.

Self-priming electric pump w/ helical bronze gears, complete with in-line filter. Nickel plated brass body w/ stainless steel shaft. Ports: 1/2" BSP w/ brass connection for Ø 16 mm inner tubing.

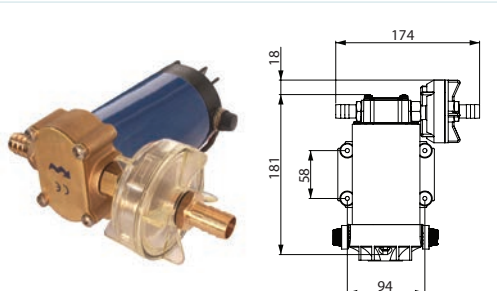
 Voltage: 12
Amp: 15

 Dim.: 199x174x108 mm
Hose connection: 16 mm
Weight: 3.1 kg
Capacity: 26 l/min
Pressure: 2 bar
Pressure: 29 psi

 Type: Fluid, Gear
Pump housing: Brass
Pump shaft: Stainless steel
Pinion: Brass
Filter: w/

070150 Fluid Pump

Servicing: Main application: transfer of diesel fuel, water antifreeze etc.

Self-priming electric pump w/ helical bronze gears, complete with in-line filter. Nickel plated brass body w/ stainless steel shaft. Ports: 1/2" BSP w/ brass connection for Ø 16 mm inner tubing.

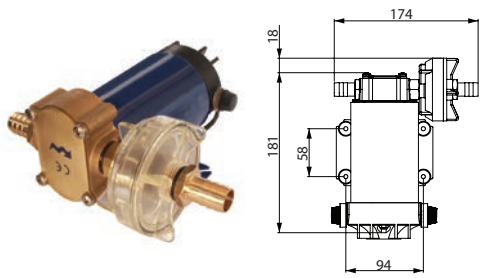

 Voltage: 24
Amp: 7.5

 Dim.: 199x174x108 mm
Hose connection: 16 mm
Weight: 3.1 kg
Capacity: 26 l/min
Pressure: 2 bar
Pressure: 29 psi

 Type: Gear
Pump housing: Brass
Pump shaft: Stainless steel
Pinion: Brass
Filter: w/

070151 Fluid Pump

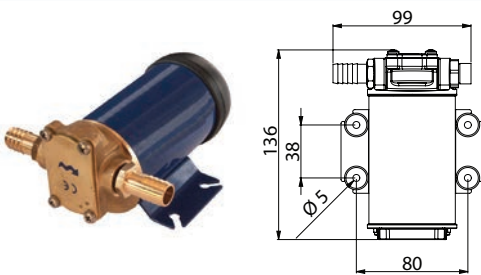
Model UP3/ oil. Self-priming 1 m. Electrical gear pump particularly suitable for the transfer of lubricating oils or viscous liquids. Complete w/ two brass connections for 14 mm inner tube and one additional quick-fit for 8 mm external tubing. The pump can be used for extracting lubricating oil out of oil sumps of engines. Pump body made of brass w/ bronze gears, stainless steel shaft and a rubber lip seal.



 Voltage: 12
Amp: 7.5

 Dim.: 139x108x86 mm
Hose connection: 14 mm
Weight: 1.4 kg
Capacity: 5.5 l/min

 Gasket: Rubber
Type: Fluid, Gear
Pump housing: Brass
Pump shaft: Stainless steel
Pinion: Bronze
Non return valve: Yes

070152 Fluid Pump

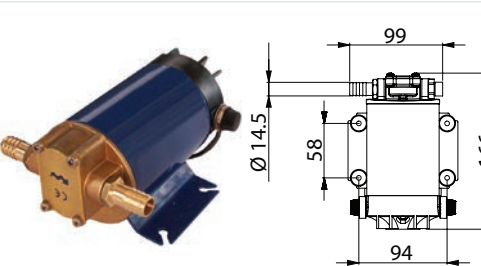
Model UP6/ oil. Self-priming 1.5 m. Electrical gear pump particularly suitable for the transfer of lubricating oils or viscous liquids. Professional model complete w/ two brass connections for 14 mm inner tube and one additional quick-fit for 8 mm external tubing. The pump can be used for extracting lubricating oil out of oil sumps of engines. Pump body made of brass w/ bronze gears, stainless steel shaft and a rubber lip seal.



 Voltage: 12
Amp: 10

 Dim.: 166x117x94 mm
Hose connection: 14 mm
Weight: 2.5 kg
Capacity: 8 l/min
Pressure: 2 bar
Pressure: 29 psi

 Type: Fluid, Gear
Pump housing: Brass
Pump shaft: Stainless steel
Pinion: Bronze

070173 Fluid Pump

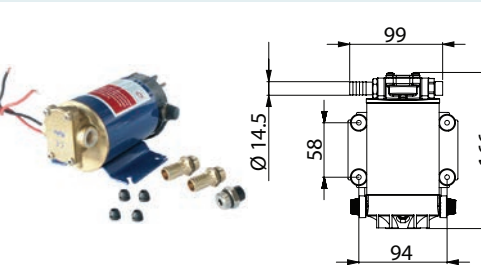
Model UP6 w/ oil. Self-priming 1.5 m. Electrical gear pump particularly suitable for the transfer of lubricating oils or viscous liquids. Professional model complete w/ two brass connections for 14 mm inner tube and one additional quick-fit for 8 mm external tubing. The pump can be used for extracting lubricating oil out of oil sumps of engines.



 Voltage: 24
Amp: 7.5

 Dim.: 166x117x94 mm
Hose connection: 14 mm
Weight: 2.5 kg
Capacity: 8 l/min
Pressure: 2 bar
Pressure: 29 psi

 Type: Fluid, Gear
Pump housing: Brass
Pump shaft: Stainless steel
Impeller: Rubber
Pinion: Bronze

070208 Electrical Fluid Pump HD

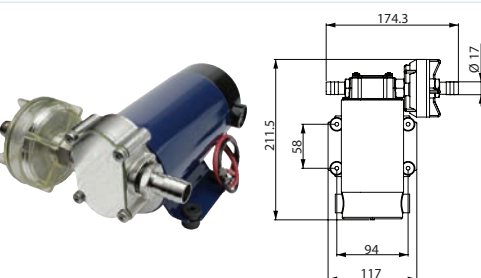
Model UP12. Self-priming 4 m.



 Voltage: 12
Amp: 30

 Dim.: 212x174x109 mm
Hose connection: 16 mm
Weight: 4.3 kg
Capacity: 40 l/min
Pressure: 2.5 bar
Pressure: 36 psi

 Type: Fluid, Gear
Pump housing: Brass
Pump shaft: Stainless steel
Pinion: Bronze
Filter: w/
Non return valve: Yes

070209 Electrical Fluid Pump HD

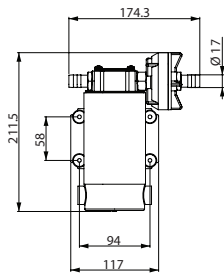
Model UP12. Self-priming 4 m.



Voltage: 24
Amp: 15

Dim.: 212x174x109 mm
Hose connection:
16 mm
Weight: 4.3 kg
Capacity: 40 l/min
Pressure: 2.5 bar
Pressure: 36 psi

Type: Fluid, Gear
Pump housing: Brass
Pump shaft: Stainless steel
Pinion: Bronze
Filter: w/
Non return valve: Yes

SPARE PARTS

070182 Brush Set

Servicing: HC-CARGO 070144, -145, -149, -150, -152



Length: 18.1 mm
Height: 8.6 mm
Thickness: 5.6 mm

ELECTRICAL FUEL PUMPS

INTERRUPTER PUMPS

070003 Fuel Pump

Built in Pressure Relief: assures an immediate return to zero pressure when the ignition is turned off. Prevents flooding and assures satisfactory restarting on the hottest days. Vertical mounting near tank is preferred. to 1.1 mtr. Fuel lift. Inlet/outlet 1/8"-27 thread. Fitting instruction. Fuel delivery capacity: 113.5 litre/h. Tested at: +60°C Incl. 2 pcs. 6 mm hose nipples. 8 mm: HC-CARGO 080955. 8 mm angle: HC-CARGO 070181. 10 mm: HC-CARGO 081154.



Voltage: 12

Capacity: 113.5 l/h
Pressure: 4-5 psi

Type: Universal

070004 Fuel Pump

Built in Pressure Relief: assures an immediate return to zero pressure when the ignition is turned off. Prevents flooding and assures satisfactory restarting on the hottest days. Vertical mounting near tank is preferred. to 1.1 mtr. Fuel lift. Inlet/outlet 1/8"-27 thread. Fitting instruction. Fuel delivery capacity: 113.5 litre/h. Tested at: +60°C. Incl. 2 pcs. 6 mm hose nipples. 8 mm: HC-CARGO 080955. 8 mm angle: HC-CARGO 070181.



Voltage: 24

Capacity: 113.5 l/h
Pressure: 4-5 psi

Type: Universal

070058 Fuel Pump

Servicing: Thermo King, Carrier - Visit www.hc-cargo.com for further information

Built in Pressure Relief: assures an immediate return to zero pressure when the ignition is turned off. Prevents flooding and assures satisfactory restarting on the hottest days. Vertical mounting near tank is preferred. to 1.1 mtr. Fuel lift. Inlet/outlet 1/8"-27 thread. Fitting instruction. Fuel delivery capacity: 113.5 litre/h. Tested at: +60°C. Incl. 2 pcs. 6 mm hose nipples. 8 mm: HC-CARGO 080955. 8 mm angle: HC-CARGO 070181.



Voltage: 12

Capacity: 87 l/h
Pressure: 7-9.5 psi

Type: Universal

070076 Fuel Pump
w/ integral filter.

Voltage: 12

 Capacity: 113 l/h
 Pressure: 9-11.5 psi

 Fuel: Gasoline, diesel, ethanol, methanol
 Type: Universal

070134 Fuel Pump

 Servicing: New-Holland, Same - Visit www.hc-cargo.com for further information

Built in Pressure Relief: assures an immediate return to zero pressure when the ignition is turned off. Prevents flooding and assures satisfactory restarting on the hottest days. Vertical mounting near tank is preferred. to 1.1 mtr. Fuel lift. Inlet/outlet 1/8"-27 thread. Fitting instruction. Fuel delivery capacity: 113.5 litre/h. Tested at: +60°C

Voltage: 12

 Thread: In/out 1/4-18"
 Capacity: 136 l/h
 Pressure: 4-5 psi

Type: Universal

ACCESSORIES
070177 Filter

Servicing: HC-CARGO 070003, 070004, 070058, 070134

PRESSURE PUMPS
070032 Fuel Pump
Hose nipple 8 mm. Suction 1 mtr. Connectors can be rotated. Fitting instruction included.

Voltage: 12

 Capacity: 120 l/h
 Pressure: 0.2 bar

 Fuel: Gasoline, diesel, ethanol, methanol
 Type: Universal

070078 Fuel Pump
Hose nipple 8 mm. Suction 1.5 mtr. Connectors can be rotated. Fitting instruction included.

Voltage: 12

 Capacity: 125 l/h
 Pressure: 0.35 bar







Type: Universal

070107 Fuel Pump
Hose nipple 8 mm. Suction 1.5 mtr. Connectors can be rotated. Fitting instruction included.

Voltage: 24

 Capacity: 130 l/h
 Pressure: 0.35 bar

 Fuel: Gasoline, diesel, ethanol, methanol
 Type: Universal

EL. SPECIFICATIONS	DIMENSIONS	ADDITIONAL SPECIFICATIONS	
070143 Fuel Pump Servicing: Thermo King/carrier, tested according to SAE J1537 - Visit www.hc-cargo.com for further information			
<i>Suction 1.2 mtr. Fitting instruction included.</i>			
	Voltage: 12	Thread: In/out 1/8" NPSF Capacity: 155 l/h Pressure: 0.1 bar	Fuel: Gasoline, diesel, ethanol, methanol Type: Universal
070161 Fuel Pump			
<i>Hose nipple 8 mm.</i>			
	Voltage: 12	Capacity: 80-150 l/h Pressure: 0.1-0.4 kg Pressure: 1.4-5.7 psi	Type: Universal
ACCESSORIES			
070183 Filter Kit Servicing: Thermo King/Carrier pump 6103 W - Visit www.hc-cargo.com for further information			
<i>For HC-CARGO 070143.</i>			
			Filter type: Insert
HIGH PERFORMANCE FUEL PUMPS			
070187 Fuel Pump			
<i>(Solid state pumps). Universal. Built in Pressure Relief: assures an immediate return to zero pressure when the ignition is turned off. Prevents flooding and assures satisfactory restarting on the hottest days. For cars w/fuel-pressure. Not injection. To be mounted near the tank. The solid state pump is self priming to 30 cm. fuel lift. W/ electronic contacts. Fitting instruction included. Supplied w/ 2 pcs. 6 mm hose connection.</i>			
	Voltage: 12	Thread: In/Out 1/8"-27 NPTF Capacity: 95 l/h Pressure: 0.1-0.3 kg Pressure: 1.5-4 psi	Fuel: Gasoline, diesel, ethanol, methanol Type: Universal
070188 Fuel Pump			
<i>(Solid state pumps). Universal. Built in Pressure Relief: assures an immediate return to zero pressure when the ignition is turned off. Prevents flooding and assures satisfactory restarting on the hottest days. For cars w/fuel-pressure. Not injection. To be mounted near the tank. The solid state pump is self priming to 30 cm. fuel lift. W/ electronic contacts. Fitting instruction included. Replaceable hose nipple. Supplied w/ 2 pcs. 6 mm hose connection.</i>			
	Voltage: 12	Thread: In/Out 1/8"-27 NPTF Capacity: 132 l/h Pressure: 0.3-0.5 kg Pressure: 4-7 psi	Fuel: Gasoline, diesel, ethanol, methanol Type: Universal
070191 Fuel Pump			
<i>(Solid state pumps). Universal. Built in Pressure Relief: assures an immediate return to zero pressure when the ignition is turned off. Prevents flooding and assures satisfactory restarting on the hottest days. For cars w/fuel-pressure. Not injection. To be mounted near the tank. The solid state pump is self priming to 30 cm. fuel lift. W/ electronic contacts. Fitting instruction included. Standard 6 mm hose nipples.</i>			
	Voltage: 12	Thread: In/out M8 Capacity: 130 l/h Pressure: 0.5-0.7 kg Pressure: 7-10 psi	Fuel: Gasoline, diesel, ethanol, methanol Type: Universal

SOLID STATE PUMPS

070056 Fuel Pump

Servicing: Caterpillar, IH/Case - Visit www.hc-cargo.com for further information

Built in Pressure Relief: assures an immediate return to zero pressure when the ignition is turned off. Prevents flooding and assures satisfactory restarting on the hottest days. Vertical mounting near tank is preferred. to 1.1 mtr. Fuel lift. Inlet/outlet 1/8"-27 thread. Fitting instruction. Fuel delivery capacity: 113.5 litre/h. Tested at: +60°C.



Voltage: 24

Capacity: 121 l/h
Pressure: 0.3-0.45 kg
Pressure: 4.5-6 psi

Type: Universal

070057 Fuel Pump

Servicing: Thermo King etc - Visit www.hc-cargo.com for further information

Built in Pressure Relief: assures an immediate return to zero pressure when the ignition is turned off. Prevents flooding and assures satisfactory restarting on the hottest days. Vertical mounting near tank is preferred. to 1.1 mtr. Fuel lift. Inlet/outlet 1/8"-27 thread. Fitting instruction. Fuel delivery capacity: 113.5 litre/h. Tested at: +60°C.



Voltage: 12

Capacity: 121 l/h
Pressure: 0.7 kg
Pressure: 10 psi

Fuel: Gasoline, diesel, ethanol, methanol
Type: Universal

SUCTION PUMPS

070019 Fuel Pump

Servicing: Bobcat - Visit www.hc-cargo.com for further information

Suction 0.2 bar = 2.7 mtr. Fitting instruction included.



Voltage: 12

Thread: In/out R-1/4"
Capacity: 120 l/h
Pressure: 0.2 bar

Fuel: Gasoline
Type: Universal

070021 Fuel Pump

Servicing: VW - Visit www.hc-cargo.com for further information

Hose nipple 8 mm. Suction 1 mtr. Connectors can be rotated. Fitting instruction included.



Voltage: 12

Capacity: 120 l/h
Pressure: 0.15 bar

Fuel: Gasoline/diesel
Type: Universal

070184 Fuel Pump

Servicing: VW marine - Visit www.hc-cargo.com for further information

Hose nipple 8 mm. Waterproof. Suction 1 mtr. Connectors can be rotated.



Voltage: 12

Capacity: 120 l/h
Pressure: 0.15 bar

Fuel: Gasoline, diesel, ethanol, methanol
Type: Universal

UNIVERSAL

HOSE NIPPLES

070067 Hose Nipple

Servicing: A005T16384, A5T16384



Hose ID: 10 mm
Thread: R1/4

EL. SPECIFICATIONS	DIMENSIONS	ADDITIONAL SPECIFICATIONS
<p>070070 Hose Nipple</p> 	<p>Hose ID: 10 mm Thread: M16-1.5</p>	
<p>070077 Hose Nipple</p> 	<p>Hose ID: 6 mm Thread: 1/8-27 NPTF</p>	
<p>070181 Hose Nipple 90°.</p> 	<p>Hose ID: 8 mm Thread: R1/8</p>	
<p>080854 Hose Nipple</p> 	<p>Hose ID: 8 mm Thread: M14-1.5</p>	
<p>080855 Hose Nipple</p> 	<p>Hose ID: 10 mm Thread: R1/2</p>	
<p>080857 Hose Nipple</p> 	<p>Hose ID: 8 mm Thread: 1/2-20 UNF</p>	
<p>080858 Hose Nipple</p> 	<p>Hose ID: 8 mm Thread: M16-1.5</p>	
<p>080875 Hose Nipple</p> 	<p>Hose ID: 11 mm Thread: M16-1.5</p>	

080954 Hose Nipple

 Hose ID: 6 mm
 Thread: M14-1.5

080955 Hose Nipple

 Hose ID: 8 mm
 Thread: 1/8-27 NPTF

080958 Hose Nipple

 Hose ID: 10 mm
 Thread: M18-1.5

080959 Hose Nipple

 Hose ID: 10 mm
 Thread: M14-1.5

080960 Hose Nipple

 Hose ID: 10 mm
 Thread: 1/2-20 UNF

081039 Nipple

Servicing: Bosch

081040 Nipple

Servicing: Bosch



DIESEL PUMP KITS

070162 Diesel Transfer/Filter Kit

Includes: 2.5 m suction hose. 2.5 m pressure hose w/ gun. Wired connection w/ alligator clips. Switch on the pump. Bypass valve on the pump ensures that it is not overloaded by closed gun. Not to gasoline.



Voltage: 12
Amp: 15

Dim.: 210x161x120 mm
Hose connection: 25 mm
Capacity: 45 l/min
Pressure: 1.2 bar
Pressure: 17.4 psi

Type: Fluid
Gear
Impeller: Steel
Filter: w/

070175 Diesel Transfer/Filter Kit

2.5 m suction hose w/ filter. 2.5 m pressure hose w/ gun. 2 m cable w/ alligator clips. Switch on the pump. Bypass valve on the pump ensure against overloading. Not for gasoline.



Voltage: 24
Amp: 7.5

Dim.: 210x161x120 mm
Hose connection: 25 mm
Capacity: 45.1 l/min
Pressure: 1.2 bar
Pressure: 17.4 psi

Type: Fluid
Filter: w/

FUEL INJECTION PUMPS

070053 Fuel Injection Pump

Servicing: Alfa Romeo, Austin, BMW, Citroen, Fiat, Jaguar, Lancia, Land Rover, Mercedes-Benz, Opel, Peugeot, Porsche, Renault - Visit www.hc-cargo.com for further information



Voltage: 12

Pressure: 2-3.5 bar

070054 Fuel Injection Pump

Servicing: Alfa Romeo, Citroen, Fiat, Jaguar, Mercedes-Benz, Peugeot, Porsche, Renault, Saab, Volvo - Visit www.hc-cargo.com for further information



Voltage: 12

Pressure: 4 bar

070055 Fuel Injection Pump

Servicing: Ford, Mercedes-Benz - Visit www.hc-cargo.com for further information



Voltage: 12

Pressure: 3 bar

FEED PUMPS

090015 Feed Pump



Type: Plunger
Valves: 2

090016 Feed Pump

 Type: Plunger
 No./mounting holes: 2
 Valves: 2

090020 Feed Pump

 Type: Plunger
 Valves: 2

090151 Feed Pump

 Servicing: Volvo Penta - Visit www.hc-cargo.com for further information

Type: Diaphragm

090156 Feed Pump

 Servicing: Cummins, DAF, I.H - Visit www.hc-cargo.com for further information

Type: Diaphragm

090187 Feed Pump

 Servicing: Fiat, Iveco, New Holland - Visit www.hc-cargo.com for further information

Type: Diaphragm

090197 Feed Pump

 Servicing: Ford Transit 2.5 L - Visit www.hc-cargo.com for further information

Type: Diaphragm

090198 Feed Pump

Type: Plunger

EL. SPECIFICATIONS	DIMENSIONS	ADDITIONAL SPECIFICATIONS
<p>090202 Feed Pump</p> 		<p>Type: Plunger</p>
<p>090235 Feed Pump Servicing: Vetus, Volvo Penta - Visit www.hc-cargo.com for further information</p>		
		<p>Type: Diaphragm</p>
<p>090250 Feed Pump Servicing: Cummins - Visit www.hc-cargo.com for further information</p>		
		<p>Type: Diaphragm</p>
<p>090251 Feed Pump Servicing: Cummins - Visit www.hc-cargo.com for further information</p>		
		<p>Type: Plunger</p>
<p>090253 Feed Pump Servicing: Kubota Industry - Visit www.hc-cargo.com for further information</p>		
		<p>Type: Diaphragm</p>
<p>090254 Feed Pump</p>		
		<p>Type: Diaphragm</p>
<p>090314 Feed Pump</p>		
		<p>Type: Diaphragm</p>

090315 Feed Pump

Type: Plunger

090337 Feed Pump

Type: Diaphragm

090391 Feed Pump

 Servicing: Cummins - Visit www.hc-cargo.com for further information

PARTS
080070 Hand Pump

080071 Hand Pump

 Thread: M14-1.5
 Inlet size: 14

Type: Universal

080099 Gasket

 Servicing: Bosch VE - Visit www.hc-cargo.com for further information

 Type: Diesel
 Material: Viton

080168 Repair Kit

Bushing length: 40.5 mm.



080170 Repair Kit

Servicing: 0460494251

Bushing lenght: 30.5 mm.



080292 Glass Bowl

Servicing: Bosch

For filter glass.



080295 Hand Pump

Thread: M16-1.5



080695 Hand Pump

Thread: M22-1



080703 Hand Pump

For hose I.D. 8 mm.

Type: Universal



080730 Repair Kit

As HC-CARGO 080170 but w/ 2 O-rings and preformed Gasket.

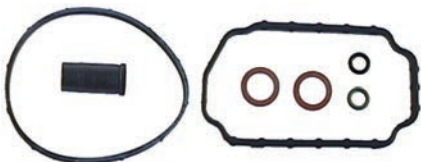

080742 Hand Pump

Thread: M16-1.5



080783 Repair Kit

 Servicing: CAV - Visit www.hc-cargo.com for further information

080793 Hand Pump

Thread: M14-1.5

Type: Universal

080811 Repair Kit

Servicing: Bosch

080840 Hand Pump

Thread: M16-1.5

Material: Steel

080852 Repair Kit

Servicing: Bosch

081003 Union

Servicing: HC-CARGO 080695



Thread: M16-1.5-M22-1

081058 Hot Starting Device

Servicing: VE-EDC pumps for Audi, BMW, Seat, Skoda, VW



EL. SPECIFICATIONS	DIMENSIONS	ADDITIONAL SPECIFICATIONS
<p>090076 Prefilter</p> 		<p>Thread: M14-1.5 Fuel: Diesel Filter type: Prefilter</p>
<p>090144 Prefilter</p> 	<p>OD: M14x1.5 mm</p>	
<p>090159 Hand Pump</p> 	<p>Thread: 1/2"-20 UNF Inlet size: 14</p>	<p>Type: Universal</p>
<p>090421 Gasket Kit Servicing: Stanadyne - Visit www.hc-cargo.com for further information</p>		
		
<p>DIESEL PUMP PARTS</p>		
<p>080038 Air Screw Servicing: DPA</p>		
		
<p>080114 Hollow Screw</p>		
	<p>Hole size: 5.5 mm</p>	<p>Calibrated: Yes</p>
<p>080352 Steel Gasket</p>		
<p><i>For injection outlet.</i></p> 	<p>ID: 9.7 mm OD: 12.7 mm Thickness: 1.9 mm</p>	

080752 Diaphragm

Servicing: DPC



080757 Diaphragm

Servicing: DPS



080969 Diaphragm

Servicing: DPC



090047 Repair Kit



090277 Start Advance

Servicing: Talbot - Visit www.hc-cargo.com for further information



090278 Start Advance

Servicing: Citroen, Peugeot - Visit www.hc-cargo.com for further information



INJECTORS

100597 Injector

Servicing: Yanmar air cooled single cylinder, Engine type: YDLL YPFE-M, fitted w/ nozzle DLLA 150P 224, Opening pressure: 196 bar - Visit www.hc-cargo.com for further information



100598 Injector

Servicing: Yanmar air cooled single cylinder, Engine type: YDLL YPFE-M, fitted w/ nozzle DLLA 150P 224, Opening pressure: 196 bar - Visit www.hc-cargo.com for further information



INJECTOR NUTS

081097 Injector Nut

For Common Rail.



REGULATOR KITS

090244 Governor Kit

Servicing: CAV Minimec - Visit www.hc-cargo.com for further information



FILTERS & FILTER PARTS

FUEL FILTERS

090193 Filter House

90 l/hour.



Water separator: Yes

090194 Filter House

Flow 150 l/h.



Water separator: Yes

090203 Filter House

Servicing: Ford Fiesta, Mondeo, Transit - Visit www.hc-cargo.com for further information

150 l/hour.



Hand pump: Yes
Water separator: Yes

090213 Filter House

Flow 150 l/h.



Water separator: Yes

090345 Filter Kit

090346 Filter Kit

090404 Filter House

Water separator: Yes

AS301 Fuel Filter

 Servicing: Alfa Romeo, Audi, Citroen, Fiat, Ford, Land Rover, Peugeot, Renault, Seat, Volvo - Visit www.hc-cargo.com for further information

Fuel: Diesel

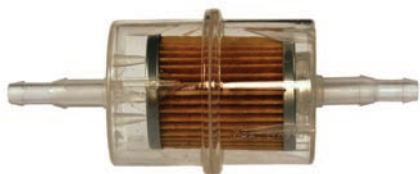





RT1000 Fuel Filter

 ID/hose: 6 mm
 ID/hose 2: 8 mm

 Fuel: Gasoline
 Universal: Yes
 Transparent: Yes

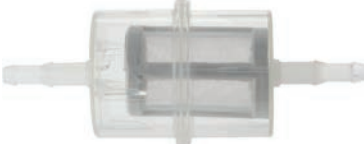
RT1003 Fuel Filter

 ID/hose: 6 mm
 ID/hose 2: 8 mm

 Fuel: Gasoline
 Universal: Yes
 Transparent: Yes

EL. SPECIFICATIONS	DIMENSIONS	ADDITIONAL SPECIFICATIONS
RT1005 Fuel Filter		
	ID/hose: 8 mm ID/hose 2: 8 mm	Fuel: Gasoline Universal: Yes Transparent: Yes
RT2002 Fuel Filter		
<i>Only for diesel fuel.</i>		
	ID/hose: 6 mm ID/hose 2: 8 mm	Fuel: Diesel Universal: Yes Transparent: Yes
RT2006 Fuel Filter		
<i>281 micron.</i>		
	ID/hose: 6 mm ID/hose 2: 8 mm	Fuel: Diesel Universal: Yes Transparent: Yes
RT2016 Fuel Filter		
<i>Servicing: Seat, Peugeot, VW, Volvo, Vauxhall, Peugeot, Seat, Vauxhall, Volvo, VW - Visit www.hc-cargo.com for further information</i>		
	ID/hose: 6 mm ID/hose 2: 8 mm	Fuel: Diesel Universal: Yes Transparent: Yes
FUEL HEATERS		
080944 Heat Exchanger		
		Type: Water Sandwich type: Yes
081176 Fuel Heater		
	Voltage: 12 Watt: 150	Demister tube connection: 8/10 mm Type: Electric Sandwich type: No
WATER SEPARATOR		
090145 Water Separator		
		Universal: Yes

090146 Water Separator

Universal: Yes

SPARE PARTS
080465 Gasket

 Servicing: CAV - Visit www.hc-cargo.com for further information

 ID: 15 mm
 OD: 28 mm
 Thickness: 3 mm

080701 Gasket

 Servicing: CAV - Visit www.hc-cargo.com for further information

For filter glass.

 ID: 80 mm
 OD: 88 mm
 Thickness: 3 mm

080702 Gasket

 Servicing: CAV - Visit www.hc-cargo.com for further information

For filter glass.

 ID: 77 mm
 OD: 84 mm
 Thickness: 3 mm

080805 Gasket

 Servicing: CAV - Visit www.hc-cargo.com for further information

For filter glass.

 ID: 41.5 mm
 OD: 54 mm
 Thickness: 3 mm

081007 Gasket Kit

 Servicing: CAV - Visit www.hc-cargo.com for further information

090071 Single Cover

Universal: Yes

090072 Single Cover

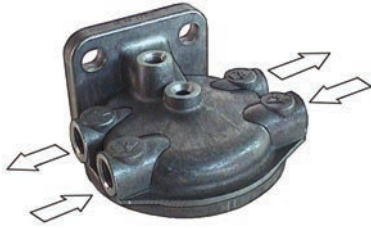

Universal: Yes

090073 Glass Bowl

Servicing: HC-CARGO 090193



090127 Filter Cup

Servicing: HC-CARGO 090193



090166 Filter Cover

Filter thread 16x1.5 mm.

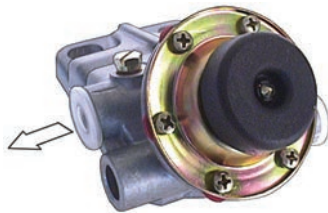

Hand pump: Yes

090167 Filter Cover

Servicing: Bosch, VW, GM - Visit www.hc-cargo.com for further information

Filter thread 16x1.5 mm.



Hand pump: Yes
Universal: Yes

090172 Glass

For water separator.



090316 Filter Top



Hand pump: Yes
Universal: Yes

EL. SPECIFICATIONS

DIMENSIONS

ADDITIONAL SPECIFICATIONS

090319 Filter Top

Servicing: HC-CARGO 090345



090320 Filter Top

Servicing: HC-CARGO 090346



090347 Filter Top

Servicing: Japanese appl - Visit www.hc-cargo.com for further information

8 mm hose I.D.



Hand pump: Yes
Universal: Yes

090381 Filter Top

Filter thread 16x1.5 mm.



Universal: Yes

DIESEL PARTS

BEARINGS

090061 Repair Kit



DIESEL PUMP PARTS

080614 Rotor Vane Set

Servicing: CAV DPA/DPC - Visit www.hc-cargo.com for further information

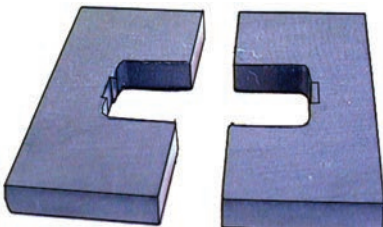

080773 Rotor Vane Set

Servicing: DPA

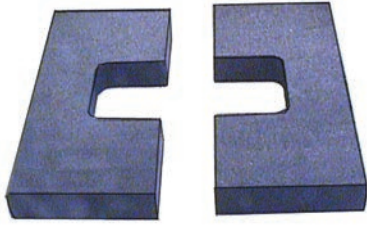

080815 Liner

Servicing: CAV DPA - Visit www.hc-cargo.com for further information



080816 Liner

Servicing: CAV DPA - Visit www.hc-cargo.com for further information



080824 Rotor Vane Set

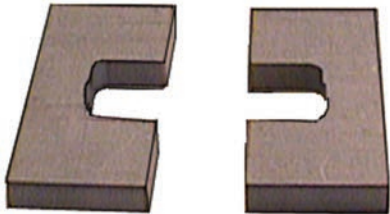

081004 Injector Nut

Servicing: Volvo Penta - Visit www.hc-cargo.com for further information



090027 Repair Kit

Servicing: Bosch PE6P - Visit www.hc-cargo.com for further information

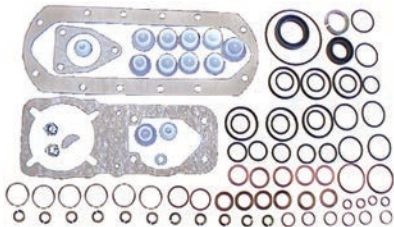

090042 Damper

Servicing: Bosch

w/ air drain.



090055 Gasket Kit

Servicing: CAV DPA pumps - Visit www.hc-cargo.com for further information

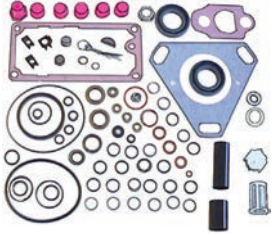

090057 Cover

Servicing: CAV DPS - Visit www.hc-cargo.com for further information



090062 Damper

Servicing: Bosch



090090 Repair Kit

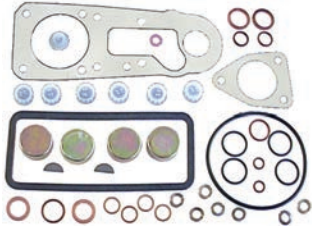

090136 Gasket Kit

Servicing: CAV DPC "Turbo" - Visit www.hc-cargo.com for further information

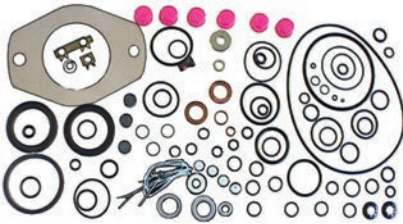

090150 End Plate



090222 Gasket Kit

Servicing: Simms Minimec 4 cyl, CAV - Visit www.hc-cargo.com for further information

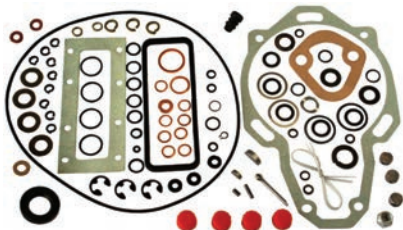

090223 Gasket Kit

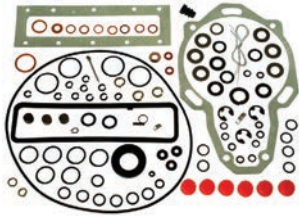

090233 Cover



090242 Gasket Kit

Servicing: Stanadyne DB2 - Visit www.hc-cargo.com for further information



090246 Gasket Kit

Servicing: VW - Visit www.hc-cargo.com for further information

Repair kit for VW injector pumps. Incl. Parts for 5 injectors.



090294 Gasket Kit

Servicing: CAV Epic, Lucas Epic - Visit www.hc-cargo.com for further information



090344 Gasket Kit

Servicing: Stanadyne DB4 - Visit www.hc-cargo.com for further information



FEED PUMPS

090001 Feed Pump



Type: Diaphragm

090183 Feed Pump



Type: Diaphragm

090192 Feed Pump



Type: Diaphragm

090333 Feed Pump



Type: Diaphragm

090362 Feed Pump



PARTS

080059 Valve Repair Kit

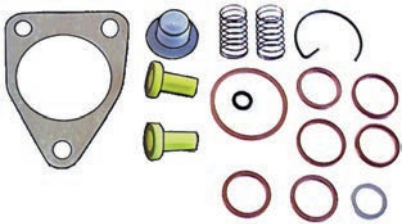

080060 Valve Repair Kit



080064 Valve Repair Kit

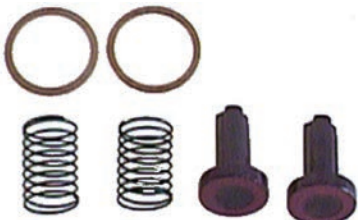

EL. SPECIFICATIONS	DIMENSIONS	ADDITIONAL SPECIFICATIONS
<p>080097 Oil Seal</p> 	<p>Servicing: VE pumps</p> <p>ID: 20 mm OD: 31.1 mm Height: 6.9 mm</p>	
<p>080205 Gasket</p> 	<p>Servicing: CAV - Visit www.hc-cargo.com for further information</p>	
<p>080294 Repair Kit</p> 		
<p>080738 Gasket</p> 		
<p>080766 Valve Repair Kit</p> 		
<p>080813 Oil Seal</p> 		
<p>080933 Gasket</p> 	<p>Servicing: CAV DPA - Visit www.hc-cargo.com for further information</p>	<p>Material: Cardboard</p>

080953 Oil Seal



080963 Rubber Gasket



080964 Rubber Gasket

Servicing: CAV various - Visit www.hc-cargo.com for further information

Material: Rubber



080972 Gasket



FILTER PARTS

080721 Plug



080809 Plug

Servicing: CAV - Visit www.hc-cargo.com for further information



090074 Glass Bowl

Servicing: HC-CARGO 090213, 090404, CAV



FUEL FILTERS

RT2005 Fuel Filter

Servicing: Daewoo, Mercedes-Benz, Ssangyong - Visit www.hc-cargo.com for further information

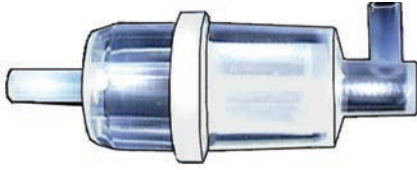

ID/hose: 8 mm

Fuel: Diesel
Transparent: Yes

GOVERNOR PARTS

090147 Diesel Injection Pump

Servicing: Bosch RSV Turbo - Visit www.hc-cargo.com for further information



INJECTION PIPE HOLDERS

080046 Injection Pipe Holder

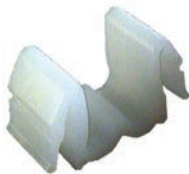

Material: Plastic
No./pipes: 2

080047 Injection Pipe Holder



Material: Plastic
No./pipes: 3

INJECTION PIPES

090086 Injection Pipe



ID: 1.5 mm
OD: 6 mm
Length: 3000 mm

Universal: Yes

090087 Injection Pipe



ID: 2 mm
OD: 6 mm
Length: 3000 mm

Universal: Yes

NOZZLE HOLDER PARTS

080055 Inj. Pipe Nut Set



OD: 6 mm
Thread size: M14-1.5
Thread size: M14-1.5

	EL. SPECIFICATIONS	DIMENSIONS	ADDITIONAL SPECIFICATIONS
080338 Injector Spacer 	Servicing: Bosch		
080340 Injector Spacer 	Servicing: Bosch, kbal, kdal - Visit www.hc-cargo.com for further information		
080345 Injector Spacer 	Servicing: Bosch, KBE - Visit www.hc-cargo.com for further information		
080389 Injector Washer 		ID: 12.1 mm OD: 23 mm Thickness: 1 mm	Overflow washers: Copper
080457 Injector Washer 	Servicing: Mitsubishi, Nissan, Toyota, mm - Visit www.hc-cargo.com for further information	ID: 12 mm OD: 18.5 mm Thickness: 1 mm	Overflow washers: Aluminium
080458 Injector Washer 		ID: 12.5 mm OD: 22.5 mm Thickness: 1 mm	Overflow washers: Aluminium
080459 Injector Washer 		ID: 12 mm OD: 19.1 mm Thickness: 1 mm	Overflow washers: Copper

EL. SPECIFICATIONS	DIMENSIONS	ADDITIONAL SPECIFICATIONS
080467 Plug Servicing: Bosch - Mercedes - Visit www.hc-cargo.com for further information		
		
080582 Eye Union Overflow Spanner size 24 mm.		
		Overflow washers: Brass No./nipples: 1
080583 Eye Union Overflow Spanner size 27 mm.		
		Overflow washers: Brass No./nipples: 2
080778 Injector Washer		
		
080877 Adjustment Shims		
		ID: 3 mm OD: 8.5 mm Thickness: 0.85 mm
080878 Adjustment Shims Servicing: Bosch		
		ID: 3 mm OD: 8.5 mm Thickness: 0.9 mm
080879 Adjustment Shims Servicing: Bosch		
		ID: 3 mm OD: 8.5 mm Thickness: 0.95 mm

081041 Overflow Kit

Hose 100 cm.



No./nipples: 4

081129 Injector Seal Kit

 Servicing: Opel - Visit www.hc-cargo.com for further information

NOZZLES
100342 Nozzle

 Servicing: Audi, Fiat, Ford, Mazda, Nissan, Renault, Volvo, VW - Visit www.hc-cargo.com for further information

 Code type: DN0SD193
 Nozzle type: Diesel

100344 Nozzle

 Servicing: BMW, Mercedes-Benz, Peugeot, Toyota - Visit www.hc-cargo.com for further information

 Code type: DN0SD220
 Nozzle type: Diesel

100348 Nozzle

 Servicing: Audi, Volvo, VW - Visit www.hc-cargo.com for further information

 Code type: DN0SD293
 Nozzle type: Diesel

100352 Nozzle

 Servicing: Mercedes-Benz - Visit www.hc-cargo.com for further information

 Code type: DN0SD265
 Nozzle type: Diesel

100353 Nozzle

 Servicing: Alfa Romeo - Visit www.hc-cargo.com for further information

 Code type: DN12SD12
 Nozzle type: Diesel

EL. SPECIFICATIONS	DIMENSIONS	ADDITIONAL SPECIFICATIONS
<p>100358 Nozzle</p> 		<p>Code type: DLLA136S1000 Nozzle type: Diesel</p>
<p>100471 Nozzle</p> 	<p>Servicing: Audi, Seat, Skoda, VW - Visit www.hc-cargo.com for further information</p>	<p>Code type: DN0SD297 Nozzle type: Diesel</p>
<p>100490 Nozzle</p> 	<p>Servicing: Nissan - Visit www.hc-cargo.com for further information</p>	
<p>100525 Nozzle</p> 		<p>Code type: DLLA150S720 Nozzle type: Diesel</p>
<p>100573 Nozzle</p> 		<p>Code type: DN10PDN130 Nozzle type: Diesel</p>
<p>SEALING RINGS</p>		
<p>080865 Sealing Ring</p> 		<p>ID: 8 mm OD: 16 mm Thickness: 1 mm</p> <p>Material: Steel/rubber</p>
<p>080866 Sealing Ring</p> 		<p>ID: 10 mm OD: 18 mm Thickness: 1.5 mm</p> <p>Material: Steel/rubber</p>

080868 Sealing Ring



ID: 14.7 mm
OD: 21 mm
Thickness: 1.5 mm

Material: Steel/rubber

THROTTLE SHAFTS

080188 Throttle Shaft

Servicing: CAV DPA - Visit www.hc-cargo.com for further information



Type/throttle shaft: Short

VE PUMP PARTS

090092 Repair Kit

Servicing: Bosch VE - Visit www.hc-cargo.com for further information

Turbo.



090165 Gasket Kit

Servicing: Bosch VE - Visit www.hc-cargo.com for further information



090212 Gasket Kit

Servicing: Bosch VE - Visit www.hc-cargo.com for further information



VE SUNDRY PARTS

080174 Plug

Servicing: VE Bosch



Material: Metal

VE THROTTLE SHAFTS

080828 Throttle Shaft

Servicing: Opel, Ford, VW - Visit www.hc-cargo.com for further information



Total length: 59.5 mm
Total height: 47.2 mm
Bottom o-ring: 26.7 mm
Top o-ring: 3 mm

GLOW PLUGS

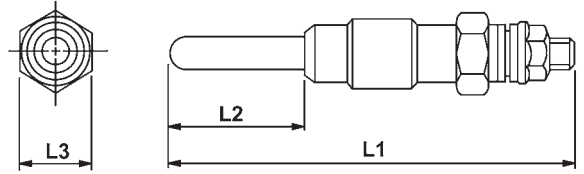

ITEM ID	Plug V	Battery	Ampere	Thread	L1	L2	L3	Glow duration
100079	0.9	12	6.3	M18-1.5	87.5 mm	27.5 mm	21 mm	SHP sec.
100086	11	12	10	M14-1.25	78 mm	28 mm	14 mm	<20 sec.
100177	11.5	12	13	UNF 7/8-14	62 mm	32 mm	24 mm	SHP sec.
100245	5	12	11	M10-1.25	89 mm	24 mm	12 mm	7-10 sec.
100246	12	12	8.5	M10-1.25	95 mm	22 mm	12 mm	<20 sec.
100247	11	12	9	M10-1.25	69 mm	19 mm	12 mm	<20 sec.
100251	11	12	8	M10-1.25	70 mm	19 mm	12 mm	7-10 sec.
100252	23	24	7.5	M10-1.25	70 mm	19 mm	12 mm	7-10 sec.
100254	10.5	12	6.5	M10-1.25	70 mm	19 mm	12 mm	7-10 sec.
100256	8.5	12	9	M10-1.25	103 mm	28 mm	12 mm	<20 sec.
100257	7	12	8.5	M10-1.25	101 mm	28 mm	12 mm	7-10 sec.
100258	7	12	8	M10-1.25	95 mm	31.5 mm	12 mm	7-10 sec.
100259	14	24	4.8	M10-1.25	101 mm	28 mm	12 mm	7-10 sec.
100260	11	12	11	M10-1.25	96 mm	31 mm	12 mm	<20 sec.
100261	10.5	12	16.5	M10-1.25	88 mm	22 mm	12 mm	7-10 sec.
100262	10.5	12	9	M18-1.5	87 mm	24 mm	21 mm	<40 sec.
100263	12	12	6	M10-1	97 mm	28 mm	15.9 mm	<15 sec.
100271	11	12	10	M10-1.25	68 mm	17 mm	12 mm	<10 sec.
100275	10.5	12	6.5	M10-1.25	87 mm	24 mm	12 mm	<20 sec.
100276	23	24	4.8	M10-1.25	67 mm	17 mm	12 mm	<10 sec.
100277	6	12	8	M10-1.25	95 mm	31.5 mm	12 mm	7-10 sec.
100280	20.5	24	5	M10-1.25	101 mm	28 mm	12 mm	<20 sec.
100282	23	24	4.6	M10-1.25	101 mm	28 mm	12 mm	<20 sec.
100283	11	12	10	M10-1.25	101 mm	28 mm	12 mm	<10 sec.
100284	11	12	10.5	M12-1.25	74 mm	29 mm	12 mm	7-10 sec.
100286	8.5	12	9	M10-1.25	86 mm	22 mm	12 mm	<20 sec.
100287	11	12	10	M10-1.25	88 mm	22 mm	12 mm	<10 sec.
100288	12	12	11	M10-1.25	86 mm	22 mm	12 mm	7-10 sec.
100291	11	12	6	M10-1.25	95 mm	32 mm	12 mm	<10 sec.
100292	11	12	6	M10-1.25	89 mm	24 mm	12 mm	<10 sec.
100295	9	12	15	M18-1.5	75 mm	28 mm	21 mm	7-10 sec.
100302	11	12	7	M10-1.25	83 mm	18.5 mm	12 mm	<10 sec.
100303	11	12	7	M12-1.25	66 mm	21 mm	12 mm	8 sec.
100306	10	12	9	M10-1.25	84 mm	20 mm	12 mm	5 sec.
100307	11.5	12	9	M10-1	125 mm	26.5 mm	12 mm	5 sec.
100310	11/6.2	12	14	M10-1.25	94 mm	20 mm	12 mm	5 sec.
100320	11	12	13	M10-1	81.25 mm	24 mm	10 mm	<7 sec.
100323	11	12	13	M10-1	79 mm	25 mm	12 mm	<7 sec.
100324	6.5	12	5.5	M10-1.25	84 mm	21.5 mm	12 mm	20 sec.
100325	6.5	12	5.5	M10-1.25	90 mm	21.5 mm	12 mm	20 sec.
100326	11	12	10	M10-1.25	95.1 mm	19 mm	12 mm	7 sec.
100327	11.5	12	14	M12-1.25	120.4 mm	27.5 mm	12 mm	8 sec.
100331	11.5	12	10	M12-1.25	67.6 mm	22 mm	12 mm	7 sec.
100335	11	12	9	M10-1.25	88.8 mm	28.5 mm	10 mm	7 sec.
100336	11	12	10	M10-1.25	82.4 mm	15.7 mm	12 mm	5 sec.
100337	11.5	12	10	M12-1.25	86 mm	28 mm	12 mm	4-9 sec.
100339	11.5	12	10	M12-1.25	115 mm	27.5 mm	12 mm	5 sec.
100426	11	12	7.2	M10-1.25	83 mm	17 mm	12 mm	7-10 sec.
100429	11	12	8-10	M10-1.25	103 mm	25 mm	12 mm	7-10 sec.
100432	11	12	8-10	M12-1.25	65.6 mm	25 mm	12 mm	6 sec.
100433	10.5	12	7.5	M10-1.25	70 mm	17 mm	12 mm	>20 sec.
100434	10.5	12	8	M10-1.25	75 mm	16 mm	12 mm	>20 sec.
100435	10.5	12	6.5	M10-1.25	74 mm	16 mm	12 mm	>25 sec.
100436	11	12	10	M10-1	92 mm	24 mm	10 mm	6 sec.
100510	11	12	7	M10-1.25	85 mm	17.5 mm	12 mm	7 sec.
100511	11	12	22	M12-1.25	71.5 mm	25 mm	12 mm	5 sec.
100512	11	12	22	M12-1.25	61 mm	20 mm	12 mm	7 sec.
100513	11	12	7	M10-1.25	89 mm	17.5 mm	12 mm	5 sec.

ITEM ID	Plug V	Battery	Ampere	Thread	L1	L2	L3	Glow duration
100514	11	12	6	M10-1.25	101 mm	28 mm	12 mm	10 sec.
100515	11	12	6	M10-1.25	86 mm	22 mm	12 mm	8-9 sec.
100516	11	12	5	M10-1.25	97 mm	32 mm	12 mm	8 sec.
100518	11	12	7.3	M8-1	69 mm	19.5 mm	10 mm	7 sec.
100520	11	12	6.5	M10-1.25	85 mm	22.5 mm	12 mm	6 sec.
100521	10.5	12	9.7	M10-1.25	83.5 mm	22 mm	12 mm	11 sec.
100522	10	12	10	M10-1.25	68 mm	17 mm	12 mm	6 sec.
100523	11	12	6	M10-1.25	80 mm	24.5 mm	12 mm	8.5 sec.
100524	11	12	6	M10-1.25	85 mm	30 mm	12 mm	8.5 sec.
100527	11	12	10	M10-1	97 mm	30 mm	10 mm	5 sec.
100529	11	12	8	M10-1	83 mm	25 mm	12 mm	5 sec.
100531	10	12	10	M12-1.25	62 mm	17.5 mm	12 mm	5 sec.
100532	10	12	8-10	M10-1	95 mm	24.5 mm	10 mm	6 sec.
100533	11	12	6-11	M10-1	107 mm	27.5 mm	10 mm	6 sec.
100534	11	12	8-10	M10-1	96.5 mm	24 mm	10 mm	5 sec.
100536	10.5	12	8-10	M10-1	106.4 mm	30 mm	10 mm	5 sec.
100537	11.5	12	10	M10-1	130.5 mm	27 mm	10 mm	8 sec.
100538	12	12	10	M10-1	126.5 mm	34.5 mm	10 mm	8 sec.
100540	10.5	12	10	M10-1	95.9 mm	27.5 mm	12 mm	8 sec.
100541	11	12	14	M12-1.25	69.4 mm	25 mm	12 mm	8 sec.
100544	11	12	10	M10-1	132.5 mm	28.5 mm	10 mm	8 sec.
100545	11	12	10	M12-1.25	70.1 mm	24.5 mm	12 mm	5 sec.
100547	11.5	12	10	M10-1.25	120.8 mm	30.8 mm	12 mm	5-7 sec.
100548	10.5	12	10	M10-1	77.5 mm	28.5 mm	10 mm	6 sec.
100555	11	12	10	M10-1.25	144.8 mm	23.3 mm	12 mm	5-6 sec.
100556	11	12	10	M10-1.25	170 mm	36.6 mm	12 mm	5-7 sec.
100557	11	12	10	M10-1.25	85.5 mm	17.3 mm	12 mm	5-7 sec.
100559	11	12	10	M10-1.25	67.6 mm	20.5 mm	12 mm	5-7 sec.
100560	11.5	12	10	M10-1.25	180 mm	20.9 mm	12 mm	5-6 sec.
100561	11.5	12	12	M10-1	180 mm	21.3 mm	12 mm	5-9 sec.
100562	11	12	10	M10-1.25	96 mm	22.5 mm	12 mm	5-7 sec.
100563	11	12	12	M10-1.25	88.5 mm	20.6 mm	12 mm	5-9 sec.
100565	10	12	10	M10-1	96.8 mm	25 mm	10 mm	5-10 sec.
100566	9.5	12	10	M14-2	100.5 mm	30 mm	14 mm	10> sec.
100578	11	12	10	M10-1.25	210 mm	23 mm	12 mm	10 sec.
100580	8	12	16	M22-1.5	64.5 mm	33 mm	24 mm	SHP sec.
100581	10.5	12	10	M10-1.25	81.1 mm	22.5 mm	12 mm	7 sec.
100583	10.5	12	14	M18-1.5	87.9 mm	25 mm	21 mm	20 sec.
100587	11.5	12	10	M10-1	150 mm	26 mm	8 mm	8 sec.
100590	11	12		M10-1.25	159 mm	36 mm	10 mm	
100592	11	12		M10-1	98.5 mm	24 mm	10 mm	
100593	11	12		M8-1	119 mm	27.5 mm	8 mm	
100594	11	12		M10-1	134 mm	30.5 mm	10 mm	
100595	11	12		10-1	111.5 mm	29.5 mm	10 mm	
100614	5	12		M10-1	81.5 mm	27 mm	3/8" mm	2-8 sec.
100616	11	12	10	M10-1	129.5 mm	31 mm	10 mm	8 sec.
100619	11	12	10	M10-1.25	82.9 mm	22 mm	12 mm	8 sec.
100622	11	12		M8-1	125.9 mm	24.5 mm	8 mm	3-6 sec.
100624	5	12	7	M8-1	118.5 mm	27 mm	8 mm	3-9 sec.
100625	4.4	12		M8-1	116.5 mm	29.5 mm	8 mm	4 sec.
100627	11	12		M8-1	118.9 mm	27.5 mm	8 mm	3-6 sec.
100634	10.5	12	7	M10-1.25	85 mm	22 mm	12 mm	
100636	10.5	12		10-1.25	76.5 mm	24.3 mm	12 mm	
100637	11	12		M10x1	150.4 mm	24 mm	10 mm	3-6 sec.
100639	11	12	16	M12-1.25	76 mm	21 mm	12 mm	7 sec.
100640	24	24		M12-1.25	61.4 mm	20 mm	12 mm	7.5 sec.
100641	5	12		M10-1	106 mm	32 mm	10 mm	4 sec.
100642	11	12		M9-1	150.9 mm	29.5 mm	9 mm	3-6 sec.
100644	11	12	10	M10-1.25	72.9 mm	24 mm	12 mm	8 sec.
100645	11	12	10	M10-1	103 mm	24 mm	10 mm	8 sec.
100646	11	12	10	M10-1	151 mm	24 mm	10 mm	8 sec.
100650	11	12	10	M12-1.25	71.9 mm	24.5 mm	12 mm	8 sec.
100651	11	12		M10-1.25	148.9 mm	31 mm	12 mm	8 sec.
100652	4.4	12		M8-1	147.9 mm	26.5 mm	8 mm	4 sec.
100653	11	12	10	M10-1	181.5 mm	21 mm	12 mm	8 sec.

GLOW PLUG RELAYS



ITEM ID	Pre-heating time in sec. at +20 °C	Post heating		Temp. Measurement		Characteristic	ITEM ID	Pre-heating time in sec. at +20 °C	Post heating		Temp. Measurement		Characteristic
		W/	W/o	Int.	Ext.				W/	W/o	Int.	Ext.	
160416	< 8		✓	✓			160444	< 9		✓	✓		w/ "defect" warning.
160417	< 13		✓	✓			160445	< 9	✓			✓	w/ "defect" warning.
160418	< 8	✓		✓			160446	< 9	✓			✓	w/ "defect" warning.
160419	< 6	✓		✓			160447	< 9	✓			✓	w/ "defect" warning.
160420	< 8	✓			✓		160448	< 9	✓			✓	w/ "defect" warning.
160421	< 4	✓			✓		160449	< 7	✓		✓		Can replace HC-CARGO 160441 and 160443 in connection w/ change to post heating glow plug.
160422	< 18		✓		✓		160451	< 7	✓			✓	
160423	< 14		✓	✓			160452		✓		✓		Technical specification on request.
160424	< 8		✓	✓			160453			✓			
160425	< 9		✓	✓			160458	< 12	✓			✓	
160426	< 7	✓		✓			160459			✓			Model UWD.
160431	< 10		✓	✓			160460						For engines w/ electronic diesel control.
160432	< 7	✓		✓			160461			✓			
160433	< 9	✓			✓		160464	< 5	✓			✓	For engines w/ electronic diesel control.
160434	< 8	✓			✓		160469	< 5	✓		✓		
160435	< 12	✓			✓		160718			✓			
160436	< 8	✓			✓		160719			✓			
160438	< 10	✓		✓			160795			✓			
160439	< 5	✓		✓									
160441	< 9		✓	✓		w/ "defect" warning.							
160442	< 9		✓	✓		w/ "defect" warning.							
160443	< 9		✓	✓		w/ "defect" warning.							

FANS & BLOWERS

BLOWERS

160513 Blower Servicing: Audi, Seat, VW - Visit www.hc-cargo.com for further information		
	Voltage: 12	No./shafts: 1 Fan mounted: Yes
160515 Blower Servicing: Audi, Seat, Skoda, VW - Visit www.hc-cargo.com for further information		
	Voltage: 12	No./shafts: 1 Fan mounted: Yes
160518 Blower Servicing: Citroen, Peugeot - Visit www.hc-cargo.com for further information		
	Voltage: 12	No./shafts: 1 Fan mounted: Yes
160520 Blower Servicing: VW, Audi - Visit www.hc-cargo.com for further information		
	Voltage: 12	No./shafts: 1 Fan mounted: Yes
160528 Blower Servicing: Honda - Visit www.hc-cargo.com for further information		
	Voltage: 12	No./shafts: 1 Fan mounted: Yes
160550 Blower Servicing: Ford - Visit www.hc-cargo.com for further information		
	Voltage: 12	No./shafts: 1 Fan mounted: Yes
160561 Blower Servicing: Peugeot - Visit www.hc-cargo.com for further information		
RHD. 	Voltage: 12	No./shafts: 1 Fan mounted: Yes

EL. SPECIFICATIONS	DIMENSIONS	ADDITIONAL SPECIFICATIONS
160590 Blower Servicing: Seat, VW - Visit www.hc-cargo.com for further information		
<i>RHD.</i> 	Voltage: 12	No./shafts: 1 Fan mounted: Yes
160591 Blower Servicing: VW - Visit www.hc-cargo.com for further information		
	Voltage: 12	No./shafts: 1 Fan mounted: Yes
160620 Blower Servicing: Audi, VW - Visit www.hc-cargo.com for further information		
<i>RHD.</i> 	Voltage: 12	No./shafts: 1 Fan mounted: Yes
160621 Blower Servicing: Audi, VW - Visit www.hc-cargo.com for further information		
	Voltage: 12	No./shafts: 1 Fan mounted: Yes
160631 Blower Servicing: Mercedes - Visit www.hc-cargo.com for further information		
	Voltage: 12	No./shafts: 1 Fan mounted: Yes
160710 Blower Servicing: Audi - Visit www.hc-cargo.com for further information		
	Voltage: 12	No./shafts: 1 Fan mounted: Yes
160767 Blower Servicing: Toyota Carina E, Avensis - Visit www.hc-cargo.com for further information		
	Voltage: 12	No./shafts: 1 Fan mounted: No

160768 Blower

Servicing: VW Golf, Seat - Visit www.hc-cargo.com for further information

w/ resistor.



Voltage: 12

No./shafts: 1
Fan mounted: Yes

160879 Blower

Servicing: GM, Opel, Saab - Visit www.hc-cargo.com for further information



Voltage: 12

No./shafts: 1
Fan mounted: Yes

CENTRIFUGAL TYPE

160483 Centrifugal Blower

Servicing: HC-CARGO 060216

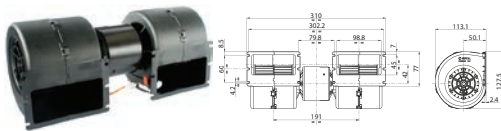

Voltage: 12
Amp: 15

Dim.: 113.1x127.5 mm
Shaft dia.: 50.1 mm
Length: 310 mm
Capacity: 750 m³
Pressure: 0 psi
Speed: 3-speed

No./shafts: 2
Fan mounted: Yes

160510 Centrifugal Blower

Servicing: New Holland tractors - Visit www.hc-cargo.com for further information

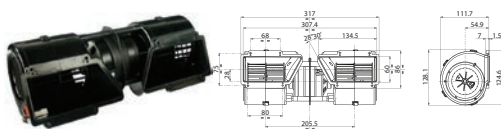

Voltage: 12
Amp: 14

Dim.: 111.7x124.6 mm
Shaft dia.: 54.9 mm
Length: 317 mm
Capacity: 650 m³
Pressure: 0 psi
Speed: 3-speed

No./shafts: 2
Fan mounted: Yes

160511 Centrifugal Blower

Servicing: Deutz, New Holland

This model have to be used w/ a static pressure that is higher than 0.1 psi. (pressure cabins).

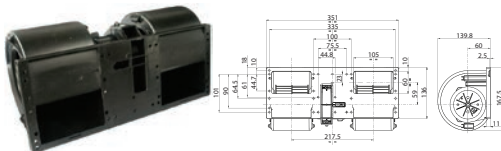

Voltage: 12
Amp: 34

Dim.: 139.8x167.5 mm
Shaft dia.: 60 mm
Length: 351 mm
Capacity: 840 m³
Pressure: 0 psi
Speed: 1-speed









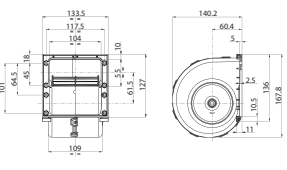

No./shafts: 2
Fan mounted: Yes

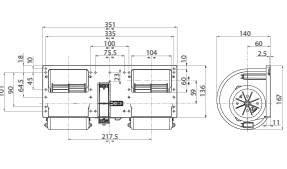

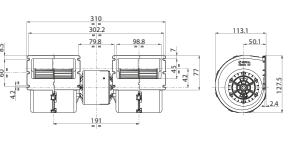

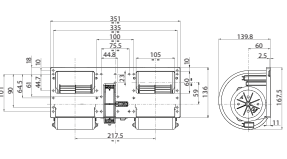

160512 Centrifugal Blower

Voltage: 24
Amp: 15.9

Dim.: 139.8x167.5 mm
Shaft dia.: 60 mm
Length: 351 mm
Capacity: 1160 m³
Pressure: 0 psi
Speed: 3-speed

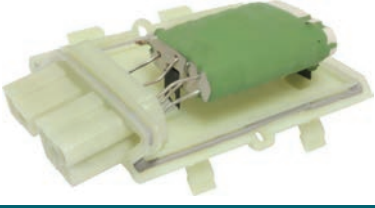
No./shafts: 2
Fan mounted: Yes

	EL. SPECIFICATIONS	DIMENSIONS	ADDITIONAL SPECIFICATIONS
160639 Centrifugal Blower  	Voltage: 12 Amp: 19.9	Dim.: 140.2x167.8 mm Shaft dia.: 60.4 mm Length: 133.5 mm Capacity: 510 m ³ Pressure: 0 psi Speed: 3-speed	No./shafts: 1 Fan mounted: Yes
160647 Centrifugal Blower  	Voltage: 12 Amp: 17.2	Dim.: 140x167 mm Shaft dia.: 60 mm Length: 351 mm Capacity: 910 m ³ Speed: 3-speed	No./shafts: 2 Fan mounted: Yes
160649 Centrifugal Blower  	Voltage: 24 Amp: 8.2	Servicing: HC-CARGO 060220 Dim.: 113.1x127.5 mm Shaft dia.: 50.1 mm Length: 310 mm Capacity: 750 m ³ Pressure: 0 psi Speed: 3-speed	No./shafts: 2 Fan mounted: Yes
160878 Centrifugal Blower  	Voltage: 24 Amp: 12	Servicing: Volvo - Visit www.hc-cargo.com for further information Dim.: 139.8x167.5 mm Shaft dia.: 60 mm Length: 351 mm Capacity: 1050 m ³ Pressure: 0 psi Speed: 4-speed	No./shafts: 2 Fan mounted: Yes
BLOWER RESISTORS			
160548 Resistor 	Servicing: Opel, Saab, Vauxhall - Visit www.hc-cargo.com for further information		Connection: 4+2 Type: 3-speed
160549 Resistor 	Servicing: Opel, Vauxhall - Visit www.hc-cargo.com for further information		Connection: 5+2 Type: 4-speed
160565 Resistor 	Servicing: Citroën, Peugeot - Visit www.hc-cargo.com for further information		Connection: 4+1+1

	EL. SPECIFICATIONS	DIMENSIONS	ADDITIONAL SPECIFICATIONS
160760 Resistor 	Servicing: Audi, Seat, VW - Visit www.hc-cargo.com for further information		Connection: 4
160762 Resistor 	Servicing: VW - Visit www.hc-cargo.com for further information		Connection: 4
160763 Resistor <i>For cars w/o air condition.</i> 	Servicing: VW - Visit www.hc-cargo.com for further information		Connection: 8
160764 Resistor 	Servicing: VW - Visit www.hc-cargo.com for further information		Connection: 5+2
160765 Resistor 	Servicing: BMW - Visit www.hc-cargo.com for further information		Connection: 5
160794 Blower Resistor 	Servicing: Mercedes-Benz - Visit www.hc-cargo.com for further information		Connection: 4
FAN/HEATER MOTORS			
UNIVERSAL			
SINGLE SHAFTS			
160005 Universal Motor <i>Universal.</i> 	Voltage: 12 Watt: 40	Dia.: 60 mm Shaft dia.: 8x22 mm Length: 121 mm Revolutions/min.: 2000 Speed: 1-speed	No./shafts: 1 Fan mounted: No

160006 Universal Motor
Universal.

 Voltage: 24
Watt: 40

 Dia.: 60 mm
Shaft dia.: 8x22 mm
Length: 121 mm
Revolutions/min.: 2000
Speed: 1-speed

 No./shafts: 1
Fan mounted: No

160674 Universal Motor
Universal.

Voltage: 12

 Dim.: 58x107 mm
Dia.: 51 mm
Shaft dia.: 5 mm
Length: 107 mm

 No./shafts: 1
Fan mounted: No

160734 Universal motor

 Servicing: Volvo - Visit www.hc-cargo.com for further information

Voltage: 12

 Dia.: 73 mm
Shaft dia.: 8 mm
Length: 144 mm

 No./shafts: 1
Fan mounted: No

DOUBLE SHAFTS
160250 Universal Motor
Universal.

Voltage: 12

 Dia.: 90 mm
Shaft dia.: 10x110 mm
Length: 105 mm
Revolutions/min.: 3200
Speed: 3-speed

 No./shafts: 2
Fan mounted: No

160251 Universal Motor
Universal.

Voltage: 24

 Dia.: 90 mm
Shaft dia.: 7.95x79 mm
Length: 107 mm
Revolutions/min.: 2600
Speed: 3-speed

 No./shafts: 2
Fan mounted: No

160252 Universal Motor
Universal.

Voltage: 24

 Dia.: 82 mm
Shaft dia.: 7.2x58 mm
Length: 248 mm
Revolutions/min.: 2500
Speed: 1-speed

 No./shafts: 2
Fan mounted: No

160253 Universal Motor
Universal.

Voltage: 12

 Dia.: 77.5 mm
Shaft dia.: 7x68.5 mm
Length: 254 mm
Revolutions/min.: 3300
Speed: 3-speed

 No./shafts: 2
Fan mounted: No

160622 DC Motor

Servicing: Massey Ferguson 3070 - Visit www.hc-cargo.com for further information

Universal.



Voltage: 12

Dia.: 73 mm
 Shaft dia.: 8x51 mm
 Length: 223 mm
 Revolutions/min.: 3100

Type: Blower
 No./shafts: 2
 Fan mounted: No

160626 DC Motor

Servicing: Fiat tractors - Visit www.hc-cargo.com for further information

Universal.



Voltage: 12

Dia.: 59.5 mm
 Shaft dia.: 8 mm
 Length: 198 mm
 Revolutions/min.: 4000

No./shafts: 2
 Fan mounted: No

AXIAL FANS

12 V

160536 Axial Fan

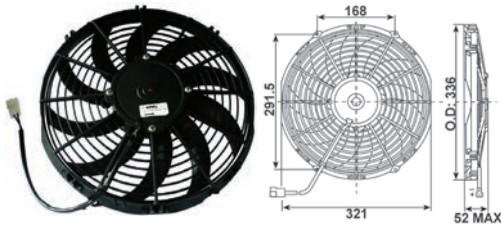

Voltage: 12
 Amp: 6.2

Capacity: 1590 m³
 OD: 336 mm

Type: Blower
 Fan mounted: Yes
 Tightness norm: IP 68

160537 Axial Fan

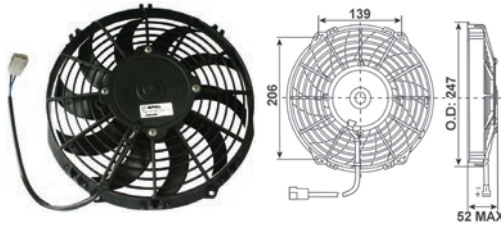

Voltage: 12
 Amp: 6.7

Capacity: 1060 m³
 OD: 247 mm

Type: Suction
 Fan mounted: Yes
 Tightness norm: IP 68

160538 Axial Fan

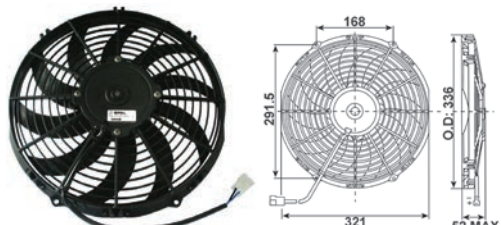

Voltage: 12
 Amp: 6.7

Capacity: 1540 m³
 OD: 336 mm

Type: Suction
 Fan mounted: Yes
 Tightness norm: IP 68

160539 Axial Fan

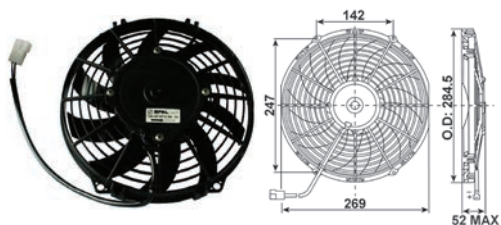

Voltage: 12
 Amp: 8.7

Capacity: 1360 m³
 OD: 284.5 mm

Type: Suction
 Fan mounted: Yes
 Tightness norm: IP 68

	EL. SPECIFICATIONS	DIMENSIONS	ADDITIONAL SPECIFICATIONS
<p>160598 Axial Fan</p>	<p>Voltage: 12 Amp: 7.8</p>	<p>Capacity: 1390 m³ OD: 310 mm</p>	<p>Type: Suction Fan mounted: Yes Tightness norm: IP 68</p>
<p>160601 Axial Fan</p>	<p>Voltage: 12 Amp: 7.7</p>	<p>Capacity: 1400 m³ OD: 310 mm</p>	<p>Type: Blower Fan mounted: Yes Tightness norm: IP 68</p>
<p>160739 Axial Fan</p>	<p>Voltage: 12 Amp: 15.6</p>	<p>Capacity: 2430 m³ OD: 331 mm</p>	<p>Type: Suction Fan mounted: Yes Tightness norm: IP 68</p>
<p>160885 Axial Fan</p>	<p>Voltage: 12 Amp: 12.7</p>	<p>Capacity: 2390 m³ Dim.: 376x310x108 mm OD: 292 mm</p>	<p>Type: Suction Fan mounted: Yes Tightness norm: IP 68</p>
<p>160910 Axial Fan</p>	<p>Voltage: 12 Amp: 7.2</p>	<p>Capacity: 1080 m³ OD: 247 mm</p>	<p>Type: Blower Fan mounted: Yes Tightness norm: IP 68</p>
<p>160911 Axial Fan</p>	<p>Voltage: 12 Amp: 7.6</p>	<p>Capacity: 1430 m³ OD: 284.5 mm</p>	<p>Type: Blower Fan mounted: Yes Tightness norm: IP 68</p>

	EL. SPECIFICATIONS	DIMENSIONS	ADDITIONAL SPECIFICATIONS
160912 Axial Fan 	Voltage: 12 Amp: 11.4	Capacity: 2280 m ³ Dim.: 376x310x108 mm OD: 292 mm	Type: Blower Fan mounted: Yes Tightness norm: IP 68
160913 Axial Fan 	Voltage: 12 Amp: 15.3	Capacity: 2340 m ³ OD: 331 mm	Type: Blower Fan mounted: Yes Tightness norm: IP 68
160914 Axial Fan 	Voltage: 12 Amp: 9.5	Capacity: 2220 m ³ OD: 382 mm	Type: Suction Fan mounted: Yes Tightness norm: IP 68
160915 Axial Fan 	Voltage: 12 Amp: 8.7	Capacity: 2140 m ³ OD: 382 mm	Type: Blower Fan mounted: Yes Tightness norm: IP 68
161000 HC-CARGO Axial Fan 	Voltage: 12 Amp: 9	Capacity: 1506 m ³ OD: 284.6 mm	Type: Suction Tightness norm: IP 68
161002 HC-CARGO Axial Fan 	Voltage: 12 Amp: 7.5	Capacity: 1733 m ³ OD: 335.6 mm	Type: Suction Tightness norm: IP 68

	EL. SPECIFICATIONS	DIMENSIONS	ADDITIONAL SPECIFICATIONS
161003 HC-CARGO Axial Fan			
	Voltage: 12 Amp: 7.5	Capacity: 1733 m ³ OD: 335.5 mm	Type: Blower Tightness norm: IP 68
24 V			
160584 Axial Fan			
	Voltage: 24 Amp: 7.4	Capacity: 2900 m ³ OD: 331 mm	Type: Suction Fan mounted: Yes Tightness norm: IP 68
160587 Axial Fan			
	Voltage: 24 Amp: 3.9	Capacity: 1300 m ³ OD: 284.5 mm	Type: Suction Tightness norm: IP 68
160588 Axial Fan			
	Voltage: 24 Amp: 4.1	Capacity: 1080 m ³ OD: 247 mm	Type: Blower Fan mounted: Yes Tightness norm: IP 68
160595 Axial Fan			
	Voltage: 24 Amp: 8.7	Capacity: 3540 m ³ OD: 414 mm	Type: Blower Tightness norm: IP 68
160597 Axial Fan			
	Voltage: 24 Amp: 3.9	Capacity: 1180 m ³ OD: 336 mm	Type: Blower Fan mounted: Yes Tightness norm: IP 68

	EL. SPECIFICATIONS	DIMENSIONS	ADDITIONAL SPECIFICATIONS
160599 Axial Fan 	Voltage: 24 Amp: 4.4	Capacity: 1690 m ³ OD: 310 mm	Type: Suction Fan mounted: Yes Tightness norm: IP 68
160600 Axial Fan 	Voltage: 24 Amp: 4.1	Capacity: 1570 m ³ OD: 310 mm	Type: Blower Tightness norm: IP 68
160619 Axial Fan 	Voltage: 24 Amp: 7.8	Capacity: 2440 m ³ OD: 331 mm	Type: Blower Fan mounted: Yes Tightness norm: IP 68
160714 Axial Fan 	Voltage: 24 Amp: 3.7	Capacity: 1400 m ³ OD: 284.5 mm	Type: Blower Tightness norm: IP 68
160737 Axial Fan 	Voltage: 24 Amp: 6	Capacity: 2240 m ³ OD: 336 mm	Type: Blower Fan mounted: Yes Tightness norm: IP 68
160777 Axial Fan 	Voltage: 24 Amp: 8.4	Capacity: 3315 m ³ OD: 414 mm	Type: Suction Tightness norm: IP 68

	EL. SPECIFICATIONS	DIMENSIONS	ADDITIONAL SPECIFICATIONS
160799 Axial Fan 	Voltage: 24 Amp: 4	Capacity: 1170 m ³ OD: 247 mm	Type: Suction Fan mounted: Yes Tightness norm: IP 68
160906 Axial Fan 	Voltage: 24 Amp: 3.7	Capacity: 1070 m ³ OD: 247 mm	Type: Suction Fan mounted: Yes Tightness norm: IP 68
160907 Axial Fan 	Voltage: 24 Amp: 5.7	Capacity: 1990 m ³ OD: 278 mm	Type: Suction Fan mounted: Yes Tightness norm: IP 68
160908 Axial Fan 	Voltage: 24 Amp: 7.1	Capacity: 2760 m ³ OD: 331 mm	Type: Blower Fan mounted: Yes Tightness norm: IP 68
160909 Axial Fan 	Voltage: 24 Amp: 4.9	Capacity: 2170 m ³ OD: 382 mm	Type: Suction Fan mounted: Yes Tightness norm: IP 68
160998 HC-CARGO Axial Fan 	Voltage: 24 Amp: 2.5	Capacity: 645 m ³ OD: 210.8 mm	Type: Suction Tightness norm: IP68

	EL. SPECIFICATIONS	DIMENSIONS	ADDITIONAL SPECIFICATIONS
160999 HC-CARGO Axial Fan			
	Voltage: 24 Amp: 2.5	Capacity: 645 m ³ OD: 210.8 mm	Type: Blower Tightness norm: IP68
161001 HC-CARGO Axial Fan			
	Voltage: 24 Amp: 4	Capacity: 1437 m ³ OD: 284.6 mm	Type: Suction Tightness norm: IP 68
161004 HC-CARGO Axial Fan			
	Voltage: 24 Amp: 9	Capacity: 2976 m ³ OD: 330.6 mm	Type: Suction Tightness norm: IP 68
ACCESSORIES			
160966 Mounting kit			
		Total length: 180 mm	Washer: w/
CABIN HEATERS			
060210 Cabin Heater			
<i>w/ tube connection and switch.</i>			
	Voltage: 12 Watt/speed 1: 50	Dim.: 195x172x150 mm Water connection OD: 16 mm Weight: 3 kg Capacity kW/speed 1: 5.5 Airflow speed 1: 273 m ³ /h Capacity kW/speed 2: 6 Airflow speed 2: 360 m ³ /h Regulation: Yes	Type: Complete kit Cabinet: Steel
060211 Cabin Heater			
<i>w/ tube connection and switch.</i>			
	Voltage: 24 Watt/speed 1: 50	Dim.: 195x172x150 mm Water connection OD: 16 mm Weight: 3 kg Capacity kW/speed 1: 5.5 Airflow speed 1: 273 m ³ /h Capacity kW/speed 2: 6 Airflow speed 2: 360 m ³ /h Regulation: Yes	Type: Complete kit Cabinet: Steel

060216 Cabin Heater

The heater has three 75 mm tube connections on the air inlet side. There are also three 75 mm tube connections on the outlet side. The water connections can be placed on either side of the heater and also be turned towards either the inlet or the outlet side.

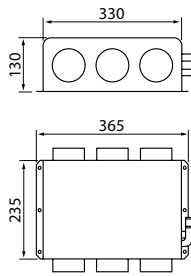

Voltage: 12
Watt/speed 1: 60
Watt/speed 2: 77
Watt/speed 3: 114

Dim.: 330x230x130 mm
Water connection OD: 16 mm
Weight: 6.3 kg
Capacity kW/speed 1: 7.2
Airflow speed 1: 264 m³/h
Capacity kW/speed 2: 9.3
Airflow speed 2: 357 m³/h
Capacity kW/speed 3: 12.2
Airflow speed 3: 504 m³/h
Regulation: Yes

Type: Complete kit
Cabinet: Stainless steel

060220 Cabin Heater

The heater has three 75 mm tube connections on the air inlet side. There are also three 75 mm tube connections on the outlet side. The water connections can be placed on either side of the heater and also be turned towards either the inlet or the outlet side. Blower: HC-CARGO 160649.

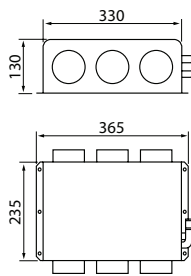

Voltage: 24
Watt/speed 1: 60
Watt/speed 2: 77
Watt/speed 3: 114

Dim.: 330x230x130 mm
Water connection OD: 16 mm
Weight: 6.3 kg
Capacity kW/speed 1: 7.2
Airflow speed 1: 264 m³/h
Capacity kW/speed 2: 9.2
Airflow speed 2: 357 m³/h
Capacity kW/speed 3: 12.2
Airflow speed 3: 504 m³/h
Regulation: Yes

Type: Complete kit
Cabinet: Stainless steel

060222 Cabin Heater

This Cabin heater is easily installed in small off road vehicles or as auxiliary heater in buses and delivery vans. The heating cycle is controlled by means of the built-in 1/4-turn water valve and the built-in switch. Heat-On 1331-12.

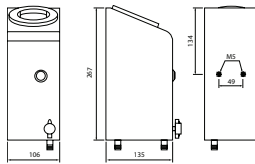

Voltage: 12
Watt/speed 1: 24

Dim.: 267x106x135 mm
Water connection OD: 12 mm
Weight: 3 kg
Capacity kW/speed 1: 1.9
Airflow speed 1: 76 m³/h
Regulation: No

Type: Complete kit
Cabinet: Metal

060223 Cabin Heater

This very powerful cabin heater is used for airrecirculation and has all connections behind a cover allowing hoses and cables to be led in any direction. It has a powerful fan (230 W), controlled by means of a built-in 1/4-turn water valve. Efficient distribution of the air through the adjustable air vents provides for demisting of the cabin screens w/o the use of extra tubes and nozzles.

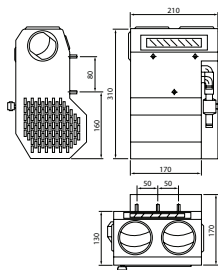

Voltage: 12
Watt/speed 3: 230

Dim.: 310x210x130 mm
Water connection OD: 16 mm
Weight: 5.8 kg
Capacity kW/speed 1: 4.3
Airflow speed 1: 180 m³/h
Capacity kW/speed 2: 6.3
Airflow speed 2: 288 m³/h
Capacity kW/speed 3: 9.2
Airflow speed 3: 468 m³/h
Regulation: Yes

Type: Complete kit
Cabinet: Galvanized steel w/ black polyester

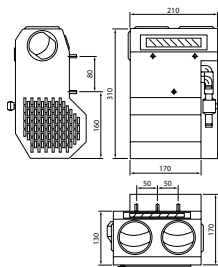
060233 Cabin Heater

Voltage: 24
Watt/speed 3: 230

Dim.: 310x210x130 mm
Water connection OD: 16 mm
Weight: 5.8 kg
Capacity kW/speed 1: 4.3
Airflow speed 1: 180 m³/h
Capacity kW/speed 2: 6.3
Airflow speed 2: 288 m³/h
Capacity kW/speed 3: 9.2
Airflow speed 3: 468 m³/h
Regulation: Yes

Type: Complete kit
Cabinet: Galvanized steel w/ black polyester

060235 Cabin Heater

Especially suitable for heating the passenger room in for instance buses.

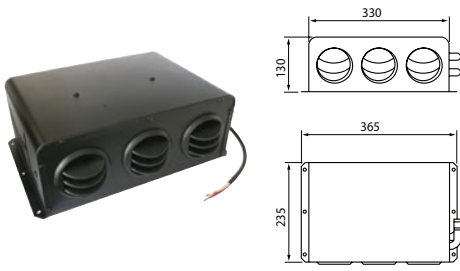

Voltage: 24
Watt/speed 1: 60
Watt/speed 2: 77
Watt/speed 3: 114

Dim.: 365x235x130 mm
Water connection OD: 16 mm
Weight: 6.3 kg
Capacity kW/speed 1: 7.2
Airflow speed 1: 264 m³/h
Capacity kW/speed 2: 9.3
Airflow speed 2: 357 m³/h
Capacity kW/speed 3: 12.2
Airflow speed 3: 504 m³/h
Regulation: Yes

Type: Complete kit
Cabinet: Metal

060241 Cabin Heater

Servicing: Delivery vans, excavators, park tractors - Visit www.hc-cargo.com for further information

Radiator: copper/aluminium.



Voltage: 12
Watt/speed 2: 75

Dim.: 273x114x199 mm
Water connection OD: 16 mm
Weight: 1.7 kg
Capacity kW/speed 2: 4.3
Airflow speed 2: 230 m³/h
Regulation: Yes

Type: Complete kit
Cabinet: Shockproof plastic

HEATER MOTORS

060059 Cabin Heater Motor

Heat-on 1531M-2412.



Voltage: 12
Watt: 24

Dim.: 72 mm
Dia.: 70 mm
Shaft dia.: 6.35x16 mm
Length: 63 mm
Speed: 1-speed

Mount.: 3 holes
No./shafts: 1

060213 Cabin Heater Motor

Servicing: HC-CARGO 060210

Heat-on 1531M-5012.



Voltage: 12
Watt: 50

Dia.: 70 mm
Shaft dia.: 6.35x16 mm
Length: 63 mm
Speed: 2-speed

Mount.: 3 holes
No./shafts: 1
Fan mounted: Yes

060214 Cabin Heater Motor

Servicing: HC-CARGO 060211

Heat-on 1531M-5024.



Voltage: 24
Watt: 50

Dia.: 70 mm
Shaft dia.: 6.35x16 mm
Length: 63 mm
Speed: 1-speed

Mount.: 3 holes
No./shafts: 1
Fan mounted: Yes

CONNECTORS

060229 Round Air Vent

Heat-on 66231.



ID: 70/76 mm
OD: 101 mm

ACCESSORIES

060058 Defroster Set

Servicing: HC-CARGO 060210, 060211

Heat-on 1518.

 ID/demister tube connection: 45 mm
 ID/demister tube: 40 mm
 Demister tube length: 160 cm

 Rubber elbows: 2
 Demister nozzles: 2

060219 Air Distribution Kit

Servicing: HC-CARGO 060216, 060220

Heat-on 3050-30.

 ID/demister tube: 75 mm
 Demister tube length: 620 cm

Demister nozzles: 3

060227 Water Valve

Heat-on 2100.

 ID/demister tube connection: 16 mm
 Demister tube length: 11.2 cm

060237 Demister Tube

ID/demister tube: 50 mm

WIPER SYSTEMS

WIPER BLADES

FOR PASSENGER CARS

CARGO FLEXIBLE

161399 Wiper Blades display flex

Servicing: HC-CARGO Flexible

Width: 70 cm.

	HC-CARGO	Length		Type
	161400	400 mm	16"	For curved glass
	161425	425 mm	17"	For curved glass
	161450	450 mm	18"	For curved glass
	161480	480 mm	19"	For curved glass
	161500	500 mm	20"	For curved glass
	161530	530 mm	21"	For curved glass
	161550	550 mm	22"	For curved glass
	161600	600 mm	24"	For curved glass
	161650	650 mm	26"	For curved glass
	161700	700 mm	28"	For curved glass

STANDARD TYPE

160586 Wiper Blade Display

Servicing: Passenger cars - Visit www.hc-cargo.com for further information

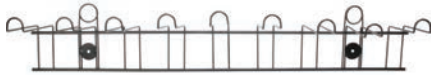

	HC-CARGO	Length	
	160628	280 mm	11"
	160633	330 mm	13"
	160635	350 mm	14"
	160638	380 mm	15"
	160641	410 mm	16"
	160643	430 mm	17"
	160645	450 mm	18"
	160648	480 mm	19"
	160650	500 mm	20"
	160653	530 mm	21"
	160655	550 mm	22"
	160661	610 mm	24"
	161580	580 mm	23"

SPOILER

	HC-CARGO	Length	
	160741	400 mm	16"
	160745	450 mm	18"
	160748	480 mm	19"
	160750	510 mm	20"
	160753	530 mm	22"
	160755	550 mm	22"
	160761	610 mm	24"
	160766	660 mm	26"
	160771	710 mm	28"

FOR TRUCKS

	HC-CARGO	Length	
	160321	400 mm	16"
	160322	450 mm	18"
	160323	500 mm	20"
	160325	600 mm	24"
	160326	600 mm	24"
	160327	650 mm	26"
	160328	700 mm	28"
	160329	800 mm	32"
	160330	1000 mm	40"
	160370	650 mm	26"
	160411	700 mm	28"
	161013	900 mm	36"

INDUSTRIAL

	HC-CARGO	Length		Type
	160019	300 mm	12"	For flat glass
	160025	360 mm	14"	For flat glass
	160026	400 mm	16"	For flat glass
	160028	330 mm	13"	For flat glass
	160035	350 mm	14"	For flat glass

MOUNTING PARTS
160727 K-Connector

Servicing: HC-CRGO 160338



Used on: Trucks

160758 Adapter Kit

Servicing: HC-CARGO 160325



Used on: Trucks

WIPER ARMS
160022 Wiper Arm

 Dim./wiper arm: 8x2 mm
 Length: 390 mm
 Mount./wiper shaft: 6 mm

Type: Single

160023 Wiper Arm

 Servicing: Opel - Visit www.hc-cargo.com for further information

 Dim./wiper arm: 8x2 mm
 Length: 420 mm
 Mount./wiper shaft: 6 mm

Type: Single

160024 Wiper Arm

 Servicing: Opel - Visit www.hc-cargo.com for further information

 Dim./wiper arm: 8x2.5 mm
 Length: 450 mm
 Mount./wiper shaft: 6 mm

Type: Single

160256 Wiper Arm

Wiper motor: HC-CARGO 160258, 160290, 160291, 160357, 160408.

 Length: 450 mm
 Dist./wiper arms: 57 mm
 Mount./wiper shaft: M6
 cone + M8 shaft mm







 Type: Parallel
 Length/adjustable: No

160257 Wiper Arm

Usable w/ HC-CARGO 160258, 160290, 160291, 160357, 160408.

 Length: 400 mm
 Dist./wiper arms: 57 mm
 Mount./wiper shaft: M6
 cone + M8 shaft mm

 Type: Parallel
 Length/adjustable: No

EL. SPECIFICATIONS		DIMENSIONS	ADDITIONAL SPECIFICATIONS
160338 Wiper Arm Servicing: HC-CARGO 160727 <i>Usable w/ wiper motor: HC-CARGO 160340, 160345.</i>			
		Length: 700 mm Dist./wiper arms: 55 mm Mount./wiper shaft: 2x8 cone mm	Type: Parallel Length/adjustable: No
160339 Wiper Arm <i>Wiper motor: HC-CARGO 160292, 106293.</i>			
		Length: 400 mm Dist./wiper arms: 57 mm Mount./wiper shaft: 6+M8 shaft mm	Type: Parallel Length/adjustable: No
160358 Wiper Arm <i>Wiper motor: HC-CARGO 160258, 160290, 160291, 160357, 160408.</i>			
		Length: 500 mm Dist./wiper arms: 57 mm Mount./wiper shaft: M6 cone + M8 shaft mm	Type: Parallel Length/adjustable: No
160359 Wiper Arm <i>Wiper motor: HC-CARGO 160258, 160290, 160291, 160357, 160408.</i>			
		Length: 550 mm Dist./wiper arms: 57 mm Mount./wiper shaft: M6 cone + M8 shaft mm	Type: Parallel Length/adjustable: No
160484 Wiper Arm <i>Usable w/ HC-CARGO 160258, 160480.</i>			
		Length: 340-420 mm Dist./wiper arms: 57 mm Mount./wiper blade: 9x2.5 mm hook Mount./wiper shaft: M8 cone + M8 shaft mm	Type: Parallel Length/adjustable: Yes
160485 Wiper Arm			
		Length: 430-500 mm Dist./wiper arms: 57 mm Mount./wiper blade: 9x2.5 mm hook Mount./wiper shaft: M8 cone + M8 shaft mm	Type: Parallel Length/adjustable: Yes
160486 Wiper Arm			
		Length: 340-420 mm Mount./wiper blade: 9x3 mm hook Mount./wiper shaft: M8 cone mm	Type: Single Length/adjustable: Yes

160487 Wiper Arm

Length: 430-500 mm
Mount./wiper blade:
9x3 mm hook
Mount./wiper shaft: M8
cone mm

Type: Single
Length/adjustable: Yes

160571 Wiper Arm

Length: 680 mm
Dist./wiper arms: 60 mm
Mount./wiper shaft:
2x8 cone mm

Type: Parallel
Length/adjustable: No

WIPER MOTORS
160150 Wiper Motor

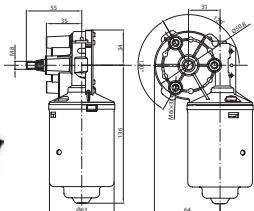
 Servicing: Fiat 127, Lada 2101 - Visit www.hc-cargo.com for further information

Voltage: 12

Type: OE

160376 Wiper Motor

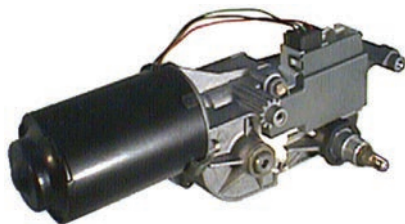
 Servicing: Fiat Uno - Visit www.hc-cargo.com for further information

Voltage: 12

Type: OE
Position: Front windscreen
Wiper shaft: w/ 1 Shaft
Built in switch: Yes
Auto stop: Yes

160395 Wiper Motor

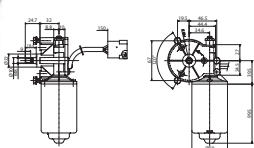
 Servicing: Nissan Patrol 86-93 - Visit www.hc-cargo.com for further information

Voltage: 12

Type: OE
Position: Rear windscreen
Wiper shaft: M/ 1 M8 aksel
Auto stop: No

160396 Wiper Motor

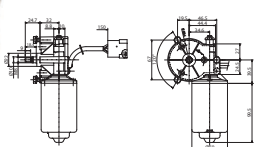
 Servicing: Nissan Patrol 86-93 - Visit www.hc-cargo.com for further information

Voltage: 24

Type: OE
Position: Rear windscreen
Wiper shaft: M/ 1 M8 aksel
Auto stop: No

160671 Wiper Motor

 Servicing: Citroen, Fiat, Peugeot - Visit www.hc-cargo.com for further information

Voltage: 12

Type: OE
Position: Front windscreen

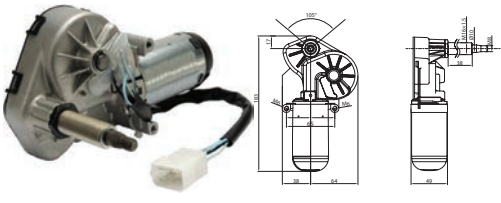
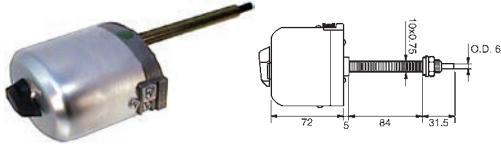
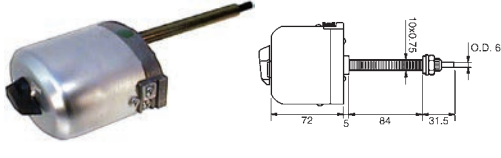
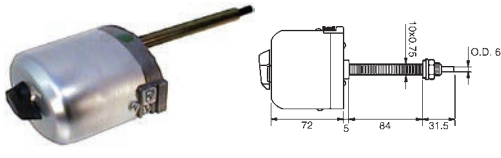
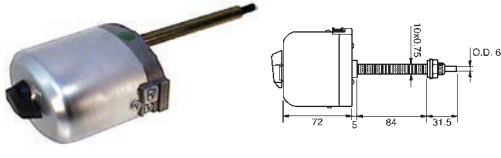
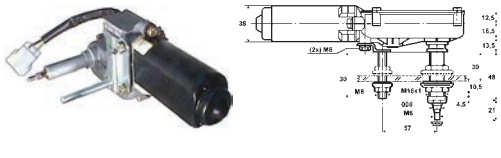
	EL. SPECIFICATIONS	DIMENSIONS	ADDITIONAL SPECIFICATIONS
160881 Wiper Motor 	Servicing: TEREX/SCHAEFF 5388665196 Voltage: 12		Type: OE Wiper shaft: w/ 1 Shaft Built in switch: No Auto stop: Yes Auto stop/placement: Left side
UNIVERSAL			
160031 Wiper Motor <i>Fitted w/ an interchangeable bearing allowing the shaft to be cut in any size.</i> 	Voltage: 12	Wiper angle: 85°	Type: Universal Built in switch: Yes Auto stop: No
160032 Wiper Motor <i>Fitted w/ an interchangeable bearing allowing the shaft to be cut in any size.</i> 	Voltage: 24	Wiper angle: 85°	Type: Universal Built in switch: Yes Auto stop: No
160033 Wiper Motor <i>Fitted w/ an interchangeable bearing allowing the shaft to be cut in any size.</i> 	Voltage: 12	Wiper angle: 110°	Type: Universal Built in switch: Yes Auto stop: No
160034 Wiper Motor <i>Fitted w/ an interchangeable bearing allowing the shaft to be cut in any size.</i> 	Voltage: 24	Wiper angle: 110°	Type: Universal Built in switch: Yes Auto stop: Yes
160258 Wiper Motor <i>w/ reciprocating shaft.</i> 	Voltage: 12	Dist./shafts: 57 mm Wiper angle: 95°	Type: Universal Wiper shaft: w/ 2 shafts for parallelogram Built in switch: No Auto stop: Yes

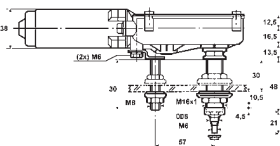
160725 Wiper Motor

Voltage: 12

 Dist./shafts: 57 mm
 Wiper angle: 90°

 Type: Universal
 Wiper shaft: w/ 2 M8 shafts for parallelogram
 Built in switch: Yes
 Auto stop: Yes
 Auto stop/placement: Right side

WINDSCREEN WASHERS
KITS
160186 Washer Kit

Pump: HC-CARGO 160386.



Voltage: 12

 Can capacity: 1.2 l
 Capacity: 140 ml/min
 Dim.: 190x130x100 mm

 Type: Complete kit
 Can: w/

160273 Washer Kit

Pump: HC-CARGO 160630.



Voltage: 24

 Can capacity: 1.2 l
 Dim.: 190x130x100 mm

 Type: Complete kit
 Can: w/

TANKS
12 V
160187 Washer Tank

Washer pump: HC-CARGO 160360.



Voltage: 12

 Can capacity: 3 l
 Dim.: 207x200x100 mm

 Type: Can
 Motor: w/

160973 Washer Tank 12 V

Washer pump: HC-CARGO 160386.



Voltage: 12

 Can capacity: 1.2 l
 Dim.: 190x130x100 mm

 Type: Can
 Motor: w/

24 V
160188 Washer Tank

Washer pump: HC-CARGO 160360.











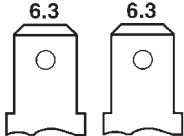
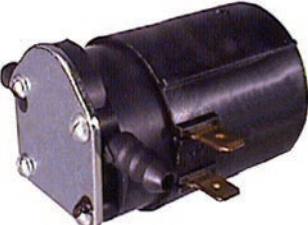
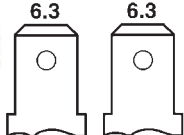

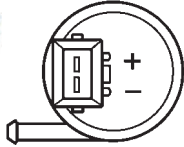

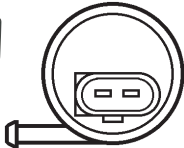

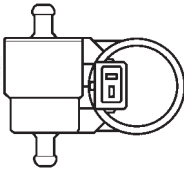

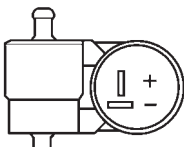
Voltage: 24

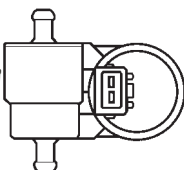

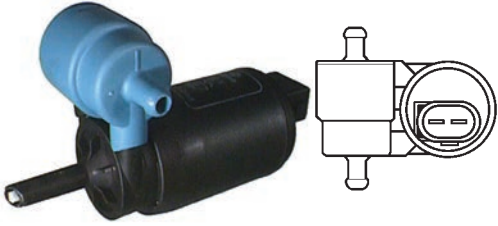

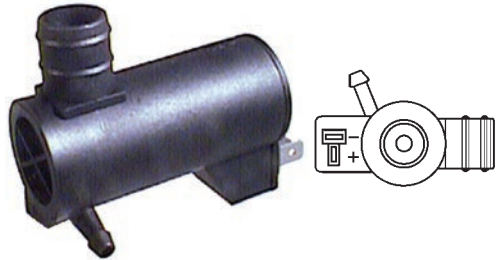

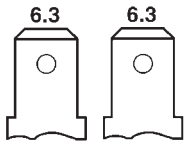
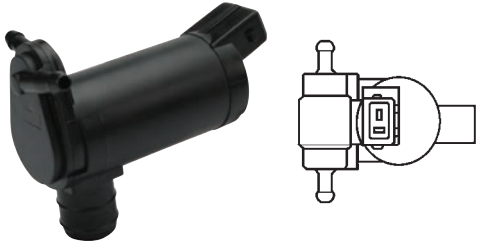

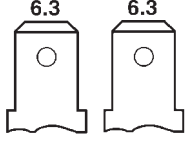

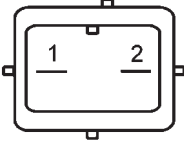
Can capacity: 3 l

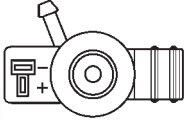
 Type: Can
 Motor: w/

	EL. SPECIFICATIONS	DIMENSIONS	ADDITIONAL SPECIFICATIONS
160967 Washer Tank <i>Doga ref. 232.2001.30.00.</i>			
	Voltage: 24	Can capacity: 2.1 l	Type: Can Can: w/ pump
PUMPS			
160197 Washer Pump Servicing: Porsche, Volvo, Volkswagen, Alfa Romeo, Audi, BMW, Fiat, Ford, Lancia, Mercedes-Benz, Opel, Porsche, Saab, Seat - Visit www.hc-cargo.com for further information			
	Voltage: 12	Capacity: 2400 ml/min	Type: Standard Pump type: Single
160198 Washer Pump Servicing: Scania, Mercedes-Benz - Visit www.hc-cargo.com for further information			
	Voltage: 24	Capacity: 2400 ml/min	Type: Universal Pump type: Single
160223 Washer Pump Servicing: Peugeot 104, 504 - Visit www.hc-cargo.com for further information <i>For independent mounting in engine compartment.</i>			
	Voltage: 12	Capacity: 1500 ml/min	Type: Universal Pump type: Single
160289 Washer Pump Servicing: Peugeot, Citroen, Renault - Visit www.hc-cargo.com for further information			
	Voltage: 24	Capacity: 1500 ml/min	Pump type: Single
160332 Washer Pump Servicing: Peugeot, Citroen, Renault - Visit www.hc-cargo.com for further information			
	Voltage: 12	Capacity: 1500 ml/min	Pump type: Single

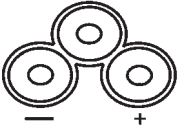
	EL. SPECIFICATIONS	DIMENSIONS	ADDITIONAL SPECIFICATIONS
160360 Washer Pump  	Servicing: Rover Group, Honda - Visit www.hc-cargo.com for further information Voltage: 12	Capacity: 1400 ml/min	Type: Universal Pump type: Single
160361 Washer Pump <i>Replacing original pump 115930290 on Skoda Favorit.</i>  	Servicing: Skoda Favorit - Visit www.hc-cargo.com for further information Voltage: 12	Capacity: 1200 ml/min	Type: Standard Pump type: Single
160378 Washer Pump  	Servicing: Ford, Opel, Seat, VW - Visit www.hc-cargo.com for further information Voltage: 12	Capacity: 2200 ml/min	Pump type: Single
160379 Washer Pump  	Servicing: Mercedes-Benz - Visit www.hc-cargo.com for further information Voltage: 12	Capacity: 2200 ml/min	Type: Standard Pump type: Single
160380 Washer Pump  	Servicing: VW, Opel, Seat, Ford - Visit www.hc-cargo.com for further information Voltage: 12	Capacity: 2400 ml/min	Type: Universal Pump type: Dual
160381 Washer Pump  	Servicing: Fiat, Vauxhall, Audi, Ford, Opel, VW, Wartburg - Visit www.hc-cargo.com for further information Voltage: 12	Capacity: 2000 ml/min	Type: Universal Pump type: Dual
160382 Washer Pump  	Servicing: Opel, Seat, VW - Visit www.hc-cargo.com for further information Voltage: 12	Capacity: 2400 ml/min	Type: Universal Pump type: Dual

		EL. SPECIFICATIONS	DIMENSIONS	ADDITIONAL SPECIFICATIONS
160383 Washer Pump 		Servicing: VW, Smart, Seat, Audi, BMW - Visit www.hc-cargo.com for further information Voltage: 12 Capacity: 2200 ml/min Type: Universal Pump type: Dual		
160385 Washer Pump 		Servicing: GM, Pontiac Firebird, Oldsmobile Ciera Delta - Visit www.hc-cargo.com for further information Voltage: 12 Capacity: 2600 ml/min Type: Standard Pump type: Single		
160386 Washer Pump 		Servicing: Honda Accord, Peugeot (UK), Ford - Visit www.hc-cargo.com for further information Voltage: 12 Capacity: 1800 ml/min Type: Universal Pump type: Single		
160507 Washer Pump  		Voltage: 24 Capacity: 1500 ml/min Type: Universal Pump type: Single		
160535 Washer Pump 		Servicing: Daihatsu, Ford, Mazda - Visit www.hc-cargo.com for further information Voltage: 12 Capacity: 1800 ml/min Type: Standard Pump type: Dual		
160583 Washer Pump <i>For rear windscreen.</i>  		Servicing: Daihatsu, Mazda, Mitsubishi - Visit www.hc-cargo.com for further information Voltage: 12 Capacity: 1350 ml/min Type: Standard Pump type: Single		

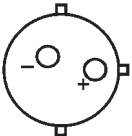
	EL. SPECIFICATIONS	DIMENSIONS	ADDITIONAL SPECIFICATIONS
160629 Washer Pump  	Servicing: Citroen, Fiat, Peugeot - Visit www.hc-cargo.com for further information Voltage: 12	Capacity: 1700 ml/min	Type: Standard Pump type: Dual
160630 Washer Pump HC-CARGO 160273.  	Voltage: 24	Capacity: 1800 ml/min	Type: Universal Pump type: Single
160677 Washer Pump  	Servicing: Daewoo, Hyundai, Kia, Mazda, Mitsubishi, Toyota - Visit www.hc-cargo.com for further information Voltage: 12	Capacity: 2000 ml/min	Type: Standard Pump type: Single
160679 Washer Pump  	Servicing: Mercedes-Benz - Visit www.hc-cargo.com for further information Voltage: 12	Capacity: 2100 ml/min	Type: Standard Pump type: Single
160680 Washer Pump  	Servicing: BMW - Visit www.hc-cargo.com for further information Voltage: 12	Capacity: 2300 ml/min	Type: Standard Pump type: Single
160681 Washer Pump  	Servicing: Audi - Visit www.hc-cargo.com for further information Voltage: 12	Capacity: 2400 ml/min	Type: Standard Pump type: Single

		EL. SPECIFICATIONS	DIMENSIONS	ADDITIONAL SPECIFICATIONS
160682 Washer Pump		Servicing: Audi - Visit www.hc-cargo.com for further information		
		Voltage: 12	Capacity: 2400 ml/min	Type: Standard Pump type: Dual
160683 Washer Pump		Servicing: Audi, BMW, Mercedes-Benz, Seat, Skoda, VW - Visit www.hc-cargo.com for further information		
		Voltage: 12	Capacity: 2200 ml/min	Type: Standard Pump type: Dual
160684 Washer Pump		Servicing: Citroen Berlingo, Saxo, Xantia, Fiat Ulysse, Peugeot, Pegaso - Visit www.hc-cargo.com for further information		
		Voltage: 12	Capacity: 2200 ml/min	Type: Standard Pump type: Single
JETS				
160190 Washer Jet				
			OD: 18 mm Length: 16 mm	Jet: Dual
160192 Washer Jet				
				Jet: Dual
160685 Washer Jet				
			OD: 25 mm Length: 52 mm	Jet: Dual
160686 Washer Jet				
			OD: 15 mm Length: 9 mm	Jet: Single

160688 Washer Jet
Universal.

 OD: 16 mm
 Length: 10 mm

Jet: Dual

160917 Washer Jet

 Servicing: Installation of wiper arms - Visit www.hc-cargo.com for further information

Jet: Dual

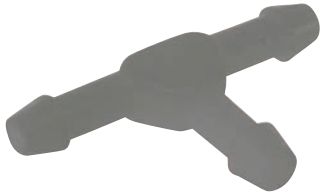
CONNECTIONS
160195 T-Connection

 Dim.: 36.5x21 mm
 OD: 4 mm

Valve: w/o

160413 Pipe Connector
For hose I.D. 4 mm.

 Length: 8 mm
 OD: 32 mm

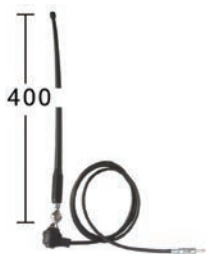
Valve: w/

RADIO ACCESSORIES
AERIALS
040077 Aerial
Removable mast.

Ohm: 150

 Length: 400 mm
 Cable length: 1200 mm
 Hole size: 8 mm
 Mount. angle: 0-180°

 Colour: Black
 Material: Rubber

040094 Aerial Extension Lead

Cable length: 3500 mm

040177 Aerial			
<i>Extended. w/ spring.</i>			
	Ohm: 150	Length: 950 mm Cable length: 2100 mm Hole size: 8 mm Mount. angle: 0-90°	Type: 2 sections Colour: Black Material: Stainless steel
040178 Aerial			
<i>Extended. Black base, w/ dummy spring.</i>			
	Ohm: 150	Length: 920 mm Cable length: 1200 mm Hole size: 8 mm Mount. angle: 0-180°	Type: 2 sections Colour: Black Material: Stainless steel
040181 Aerial			
<i>Removable mast.</i>			
	Ohm: 150	Length: 880 mm Cable length: 1600 mm Hole size: 18 mm Mount. angle: 0-45°	Colour: Black Material: Fiber glass
040182 Aerial			
<i>Removable mast.</i>			
	Ohm: 75	Length: 880 mm Cable length: 1600 mm Hole size: 18 mm Mount. angle: 0-45°	Colour: Black Material: Fiber glass
040190 Aerial			
<i>Removable mast.</i>			
	Ohm: 150	Length: 570 mm Cable length: 1300 mm Hole size: 18 mm Mount. angle: 0-45°	Colour: Black Material: Fiber glass
040191 Aerial			
<i>Extended.</i>			
	Ohm: 150	Length: 1300 mm Length 2: 400 mm Cable length: 1500 mm Hole size: 12 mm	Mount.: Pillar Type: 3 sections Colour: Black Material: Stainless steel

040215 Aerial

Extended.



Ohm: 150

Length: 1000 mm
Cable length: 1500 mm
Hole size: 12 mm

Mount.: Pillar
Type: 3 sections
Colour: Black
Material: Stainless steel

EXTENSION LEADS

040018 Aerial Extension Lead



Cable length: 600 mm

040019 Aerial Extension Lead



Cable length: 1000 mm

040192 Aerial Extension Lead



Cable length: 2000 mm

PLUGS & SOCKETS

040096 Aerial Plug



Male/female: Male

040199 Aerial Plug

New standard (ISO).



040200 Aerial Adaptor

New to old male plug ISO>DIN.



040201 Aerial Adaptor

Old to new male plug DIN>ISO.



**CAPASITORS
FOR CAR RADIOS**

150100 Capacitor

For car radios.



El. capacitance:
2.2 μ F

Length: 100 mm

Type: Universal
Mount. bracket: Straight
Plug: Straight
Cable: w/

150101 Capacitor

For car radios.



El. capacitance:
2.2 μ F

Length: 80 mm

Type: Universal
Mount. bracket: Angled
Plug: Angled
Cable: w/

150407 Capacitor

For car radios.



El. capacitance:
2.2 μ F

Length: 40 mm

Type: Universal
Mount. bracket: Angled
Plug: Angled
Cable: w/

150408 Capacitor

For car radios.



El. capacitance:
2.2 μ F

Length: 100 mm

Type: Universal
Mount. bracket: Angled
Plug: Ring
Cable: w/

LOUDSPEAKER IN CABINET

040197 Speakers



Watt: 20/40
Ohm: 4

Length: 97 mm
Depth: 95 mm
Width: 95 mm

Cabinet: Yes
Mount. bracket: w/
Unit: Set

LOUDSPEAKER BUILT-IN

040193 Speakers

70-23000 Hz.



Watt: 150
Ohm: 4

ID/hole: 95 mm
Depth: 50 mm
Dist./mount. holes 1:
80 mm
Dist./mount. holes 2:
115 mm
Width: 100 mm

Type: Built-in
System: 2 way
Grill: w/
Unit: Set

040194 Speakers

60-23000 Hz.

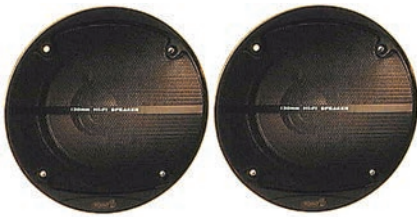

Watt: 25/50
Ohm: 4

ID/hole: 113 mm
Depth: 60 mm
Dist./mount. holes 1:
97 mm
Dist./mount. holes 2:
136 mm
Width: 131 mm

Type: Built-in
System: 2 way
Grill: w/
Unit: Set

RADIO MOUNTING KITS

040149 Radio Box



Colour: Black
Material: Acrylic
Mount. bracket: Pendant
Integral front: Yes

040170 Radio Mounting Kit

Galvanized. w/ gasket.



Integral front: Yes

DASHBOARD GAUGES

AMMETER

160697 Ammeter

White figures.



Voltage: 12-24

OD: 52 mm

Mount. type: Hook fastening
Colour: Black
Measuring range: 30-0-30
Measuring unit: A

160698 Ammeter

White figures.



Voltage: 12-24

OD: 52 mm

Mount. type: Hook fastening
Colour: Black
Measuring range: 60-0-60
Measuring unit: A

VOLTMETER

160695 Voltmeter

White figures.



Voltage: 8-16

OD: 52 mm

Mount. type: Hook fastening
Colour: Black
Measuring range: 8-16
Measuring unit: v

160696 Voltmeter

White figures.



Voltage: 16-32

OD: 52 mm

Mount. type: Hook fastening
Colour: Black
Measuring range: 16-32
Measuring unit: v

HOUR METER

160702 Hour Meter

w/o illumination.



Voltage: 12-28

OD: 52 mm

Type: Mechanical
Mount. type: Hook fastening
Colour: Black
Measuring unit: Timer

160747 Hour Meter

w/o illumination.



Voltage: 10-28

OD: 36.5x25 mm

Type: Electrical operated
Colour: Black
Measuring unit: Timer

160897 Hour Meter

Digital.



Voltage: 10-28

OD: 52 mm

Type: Electrical operated
Mount. type: Hook fastening
Colour: Black
Measuring unit: Timer
Digital: Yes

FUEL GAUGES

160701 Fuel Gauge

10-180 Ohm.

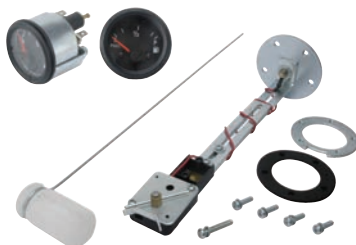

Voltage: 12

OD: 52 mm

Mount. type: Hook fastening
Colour: Black
Measuring unit: l
Sender: w/

160872 Fuel Gauge

Voltage: 24

OD: 52 mm

 Mount. type: Hook fastening
 Colour: Black
 Measuring unit: l
 Sender: w/

160873 Fuel Gauge

Servicing: HC-CARGO 160701, 160872

Voltage: 12/24

WATER TEMP. GAUGES
160699 Water Temp. Gauge

Transmitter 1/8" NPTF: HC-CARGO 160786.



Voltage: 12

OD: 52 mm

 Type: Electrical operated
 Mount. type: Hook fastening
 Colour: Black
 Measuring range: 40-120
 Measuring unit: C°
 Sender: w/

160778 Water Temp. Gauge

Transmitter 1/8" NPTF: HC-CARGO 160786.



Voltage: 24

OD: 52 mm

 Type: Electrical operated
 Mount. type: Hook fastening
 Colour: Black
 Measuring range: 40-120
 Measuring unit: v
 Sender: w/

OIL PRESSURE GAUGES
160700 Electrical Oil Pressure Gauge

Transmitter 1/8" NPTF: HC-CARGO 160787.



Voltage: 12

OD: 52 mm

 Type: Electrical operated
 Mount. type: Hook fastening
 Colour: Black
 Measuring range: 0-10
 Measuring unit: bar
 Sender: w/

160779 Oil Pressure Gauge

Transmitter 1/8" NPTF: HC-CARGO 160786.



Voltage: 24

OD: 52 mm

 Type: Electrical operated
 Mount. type: Hook fastening
 Colour: Black
 Measuring range: 0-10
 Measuring unit: bar
 Sender: w/

IGNITION COMPONENTS

COILS

150183 Electronic Ignition Coil			Servicing: Citroen, Peugeot - Visit www.hc-cargo.com for further information		
			Voltage: 12		
			Type: Electronic, Dry No./terminals: 4		
150187 Electronic Ignition Coil			Servicing: Opel, Vauxhall - Visit www.hc-cargo.com for further information		
			Voltage: 12		
			Type: Electronic, Dry No./terminals: 2 No./terminals 2: 2		
150196 Electronic Ignition Coil			Servicing: Opel, Vauxhall - Visit www.hc-cargo.com for further information		
			Voltage: 12		
			Type: Electronic, Dry No./terminals: 2 No./terminals 2: 2		
150246 Electronic Ignition Coil			Servicing: Alfa Romeo, Fiat, Lancia - Visit www.hc-cargo.com for further information		
<i>2 units on each vehicle.</i>					
			Voltage: 12		
			Type: Electronic, Dry No./terminals: 2		
150247 Electronic Ignition Coil			Servicing: Citroen, Peugeot - Visit www.hc-cargo.com for further information		
			Voltage: 12		
			Type: Electronic, Dry No./terminals: 4		
150252 Electronic Ignition Coil			Servicing: Alfa Romeo, Citroen, Fiat, Honda, Kia, Lancia, Land Rover, Peugeot - Visit www.hc-cargo.com for further information		
<i>2 units on each vehicle.</i>					
			Voltage: 12		
			Type: Electronic, Dry No./terminals: 3		



	EL. SPECIFICATIONS	DIMENSIONS	ADDITIONAL SPECIFICATIONS
150259 Electronic Ignition Coil 	Servicing: Citroen, Fiat, Innocenti, Lancia, Peugeot - Visit www.hc-cargo.com for further information Voltage: 12		Type: Electronic, Dry No./terminals: 4
150266 Electronic Ignition Coil 	Servicing: Toyota - Visit www.hc-cargo.com for further information Voltage: 12		Type: Electronic, Dry No./terminals: 2
150267 Electronic Ignition Coil 	Servicing: Toyota - Visit www.hc-cargo.com for further information Voltage: 12		Type: Electronic, Dry No./terminals: 2
150270 Electronic Ignition Coil 	Servicing: Honda, Rover - Visit www.hc-cargo.com for further information Voltage: 12		Type: Electronic, Dry No./terminals: 2
150272 Electronic Ignition Coil 	Servicing: Honda - Visit www.hc-cargo.com for further information Voltage: 12		Type: Electronic, Dry No./terminals: 2
150273 Electronic Ignition Coil 	Servicing: Ford, Infiniti, Nissan - Visit www.hc-cargo.com for further information Voltage: 12		Type: Electronic, Dry No./terminals: 2
150275 Electronic Ignition Coil 	Servicing: Mazda, Suzuki - Visit www.hc-cargo.com for further information Voltage: 12		Type: Electronic, Dry No./terminals: 2





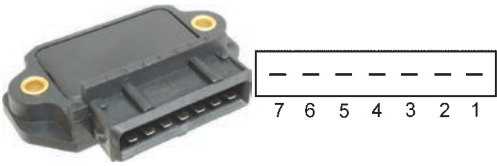

EL. SPECIFICATIONS	DIMENSIONS	ADDITIONAL SPECIFICATIONS
<p>150278 Electronic Ignition Coil</p> 	<p>Servicing: Opel, Vauxhall - Visit www.hc-cargo.com for further information</p> <p>Voltage: 12</p>	<p>Type: Electronic, Dry</p> <p>No./terminals: 4</p>
<p>150415 Electronic Ignition Coil</p> 	<p>Servicing: Renault - Visit www.hc-cargo.com for further information</p> <p>Voltage: 12</p>	<p>Type: Electronic, Dry</p>
<p>150416 Electronic Ignition Coil</p> 	<p>Servicing: Mazda, Ford - Visit www.hc-cargo.com for further information</p> <p>Voltage: 12</p>	<p>Type: Electronic, Dry</p> <p>No./terminals: 3</p>
<p>150424 Electronic Ignition Coil</p> 	<p>Servicing: Daewoo, Mercedes-Benz, Puch (Steyr-Daimler), Ssangyong, VW - Visit www.hc-cargo.com for further information</p> <p>Voltage: 12</p>	<p>Type: Electronic Dry</p>
<p>150428 Electronic Ignition Coil</p> 	<p>Servicing: Audi, Seat, Skoda, VW - Visit www.hc-cargo.com for further information</p> <p>Voltage: 12</p>	<p>Type: Electronic, Dry</p>
<p>150429 Electronic Ignition Coil</p> 	<p>Servicing: Renault, Volvo - Visit www.hc-cargo.com for further information</p> <p>Voltage: 12</p>	<p>Type: Electronic, Dry</p>
<p>150430 Electronic Ignition Coil</p> 	<p>Servicing: Renault, Volvo - Visit www.hc-cargo.com for further information</p> <p>Voltage: 12</p>	<p>Type: Electronic, Dry</p>

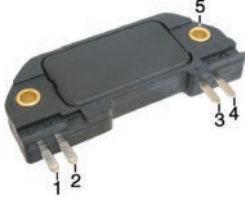
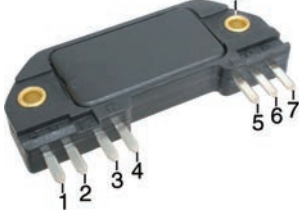
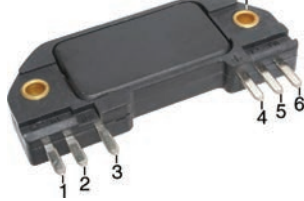
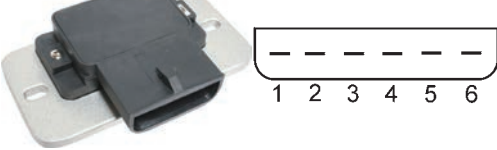
	EL. SPECIFICATIONS	DIMENSIONS	ADDITIONAL SPECIFICATIONS
150433 Electronic Ignition Coil 	Servicing: Nissan, Renault - Visit www.hc-cargo.com for further information Voltage: 12		Type: Electronic, Dry
150434 Electronic Ignition Coil 	Servicing: Renault - Visit www.hc-cargo.com for further information Voltage: 12		Type: Electronic, Dry
150441 Electronic Ignition Coil 	Servicing: Nissan, Renault - Visit www.hc-cargo.com for further information Voltage: 12		Type: Electronic, Dry
150505 Electronic Ignition Coil 	Servicing: Nissan, Opel, Renault, Vauxhall - Visit www.hc-cargo.com for further information Voltage: 12		Type: Electronic, Dry, Pencil
150506 Electronic Ignition Coil 	Servicing: Vauxhall, Citroen, Fiat, Lancia, Peugeot, Renault - Visit www.hc-cargo.com for further information Voltage: 12		Type: Electronic, Dry, Pencil
150508 Electronic Ignition Coil 	Servicing: Audi, Seat, Skoda, VW - Visit www.hc-cargo.com for further information Voltage: 12		Type: Electronic, Dry, Pencil
150509 Electronic Ignition Coil 	Servicing: Audi, Seat, Skoda, VW - Visit www.hc-cargo.com for further information Voltage: 12		Type: Electronic, Dry, Pencil

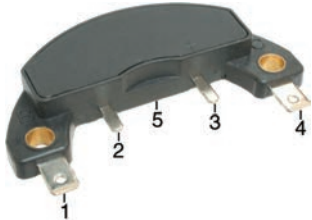

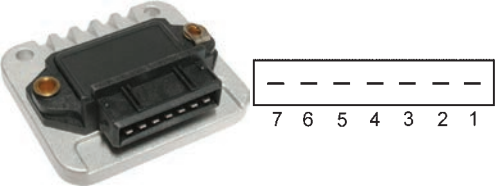
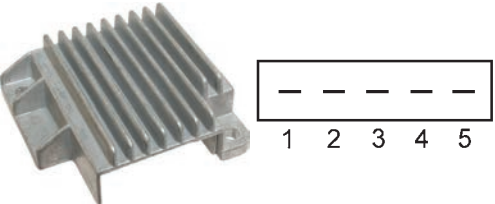





EL. SPECIFICATIONS	DIMENSIONS	ADDITIONAL SPECIFICATIONS
<p>150513 Electronic Ignition Coil</p> 	<p>Servicing: Skoda, VW - Visit www.hc-cargo.com for further information</p> <p>Voltage: 12</p>	<p>Type: Electronic, Dry, Pencil No./terminals: 4</p>
<p>150514 Electronic Ignition Coil</p> 	<p>Servicing: Volvo - Visit www.hc-cargo.com for further information</p> <p>Voltage: 12</p>	<p>Type: Electronic, Dry, Pencil</p>
<p>150518 Electronic Ignition Coil</p> 	<p>Servicing: Audi, Seat, Skoda, VW - Visit www.hc-cargo.com for further information</p> <p>Voltage: 12</p>	<p>Type: Electronic, Dry No./terminals: 4</p>
<p>150519 Electronic Ignition Coil</p> 	<p>Servicing: Mercedes-Benz, Opel, Vauxhall - Visit www.hc-cargo.com for further information</p> <p>Voltage: 12</p>	<p>Type: Electronic, Dry No./terminals: 3</p>
<p>150520 Electronic Ignition Coil</p> 	<p>Servicing: Citroen, Peugeot - Visit www.hc-cargo.com for further information</p> <p>Voltage: 12</p>	<p>Type: Electronic, Dry</p>
<p>150521 Electronic Ignition Coil</p> 	<p>Servicing: Opel, Vauxhall - Visit www.hc-cargo.com for further information</p> <p>Voltage: 12</p>	<p>Type: Electronic, Dry</p>
<p>150522 Electronic Ignition Coil</p> 	<p>Servicing: Citroen, Peugeot - Visit www.hc-cargo.com for further information</p> <p>Voltage: 12</p>	<p>Type: Electronic, Dry</p>

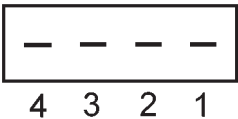

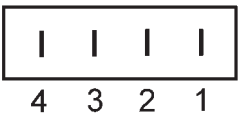
	EL. SPECIFICATIONS	DIMENSIONS	ADDITIONAL SPECIFICATIONS
150523 Electronic Ignition Coil 	Servicing: Citroen, Mazda - Visit www.hc-cargo.com for further information Voltage: 12		Type: Electronic, Dry
150524 Electronic Ignition Coil 	Servicing: Opel - Visit www.hc-cargo.com for further information Voltage: 12		Type: Electronic, Dry
150525 Electronic Ignition Coil 	Servicing: Opel - Visit www.hc-cargo.com for further information Voltage: 12		Type: Electronic, Dry
UNIVERSAL			
150037 Electronic Ignition Coil 	Voltage: 12	OD: 55 mm	Type: Universal, Oil cooled, Ordinary No./terminals: 2
150169 Electronic Ignition Coil 	Voltage: 12	OD: 60 mm	Type: Universal, Oil cooled, Super No./terminals: 2
150395 Electronic Ignition Coil <i>w/ external resistor.</i> 	Servicing: Hitachi - Visit www.hc-cargo.com for further information Voltage: 12		Type: Universal, High Power, Dry No./terminals: 2 Terminals w/thread: Yes
MODULES			
150055 Ignition Module <i>Also repl. ignition modules w/ 6 terminals.</i> 			Servicing: Alfa Romeo, BMW, Citroen, Fiat, Mercedes-Benz, Opel, Peugeot, Talbot, Vauxhall, Zastava - Visit www.hc-cargo.com for further information Type: Pick up Terminals: 7 1: KI1 2: KI31/Ground 3: KI31/Ground 4: KI15 5: G+ 6: G- 7: TACH/rpm

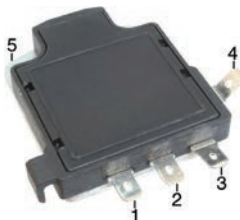
EL. SPECIFICATIONS	DIMENSIONS	ADDITIONAL SPECIFICATIONS
150056 Ignition Module Servicing: Alfa, BMW, GM, KHD, Renault, Audi, Opel, Porsche, Saab, Seat, Vauxhall, Volvo, VW - Visit www.hc-cargo.com for further information		
<i>Also repl. ignition modules w/ 6 terminals.</i>		
		Type: Hall Terminals: 7 1: K11 2: K131/Ground 3: K131/Ground 4: K115 5: G+ 6: G° 7: TACH/rpm
150057 Ignition Module Servicing: Alfa Romeo, Citroen, Ford, Peugeot - Visit www.hc-cargo.com for further information		
		Type: Pick up Terminals: 5 1: K11 2: K131/Ground 3: K115 4: G+ 5: G-
150058 Ignition Module Servicing: AMC, GM, Opel, Peugeot, Vauxhall, Alfa Romeo, Autobianchi, Fiat, Lancia, Polski-Fiat, Renault - Visit www.hc-cargo.com for further information		
		Type: Pick up Terminals: 5 1: G-/W 2: G+/G 3: K115/B 4: K11/C 5: K131/Ground
150062 Ignition Module Servicing: AMC, Buick, Cadillac, Chevrolet, GM, Jeep, Oldsmobile, Pontiac, Opel, Vauxhall - Visit www.hc-cargo.com for further information		
		Type: Pick up Terminals: 5 1: G- 2: G+ 3: K115 4: K11 5: K131/Ground
150063 Ignition Module Servicing: GM, Honda, Opel, Vauxhall - Visit www.hc-cargo.com for further information		
		Type: Pick up Terminals: 8 1: G+/P 2: G-/N 3: Input/E 4: Output/R 5: K115/+ 6: K11/C 7: Output/B 8: K131/Ground
150064 Ignition Module Servicing: Opel, Vauxhall - Visit www.hc-cargo.com for further information		
		Type: Pick up Terminals: 7 1: G+/P 2: G-/N 3: Input/T 4: K115/+ 5: K11/C 6: Output/0 7: K131/Ground
150067 Ignition Module Servicing: Ford, Renault V.I. - Visit www.hc-cargo.com for further information		
		Type: Pick up Terminals: 6 1: K11 2: K115 3: NC 4: G+ 5: G- 6: K131/Ground

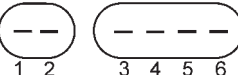

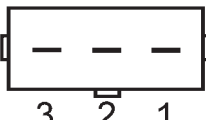
	EL. SPECIFICATIONS	DIMENSIONS	ADDITIONAL SPECIFICATIONS
150068 Ignition Module 	Servicing: Chrysler, Mazda, Mitsubishi - Visit www.hc-cargo.com for further information		Type: Pick up Terminals: 5 1: KI15/B 2: G- 3: G+ 4: KI1/C 5: KI31/Ground
150072 Ignition Module 	Servicing: Ford - Visit www.hc-cargo.com for further information		Type: Pick up Terminals: 5 1: G+ 2: G- 3: KI15 4: KI31/Ground 5: KI1
150075 Ignition Module 	Servicing: Audi, Saab, Seat, Volvo, VW, Wartburg - Visit www.hc-cargo.com for further information		Type: Hall Terminals: 7 1: KI1 2: KI31/Ground 3: KI31/Ground 4: KI15 5: G+ 6: G° 7: TACH/rpm
150088 Ignition Module 	Servicing: Fiat, Innocenti, Lancia - Visit www.hc-cargo.com for further information		Type: Pick up Terminals: 5 1: G- 2: G+ 3: KI15 4: KI1 5: KI31/Ground
150091 Ignition Module 	Servicing: GM, Isuzu, Honda, Nissan, Subaru - Visit www.hc-cargo.com for further information		Type: Pick up Terminals: 3 1: KI31/Ground 2: KI1 3: KI15
150092 Ignition Module 	Servicing: Toyota - Visit www.hc-cargo.com for further information		Type: Pick up Terminals: 6 1: TACH/rpm 2: KI1/C (Yellow) 3: KI15 (Red) 4: KI31/Ground 5: +/G+ 6: -/G-
150096 Ignition Module 	Servicing: Chrysler, Hyundai, Mazda, Mitsubishi - Visit www.hc-cargo.com for further information		Type: Pick up Terminals: 3 1: KI31/Ground 2: KI15/B 3: KI1/C

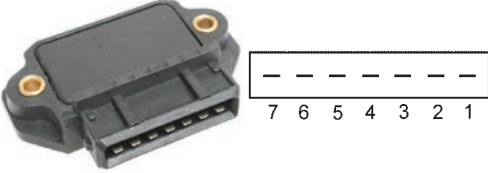
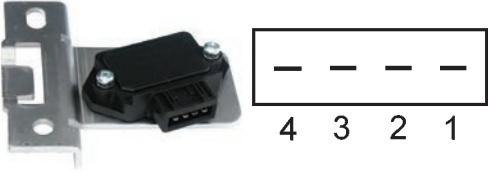
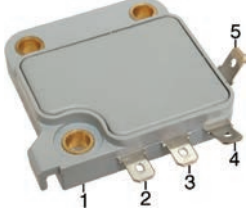
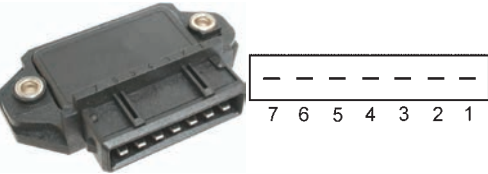
EL. SPECIFICATIONS	DIMENSIONS	ADDITIONAL SPECIFICATIONS
150098 Ignition Module Servicing: Volvo, 0001512001, Citroen, Opel, Peugeot, Porsche, Renault V.I., Saab, Seat, Vauxhall - Visit www.hc-cargo.com for further information		
		Type: Amplifier Terminals: 6 1: K11 2: K131/Ground 3: K131/Ground 4: K115 5: Input 6: NC 7: NC
150154 Ignition Module Servicing: Mercedes-Benz, Puch (Steyr-Daimler) - Visit www.hc-cargo.com for further information		
		Type: Pick up Type/terminal: Bullet Terminals: 6 1: G+ 2: G- 3: K11/16 4: K115 5: K131/Ground 6: TACH/rpm
150157 Ignition Module Servicing: Toyota - Visit www.hc-cargo.com for further information		
		Type: Pick up Terminals: 6 1: K115/B (Red) 2: K11/C (Yellow) 3: K131/Ground 4: TACH/rpm 5: + 6: -
150160 Ignition Module Servicing: Ford, Nissan, Suzuki, Mazda - Visit www.hc-cargo.com for further information		
		Type: Pick up Terminals: 5 1: K115/B 2: K11/C 3: G+ 4: G- 5: K131/Ground
150165 Ignition Module Servicing: Alfa Romeo, Ferrari, Fiat, Lancia - Visit www.hc-cargo.com for further information		
		Type: Amplifier Terminals: 7 1: K11 2: K131/Ground 3: K131/Ground 4: K115 5: NC 6: Input 7: NC
150168 Ignition Module Servicing: Ford - Visit www.hc-cargo.com for further information		
		Type: Amplifier Terminals: 7 1: K131/Ground 2: K1/C 3: K115 4: HB+ 5: SP 6: PIP 7: K131/Ground
150171 Ignition Module Servicing: Audi, Seat, Skoda, VW - Visit www.hc-cargo.com for further information		
		Type: Amplifier Terminals: 5 1: K131/Ground 2: Input 3: K115 4: K11 5: K115

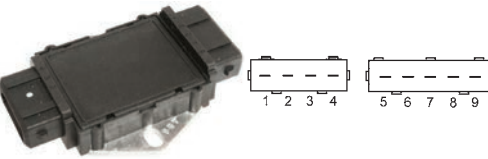
EL. SPECIFICATIONS		DIMENSIONS	ADDITIONAL SPECIFICATIONS
150175 Ignition Module  		Servicing: Opel, Vauxhall - Visit www.hc-cargo.com for further information	Type: Amplifier Terminals: 4 1: KI1 2: KI31/Ground 3: KI15 4: Input
150215 Ignition Module  		Servicing: Skoda - Visit www.hc-cargo.com for further information	Type: Pick up Terminals: 5 1: KI15 2: G- 3: G+ 4: KI1 5: KI31/Ground
150234 Ignition Module 		Servicing: Mazda - Visit www.hc-cargo.com for further information	Type: Pick up Type/terminal: Internal thread Terminals: 5 1: KI1/C 2: KI15/B 3: KI31/Ground 4: G+/+ 5: G-/SG
150235 Ignition Module 		Servicing: Mazda - Visit www.hc-cargo.com for further information	Type: Pick up Terminals: 6 1: G+ 2: KI31/Ground 3: W- 4: KI15 5: KI1/C 6: A/Advance
150236 Ignition Module 		Servicing: Acura, Honda - Visit www.hc-cargo.com for further information	Type: Amplifier Terminals: 5 1: Input 2: KI15 3: KI1 4: TACH/rpm 5: KI31/Ground
150239 Ignition Module  		Servicing: GM USA, Daewoo - Visit www.hc-cargo.com for further information	Type: Amplifier Terminals: 8 1: KI15 2: KI1/C 3: KI31/Ground 4: B(ECU) 5: B(ECU) 6: E(ECU) 7: G+ 8: W-
150377 Ignition Module  		Servicing: Suzuki, Audi, Hyundai, Mitsubishi, Seat, Skoda, VW - Visit www.hc-cargo.com for further information	Type: Amplifier Terminals: 3 1: Input 2: KI31/Ground 3: KI1

EL. SPECIFICATIONS	DIMENSIONS	ADDITIONAL SPECIFICATIONS
150378 Ignition Module 	Servicing: Mitsubishi - Visit www.hc-cargo.com for further information	Type: Amplifier Terminals: 5 1: K11/C 2: K115/B 3: K131/Ground 4: G+/+ 5: G-/SG
150379 Ignition Module 	Servicing: BMW, Opel, Alfa Romeo, Citroen, Lancia, Peugeot, Porsche - Visit www.hc-cargo.com for further information	Type: Amplifier Terminals: 7 1: K11 2: Input 3: NC 4: K131/Ground 5: NC 6: K11 7: Input
150380 Ignition Module <i>w/ bracket.</i> 	Servicing: Opel, Vauxhall - Visit www.hc-cargo.com for further information	Type: Amplifier Terminals: 4 1: K11 2: K131/Ground 3: K115 4: Input
150384 Ignition Module 	Servicing: Honda - Visit www.hc-cargo.com for further information	Type: Amplifier Terminals: 5 1: K131/Ground 2: Input 3: K115 4: K11 5: RPM out/TD
150387 Ignition Module 	Servicing: Alfa Romeo, Ferrari, Opel, Volvo - Visit www.hc-cargo.com for further information	Type: Amplifier Terminals: 7 1: K11 2: Input 3: K11 4: K131/Ground 5: Input 6: K11 7: Input
150398 Ignition Module 	Servicing: Hitachi, Honda - Visit www.hc-cargo.com for further information	Type: Pick up Terminals: 5 1: Ground 2: C+/B 3: B+/B2 4: TACH/rpm 5: C-/C
150406 Ignition Module 	Servicing: Skoda, Audi, Seat, VW - Visit www.hc-cargo.com for further information	Type: Amplifier Terminals: 9 1: K11.4 2: L11.3 3: K11.2 4: K11.1 5: Input4 6: Input3 7: K131 8: Input2 9: Input1

	EL. SPECIFICATIONS	DIMENSIONS	ADDITIONAL SPECIFICATIONS
150409 Ignition Module 	Servicing: VW, Passat, Audi - Visit www.hc-cargo.com for further information		Type: Amplifier Terminals: 7 1: KI1.1 2: KI1.2 3: KI1.3 4: Input1 5: Input2 6: KI31 7: Input3
150417 Ignition Module 	Servicing: Mazda - Visit www.hc-cargo.com for further information		Type: Pick up Terminals: 6 1: KI1/G 2: KI15/B 3: G+ 4: KI31/Ground 5: W- 6: A
150512 Ignition Module <i>Hall.</i> 	Servicing: Mitsubishi - Visit www.hc-cargo.com for further information		Type: Hall Terminals: 6
ELECTRONIC KITS			
150227 Electronic Ignition Kit <i>Does not fit VW w/ Telefunken plant.</i> 	Voltage: 12		Type: Dry Terminals/ignition coil: 2 Terminals/module: 3 Terminals w/thread: Yes
150228 Electronic Ignition Kit 	Voltage: 12		Type: Dry Terminals/ignition coil: 2 Terminals/module: 3 Terminals w/thread: Yes
150231 Electronic Ignition Kit 	Voltage: 12		Type: Dry Terminals/ignition coil: 2 Terminals/module: 6 Terminals w/thread: Yes
150403 Electronic Ignition Kit 	Voltage: 12		Type: Dry Terminals/module: 4

	EL. SPECIFICATIONS	DIMENSIONS	ADDITIONAL SPECIFICATIONS
150435 Electronic Ignition Kit 	Servicing: Audi, Seat, Skoda, VW - Visit www.hc-cargo.com for further information Voltage: 12		Type: Dry Terminals/module: 4 Terminals w/thread: Yes
150516 Electronic Ignition Kit 	Servicing: Ford, Mercedes-Benz, VW - Visit www.hc-cargo.com for further information Voltage: 12		Type: Dry Terminals/module: 5

SPARK PLUG CAPS

150004 Spark Plug Cap

For spark plug w/ nut.



		Mount. angle: 90	Nut: w/ Resistor: w/
---	--	------------------	-------------------------

SWITCHES & SENSORS - ENGINE MANAGEMENT

SENSORS

LAMBDA SENSORS

UNIVERSAL

181584 Universal Lambda Sensor 	Servicing: Audi, BMW, Daewoo, Daihatsu, DeLorean, Fiat, Honda, Hyundai, Jaguar, Kia, Lancia, Lotus, Mazda, Mercedes-Benz - Visit www.hc-cargo.com for further information	Sensor dia.: 21 mm Thread type: M18-1.5	Connection: Signal + Type: Universal, Zirconia Colour: Black No./wires: 1 Plug: w/o
181585 Universal Lambda Sensor 	Servicing: Alfa Romeo, Audi, Autobianchi, BMW, Chevrolet, Daimler, Ferrari, Fiat, Ford, Hyundai, Isuzu, Jaguar, Kia, Lancia, Mazda - Visit www.hc-cargo.com for further information	Sensor dia.: 21.8 mm Thread type: M18-1.5 Watt: 12	Connection: Pre heating +, Pre heating -, Signal + Type: Universal, Zirconia Colour: Black - White - White No./wires: 3 Plug: w/o
181586 Universal Lambda Sensor 	Servicing: BMW, Citroen, Fiat, Jeep, Mazda, Mercedes-Benz, Peugeot, Renault, Seat, Skoda, Volvo, VW - Visit www.hc-cargo.com for further information	Sensor dia.: 21.8 mm Thread type: M18-1.5 Watt: 18	Connection: Pre heating +, Pre heating -, Signal +, Signal - Type: Universal, Zirconia Colour: Black - White - White - Grey No./wires: 4 Plug: w/o

EL. SPECIFICATIONS
DIMENSIONS
ADDITIONAL SPECIFICATIONS
181587 Universal Lambda Sensor

Servicing: Audi, Chrysler, Dodge, Fiat, Jeep, Mercedes-Benz, Nissan, Opel, Saab, Seat, Suzuki, Vauxhall, Volvo, VW - Visit www.hc-cargo.com for further information

18 W.



Sensor dia.: 21.8 mm
Thread type: M18-1.5
Watt: 18

Connection: Pre heating +, Pre heating -, Signal +
Type: Universal, Zirconia
Colour: Black - White - White
No./wires: 3
Plug: w/o

181588 Universal Lambda Sensor

Servicing: Alpina-BMW, Audi, Bentley, BMW, Citroen, Daewoo, Ferrari, Ford, Lada, Land Rover, Mazda, Mercedes-Benz, Opel, Peugeot - Visit www.hc-cargo.com for further information

18 W.



Sensor dia.: 21.8 mm
Thread type: M18-1.5
Watt: 18

Connection: Pre heating +, Pre heating -, Signal +, Signal -
Type: Universal, Zirconia
Colour: Black - White - White - Grey
No./wires: 4
Plug: w/o

181589 Universal Lambda Sensor

Servicing: Alfa Romeo, Austin, BMW, Chrysler, Citroen, Ferrari, Fiat, Ford, Honda, Lancia, Land Rover, Mazda, Mercedes-Benz, MG - Visit www.hc-cargo.com for further information

12 W.



Sensor dia.: 21.8 mm
Thread type: M18-1.5
Watt: 12

Connection: Pre heating +, Pre heating -, Signal +, Signal -
Type: Universal, Zirconia
Colour: Black - White - White - Grey
No./wires: 4
Plug: w/o

181590 Universal Lambda Sensor

Servicing: Aston Martin, Audi, BMW, Chevrolet, Chrysler, Citroen, Dacia, Daihatsu, Dodge, Ferrari, Fiat, Ford, Honda, Hyundai - Visit www.hc-cargo.com for further information

12 W.



Sensor dia.: 21.8 mm
Thread type: M18-1.5
Watt: 12

Connection: Pre heating +, Pre heating -, Signal +, Signal -
Type: Universal, Zirconia
Colour: Black - White - White - Grey
No./wires: 4
Plug: w/o

181591 Universal Lambda Sensor

Servicing: Alfa Romeo, Audi, Bentley, BMW, Cadillac, Chevrolet, Citroen, Daewoo, Daihatsu, Fiat, Ford, Honda, Hyundai, Jeep, Kia - Visit www.hc-cargo.com for further information

7 W.



Sensor dia.: 17.6 mm
Thread type: M18-1.5
Watt: 7

Connection: Pre heating +, Pre heating -, Signal +, Signal -
Type: Universal, Titania
Colour: Black - White - White - Grey
No./wires: 4
Plug: w/o

181592 Universal Lambda Sensor

Servicing: Alfa Romeo, Audi, Cadillac, Chrysler, Citroen, Dacia, Ferrari, Fiat, Ford, Honda, Lancia, Land Rover, Mercedes-Benz, MG - Visit www.hc-cargo.com for further information

7 W.



Sensor dia.: 17.6 mm
Thread type: M18-1.5
Watt: 7

Connection: Pre heating +, Pre heating -, Signal +, Signal -
Type: Universal, Titania
Colour: Black - White - White - Grey
No./wires: 4
Plug: w/o

AIR MASS METERS

181491 Air Mass Sensor

Servicing: Audi, Ford, Seat, Skoda, VW - Visit www.hc-cargo.com for further information



181493 Air Mass Sensor

Servicing: Audi, Ford, Seat, Skoda, VW - Visit www.hc-cargo.com for further information



181494 Air Mass Sensor

Servicing: GM, VW, Alfa Romeo, Fiat, Lancia, Opel, Vauxhall - Visit www.hc-cargo.com for further information



181495 Air Mass Sensor

Servicing: Toyota, GM, Alfa Romeo, Ferrari, Fiat, Honda, Lada, Lancia, Opel, Rover, Vauxhall, Volvo - Visit www.hc-cargo.com for further information



181496 Air Mass Sensor

Servicing: Audi, Seat, VW - Visit www.hc-cargo.com for further information



181497 Air Mass Sensor

Servicing: Audi, Seat, Skoda, VW - Visit www.hc-cargo.com for further information



181500 Air Mass Sensor

Servicing: Landrover, Daewoo, Ssang Yong, BMW, Mercedes-Benz - Visit www.hc-cargo.com for further information



MAP-SENSORS
180557 Map sensor

 Servicing: Isuzu, Vauxhall - Visit www.hc-cargo.com for further information

 Ref. area 1: 261 mV
 Ref. area 2: 4958 mV

 Pressure area 1: 15 kPa
 Pressure area 2: 102 kPa

180559 Map Sensor

 Servicing: Aston Martin, Ducati - Visit www.hc-cargo.com for further information

 Ref. area 1: 250 mV
 Ref. area 2: 4750 mV

 Pressure area 1: 17 kPa
 Pressure area 2: 105 kPa

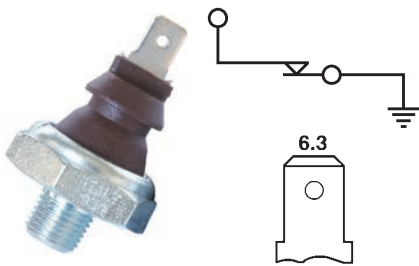
SWITCHES
OIL PRESSURE SWITCHES
180626 Oil Pressure Switch

 Thread type: M10-1 cone
 Pressure: 0.3 bar

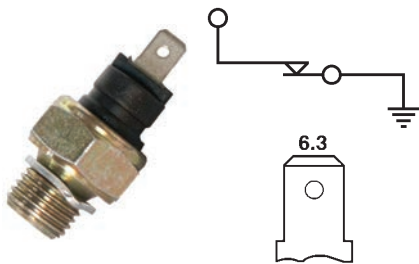
180630 7.0000 Oil Pressure Switch

 Servicing: Alfa Romeo, Bedford, Fiat, Iveco, Lada, Lancia, Opel, Polski-Fiat, Seat, Subaru, Vauxhall, VW, Zastava - Visit www.hc-cargo.com for further information

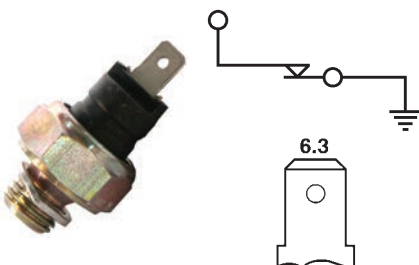
 Thread type: M14-1.5
 Pressure: 0.3 bar

180631 7.0001 Oil Pressure Switch

 Servicing: Fiat, Lancia, Seat - Visit www.hc-cargo.com for further information

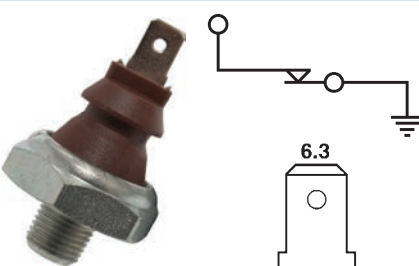
 Thread type: M12-1.5
 Pressure: 0.3 bar

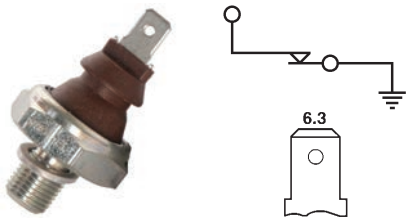
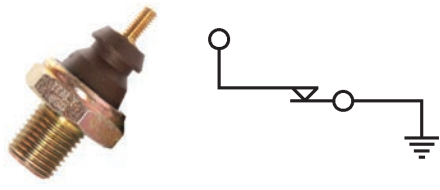
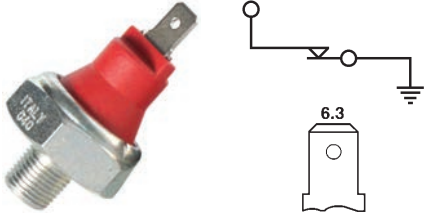
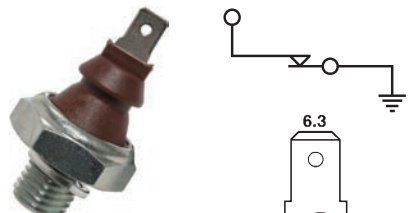
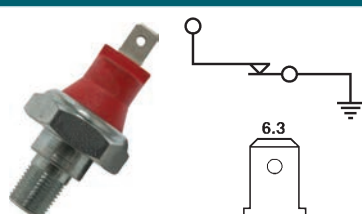
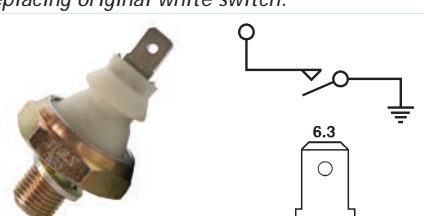
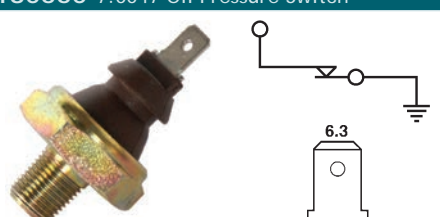
180634 7.0007 Oil Pressure Switch

 Servicing: Alfa Romeo, Audi, BMW, Rover - Visit www.hc-cargo.com for further information

 Thread type: M10-1 cone
 Pressure: 0.3 bar

EL. SPECIFICATIONS	DIMENSIONS	ADDITIONAL SPECIFICATIONS
180635 7.0008 Oil Pressure Switch Servicing: Alfa Romeo, Audi, Lancia, Seat, Volvo, VW - Visit www.hc-cargo.com for further information		
<i>Replacing original brown switch.</i>		
		Thread type: M10-1 Pressure: 0.3 bar
180636 7.0011 Oil Pressure Switch Servicing: Ford, Mazda - Visit www.hc-cargo.com for further information		
		Thread type: 1/4-18 NPT cone Pressure: 0.3 bar
180641 7.0017 Oil Pressure Switch Servicing: Acura, Chevrolet, Daewoo, Daihatsu, Ford, Hyundai, Kia, Mazda, Mitsubishi, Suzuki, Toyota, VW - Visit www.hc-cargo.com for further information		
		Thread type: 1/8 GAS cone Pressure: 0.4 bar
180648 7.0026 Oil Pressure Switch Servicing: BMW, Mercedes-Benz, Puch (Steyr-Daimler), Smart (MCC), VW - Visit www.hc-cargo.com for further information		
<i>Replacing original brown switch.</i>		
		Thread type: M12-1.5 Pressure: 0.35 bar
180649 7.0027 Oil Pressure Switch Servicing: Austin, Rover - Visit www.hc-cargo.com for further information		
		Thread type: 1/8-27 NPT cone Pressure: 0.5 bar
180658 7.0045 Oil Pressure Switch Servicing: Audi, Seat, VW - Visit www.hc-cargo.com for further information		
<i>Replacing original white switch.</i>		
		Thread type: M10-1 Pressure: 1.8 bar
180660 7.0047 Oil Pressure Switch Servicing: Volvo - Visit www.hc-cargo.com for further information		
		Thread type: 1/8-27 NPT cone Pressure: 0.5 bar

180688 7.0095 Oil Pressure Switch

 Servicing: Audi, Ford, Seat, Skoda, VW - Visit www.hc-cargo.com for further information

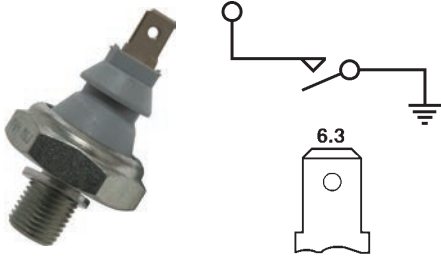
Replacing original brown and grey switch.

 Thread type: M10-1
 Pressure: 0.9 bar

180689 7.0096 Oil Pressure Switch

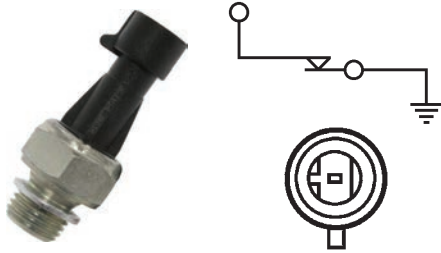
 Servicing: Alfa Romeo, Citroen, Fiat, Innocenti, Iveco, Lancia, Opel, Peugeot, Suzuki - Visit www.hc-cargo.com for further information

 Thread type: M14-1.5
 Pressure: 0.3 bar

180694 7.0108 Oil Pressure Switch

 Servicing: Audi, Ford, Mercedes-Benz, Renault, Seat, Skoda, Volvo, VW - Visit www.hc-cargo.com for further information

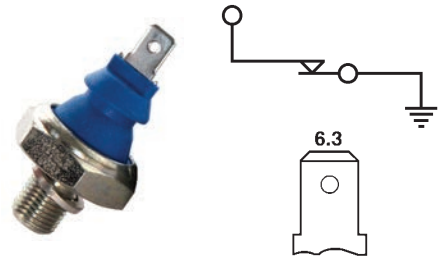
Replacing original light blue switch.

 Thread type: M10-1
 Pressure: 0.3 bar

181341 7.0141 Oil Pressure Switch

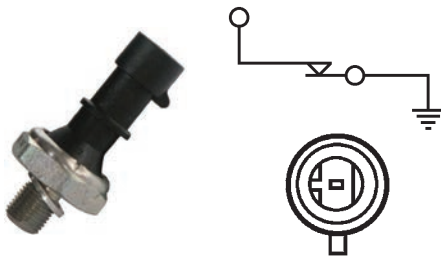
 Servicing: Opel, Vauxhall - Visit www.hc-cargo.com for further information

 Thread type: M10-1
 Pressure: 0.5 bar

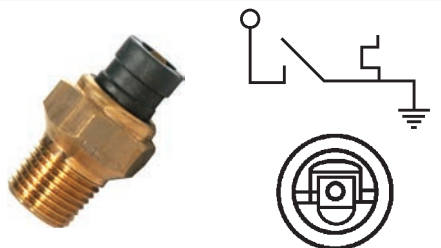
TEMPERATURE SWITCHES
180945 7.4000 Temperature Switch

 Servicing: Fiat, Lancia, Seat - Visit www.hc-cargo.com for further information

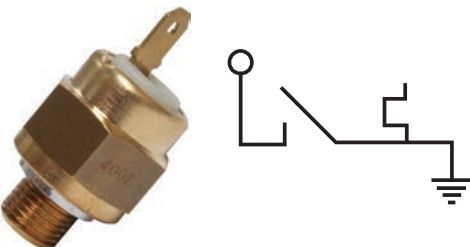
 Thread type: M16-1.5
 cone
 Working temp.: 115 °C

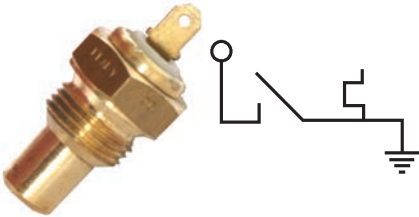
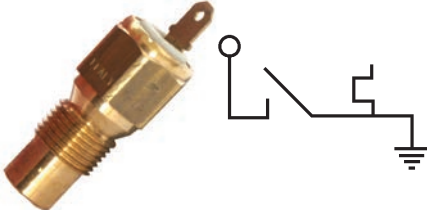
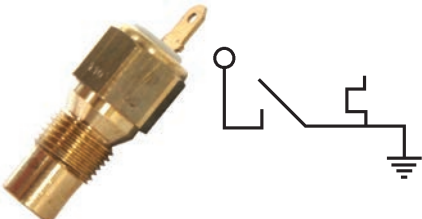
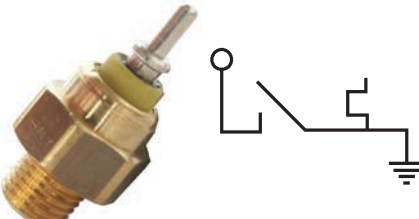
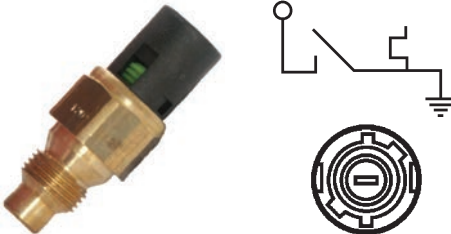
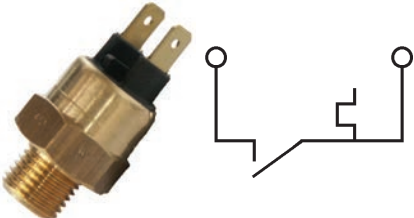
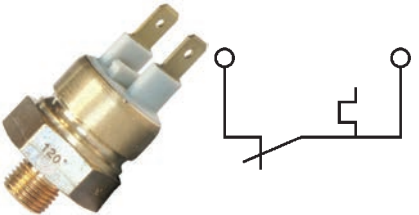
180949 7.4007 Temperature Switch

 Servicing: Audi - Visit www.hc-cargo.com for further information

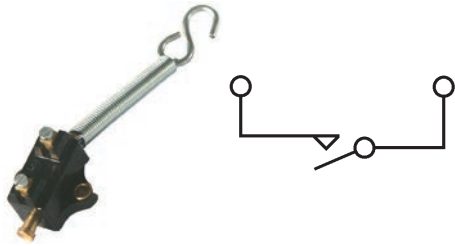
 Thread type: M10-1
 Working temp.: 120 °C

	EL. SPECIFICATIONS	DIMENSIONS	ADDITIONAL SPECIFICATIONS
180950 7.4014 Temperature Switch 	Servicing: Citroen, Fiat, Ford, Peugeot - Visit www.hc-cargo.com for further information	Thread type: M18-1.5 Working temp.: 105 °C	
180953 7.4029 Temperature Switch 	Servicing: Citroen, Ford, Peugeot - Visit www.hc-cargo.com for further information	Thread type: M14-1.25 Working temp.: 105 °C	
180954 7.4030 Temperature Switch 	Servicing: Citroen, Ford, Peugeot - Visit www.hc-cargo.com for further information	Thread type: M14-1.25 Working temp.: 110 °C	
180959 7.4042 Temperature Switch 	Servicing: Mercedes-Benz - Visit www.hc-cargo.com for further information	Thread type: M14-1.5 Working temp.: 110 °C	
180963 7.4048 Temperature Switch 	Servicing: Renault - Visit www.hc-cargo.com for further information	Thread type: M14-1.25 Working temp.: 120 °C	
180985 7.4079 Temperature Switch 	Servicing: Alfa Romeo - Visit www.hc-cargo.com for further information	Thread type: M14-1.5 Working temp.: 45 °C	
180986 7.4080 Temperature Switch 	Servicing: Seat, VW - Visit www.hc-cargo.com for further information	Thread type: M10-1 Working temp.: 120 °C	

BRAKE LIGHT SWITCHES
MECHANICAL
180008 Brake Light Switch

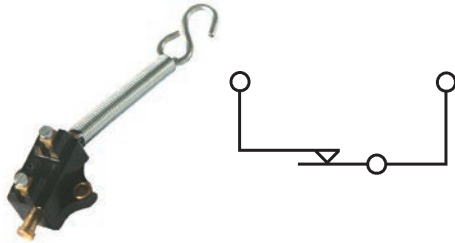
Type: Mechanical

180009 Brake Light Switch

Type: Mechanical

180726 7.1000 Brake Light Switch

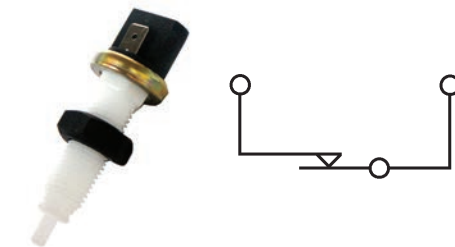
 Servicing: Alfa Romeo, Fiat, Iveco, Lada, Lancia, Polski-Fiat, Seat, Skoda, Zastava - Visit www.hc-cargo.com for further information

Thread type: M12-1.5

Type: Mechanical

180734 7.1014 Brake Light Switch

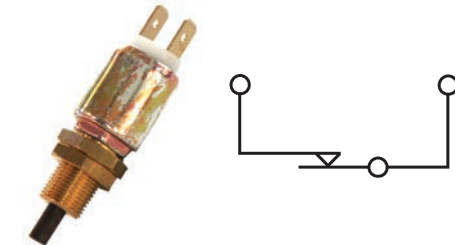
 Servicing: BMW, Lada, Mercedes-Benz, Opel, Saab, Volvo - Visit www.hc-cargo.com for further information

Thread type: M12-1

Type: Mechanical

180753 7.1050 Brake Light Switch

 Servicing: Daewoo, Land Rover, Mercedes-Benz, MG, Nissan, Opel, Volvo - Visit www.hc-cargo.com for further information

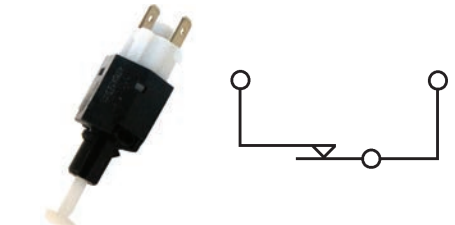
Self-adjustable plunger.

Type: Mechanical

180785 7.1091 Brake Light Switch

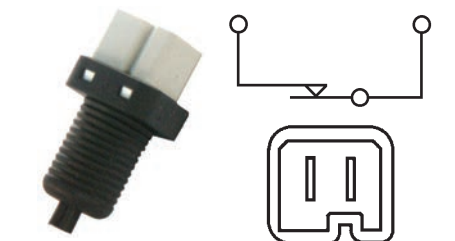
 Servicing: Citroen, Fiat, Lancia, Peugeot - Visit www.hc-cargo.com for further information

Type: Mechanical

181367 7.1149 Brake Light Switch Servicing: Nissan, Renault - Visit www.hc-cargo.com for further information

Self-adjustable plunger.

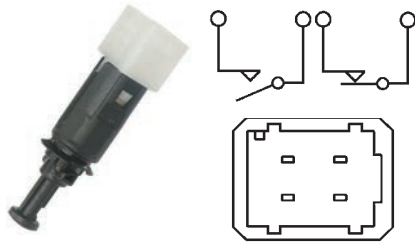

Type: Mechanical

181369 7.1151 Brake Light Switch Servicing: Audi, Ford, Seat, Skoda, VW - Visit www.hc-cargo.com for further information

Self-adjustable plunger.

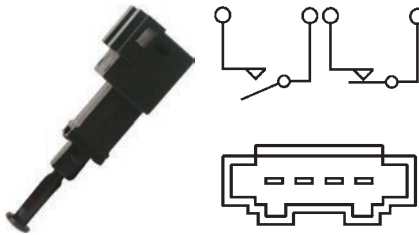

Type: Mechanical

HYDRAULIC

180790 7.1101 Brake Light Switch Servicing: Austin, Fiat, Ford, Jaguar, MAN, MG - Visit www.hc-cargo.com for further information

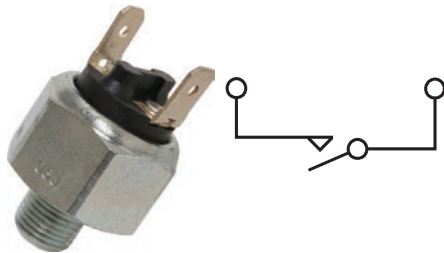

Thread type: 1/8-27
NPT cone

Type: Hydraulic

180791 7.1102 Brake Light Switch Servicing: Audi, Porsche, Skoda, VW - Visit www.hc-cargo.com for further information

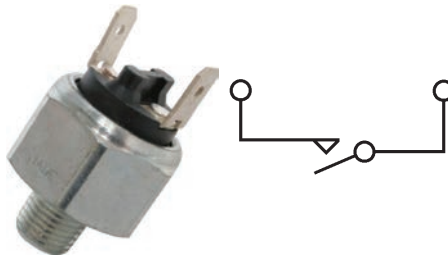

Thread type: M10-1
cone

Type: Hydraulic

REVERSE LIGHT SWITCHES

181147 7.6007 Reverse Light Switch Servicing: Ford, VW - Visit www.hc-cargo.com for further information





Thread type: M14-1.5

181148 7.6009 Reverse Light Switch Servicing: Austin, Rover, Seat, VW - Visit www.hc-cargo.com for further information



Thread type: M12-1.5

	EL. SPECIFICATIONS	DIMENSIONS	ADDITIONAL SPECIFICATIONS
181150 7.6011 Reverse Light Switch 	Servicing: Opel - Visit www.hc-cargo.com for further information	Thread type: M12-1.5	
181152 7.6015 Reverse Light Switch 	Servicing: Citroen, Fiat, Peugeot, Renault, Talbot - Visit www.hc-cargo.com for further information	Thread type: M124-1.5	
181156 7.6019 Reverse Light Switch 	Servicing: Citroen, Fiat, Talbot - Visit www.hc-cargo.com for further information	Thread type: M12-1	
181158 7.6021 Reverse Light Switch 	Servicing: Skoda - Visit www.hc-cargo.com for further information	Thread type: M14-1	
181179 7.6067 Reverse Light Switch 	Servicing: Alfa Romeo, Fiat, Innocenti, Lancia - Visit www.hc-cargo.com for further information	Thread type: M14-1.5	
181182 7.6073 Reverse Light Switch 	Servicing: Alfa Romeo, Chevrolet, Daewoo, Fiat, Lancia, Mercedes-Benz, MG, Mini, Opel, Rover, Saab, Suzuki - Visit www.hc-cargo.com for further information	Thread type: M12-1.5	
181183 7.6075 Reverse Light Switch 	Servicing: M45G	Thread type: M16-2	

	EL. SPECIFICATIONS	DIMENSIONS	ADDITIONAL SPECIFICATIONS
181191 7.6096 Reverse Light Switch 	Servicing: DAF, Mercedes-Benz, Mitsubishi, Nissan, Opel, Renault, Volvo - Visit www.hc-cargo.com for further information	Thread type: M14-1.5	
181194 7.6099 Reverse Light Switch 	Servicing: Audi, Citroen, Fiat, Lancia, Land Rover, Mini, Nissan, Peugeot, Rover, Skoda, VW - Visit www.hc-cargo.com for further information	Thread type: M14-1.5	
181197 7.6102 Reverse Light Switch 	Servicing: Iveco - Visit www.hc-cargo.com for further information	Thread type: M27-1 Thread type 2: M18-1.5	
181201 7.6108 Reverse Light Switch 	Servicing: Citroen, Fiat, Peugeot - Visit www.hc-cargo.com for further information	Thread type: M14-1.5	
181205 7.6113 Reverse Light Switch 	Servicing: Land Rover - Visit www.hc-cargo.com for further information	Thread type: 3/8-16UNC	
181212 7.6125 Reverse Light Switch 	Servicing: Rover, Seat, Skoda, VW - Visit www.hc-cargo.com for further information	Thread type: M12-1.5	
181456 7.6215 Reverse Light Switch 	Servicing: Audi, Ford, Seat, Skoda, VW - Visit www.hc-cargo.com for further information	Thread type: M12-1.5	

THERMO SENSOR SWITCHES
181001 7.5000 Thermo Sensor Switch

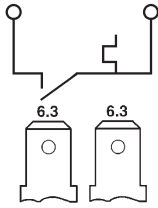
 Servicing: Alfa Romeo, Fiat, Lada, Saab, Seat, Talbot, Zastava - Visit www.hc-cargo.com for further information

 Thread type: M22-1.5
 Working temp.: 92 °C
 Working temp. 2: 87 °C

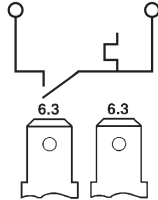
181005 7.5004 Thermo Sensor Switch

 Servicing: Peugeot - Visit www.hc-cargo.com for further information

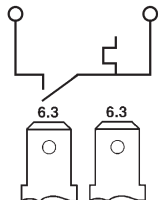
 Thread type: M22-1.5
 Working temp.: 82 °C
 Working temp. 2: 67 °C

181008 7.5007 Thermo Sensor Switch

 Servicing: Citroen, Ford, Peugeot, Renault, Talbot - Visit www.hc-cargo.com for further information

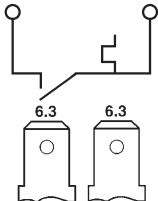
 Thread type: M22-1.5
 Working temp.: 87 °C
 Working temp. 2: 77 °C

181009 7.5008 Thermo Sensor Switch

 Servicing: Alfa Romeo, Peugeot, Renault - Visit www.hc-cargo.com for further information

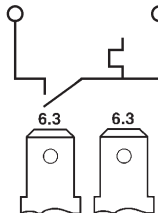
 Thread type: M22-1.5
 Working temp.: 85 °C
 Working temp. 2: 75 °C

181015 7.5018 Thermo Sensor Switch

 Servicing: Citroen - Visit www.hc-cargo.com for further information

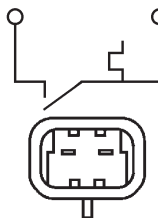
 Thread type: M22-1.5
 Working temp.: 86 °C
 Working temp. 2: 81 °C

181021 7.5031 Thermo Sensor Switch









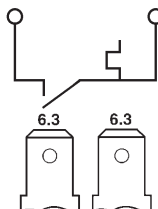

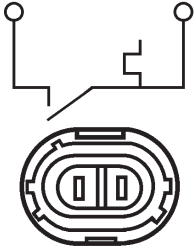
 Servicing: Alfa Romeo, Fiat, Innocenti, Iveco, Lancia - Visit www.hc-cargo.com for further information

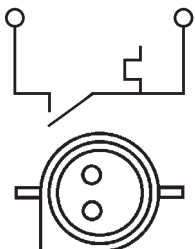
 Thread type: M22-1.5
 Working temp.: 92 °C
 Working temp. 2: 87 °C

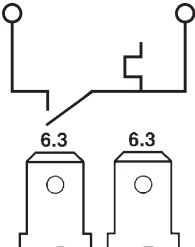
181034 7.5063 Thermo Sensor Switch

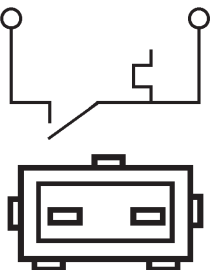
 Servicing: BMW, Opel, Volvo - Visit www.hc-cargo.com for further information

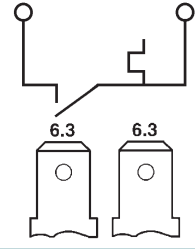
Used w/ HC-CARGO 181033.

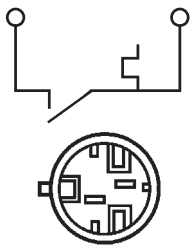

 Thread type: M14-1.5
 Working temp.: 95 °C
 Working temp. 2: 90 °C

EL. SPECIFICATIONS	DIMENSIONS	ADDITIONAL SPECIFICATIONS
181064 7.5128 Thermo Sensor Switch Servicing: Ford, Mercedes-Benz, Opel, Renault - Visit www.hc-cargo.com for further information		
 		Thread type: M22-1.5 Working temp.: 92 °C Working temp. 2: 82 °C
181065 7.5129 Thermo Sensor Switch Servicing: Ford, Renault - Visit www.hc-cargo.com for further information <i>Replacing original grey switch.</i>		
 		Thread type: M22-1.5 Working temp.: 92 °C Working temp. 2: 87 °C
181073 7.5142 Thermo Sensor Switch Servicing: Volvo - Visit www.hc-cargo.com for further information		
 		Thread type: M14-1.5 Working temp.: 72 °C Working temp. 2: 67 °C
181076 7.5145 Thermo Sensor Switch Servicing: Citroen, Fiat, Lancia, Opel, Peugeot - Visit www.hc-cargo.com for further information <i>Replacing original switch w/ yellow ring.</i>		
 		Thread type: M22-1.5 Working temp.: 97 °C Working temp. 2: 92 °C
181077 7.5146 Thermo Sensor Switch Servicing: Volvo - Visit www.hc-cargo.com for further information		
 		Thread type: M14-1.5 Working temp.: 87 °C Working temp. 2: 82 °C
181088 7.5182 Thermo Sensor Switch Servicing: Mercedes-Benz, Opel, Vauxhall - Visit www.hc-cargo.com for further information		
 		Thread type: M22-1.5 Working temp.: 100 °C Working temp. 2: 95 °C

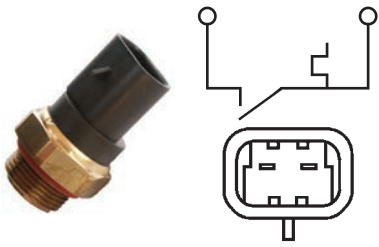
EL. SPECIFICATIONS
DIMENSIONS
ADDITIONAL SPECIFICATIONS
181089 7.5187 Thermo Sensor Switch

 Servicing: Citroen, Fiat, Iveco, Lancia, Peugeot - Visit www.hc-cargo.com for further information

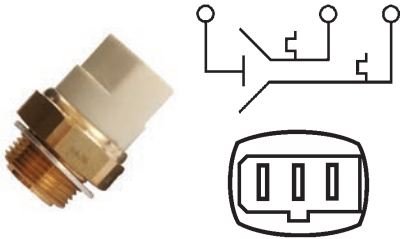
 Thread type: M22-1.5
 Working temp.: 92 °C
 Working temp. 2: 87 °C

DOUBLE FAN OR TWO SPEED MOTORS
181121 7.5626 Thermo Sensor Switch

 Servicing: Audi, VW - Visit www.hc-cargo.com for further information

 Thread type: M22-1.5
 Working temp.: 87-77 °C
 Working temp. 2: 92-82 °C

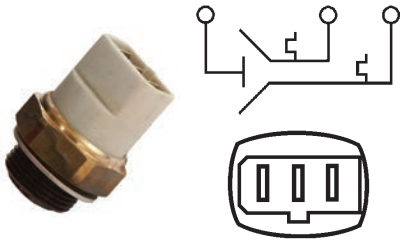
 Double fan: Yes
 2 speed: Yes

181126 7.5635 Thermo Sensor Switch

 Servicing: Audi, Opel, Seat, Skoda, VW - Visit www.hc-cargo.com for further information

 Thread type: M22-1.5
 Working temp.: 95-85 °C
 Working temp. 2: 102-92 °C

 Double fan: Yes
 2 speed: Yes

SENSORS
TEMPERATURE SENSORS
WATER
160786 Temp. Transmitter

Servicing: HC-CARGO 160699, 160778



Voltage: 12-24

Thread type: 1/8 NPTF

180804 7.3000 Temperature Sensor
For water.

 Thread type: M16-1.5
 cone

180808 7.3005 Temperature Sensor
For water.

 Thread type: 1/8-27
 NPT cone

180820 7.3028 Temperature Sensor

Replace original yellow sensor. For water.



Thread type: 1/8-27
NPT cone

180839 7.3073 Temperature Sensor

For water.



Thread type: M10-1

180848 7.3086 Temperature Sensor

Replacing original black sensor. For water.



180883 7.3146 Temperature Sensor

Replacing original black and yellow sensor. For water.



180893 7.3165 Temperature Sensor

Replacing original black sensor. For water.



Thread type: 1/8-27
NPT

181400 7.3258 Temperature Sensor

Replace original green sensor. For water.



ENGINE

180861 7.3101 Temperature Sensor

Replacing original blue sensor. For engine.



Thread type: M16-1

180875 7.3128 Temperature Sensor
Replacing original blue sensor. For engine.

Thread type: M12-1.5

180905 7.3191 Temperature Sensor
Replacing original white sensor. For engine.

Thread type: M12-1.5

181373 7.3308 Temperature Sensor
For motor.

Thread type: M14-1.25

181395 7.3239 Temperature Sensor
For motor.

Thread type: M12-1.5

OIL PRESSURE SENSORS
160787 Oil Pressure Sensor

Servicing: HC-CARGO 160700, 160779



Voltage: 12-24





Thread type: 1/8 NPTF

180702 7.0602 Oil Pressure Sensor

 Thread type: M14-1.5
 Working area: 0-8 bar

TIMING SENSORS
CRANKSHAFTS
150332 Crankshaft Position Sensor

Ohm: 780

	EL. SPECIFICATIONS	DIMENSIONS	ADDITIONAL SPECIFICATIONS
<p>150336 Crankshaft Position Sensor</p> 	Ohm: 170		
<p>150340 Crankshaft Position Sensor</p> 	Ohm: 240		
<p>150343 Crankshaft Position Sensor</p> 	Ohm: 370		
<p>150354 Crankshaft Position Sensor</p> 	Ohm: 530		
<p>150360 Crankshaft Position Sensor</p> 	Ohm: 950		
<p>150361 Crankshaft Position Sensor</p> 	Ohm: 530		
<p>150366 Crankshaft Position Sensor</p> 	Ohm: 370		

150404 Crankshaft Position Sensor



Ohm: 250

150414 Crankshaft Position Sensor



Ohm: 250

150445 Crankshaft Position Sensor

Servicing: VW, Seat - Visit www.hc-cargo.com for further information

Hall effect.



150451 Crankshaft Position Sensor



Ohm: 900

150468 Crankshaft Position Sensor



Ohm: 900

150470 Crankshaft Position Sensor



Ohm: 900

CAMSHAFTS

150496 Camshaft Position Sensor

Servicing: Volvo, Renault - Visit www.hc-cargo.com for further information

Hall effect.





Assortments

Edition 2014/2015



ASSORTMENTS
BOXES
200663 Assortment Box
Can be divided using inserts.

 Length: 265 m
 Thickness: 57 mm
 Width: 340 mm

Material: Polypropylene

200875 Carry Lite Assortment Box

 Length: 413 m
 Thickness: 57 mm
 Width: 330 mm

 Colour: Anthracite
 Material: Polypropylene

200876 Carry Lite Assortment Box
80-01.

 Length: 413 m
 Thickness: 79 mm
 Width: 330 mm

 Colour: Anthracite
 Material: Polypropylene

200877 Carry Lite Assortment Box

 Length: 413 m
 Thickness: 147 mm
 Width: 330 mm

 Colour: Anthracite
 Material: Polypropylene

200878 Foam

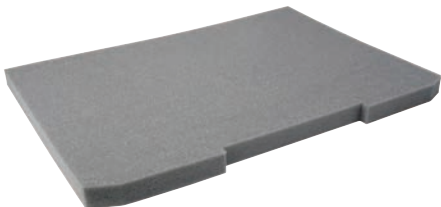
 Servicing: Carry Lite - Visit www.HC-CARGO.com for further information

 Length: 389 m
 Thickness: 22 mm
 Width: 284 mm

 Colour: Anthracite
 Material: Plastic

200879 Rail Set
For CL-box.

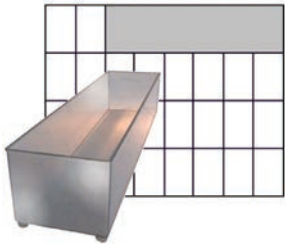

INSERTS			
200664 Insert			
<i>Unbreakable.</i>			
		Length: 40.00 m Thickness: 45.00 mm Width: 55.00 mm	Material: Polypropylene
200665 Insert			
<i>Unbreakable.</i>			
		Length: 110.00 m Thickness: 45.00 mm Width: 40.00 mm	Material: Polypropylene
200666 Insert			
<i>Unbreakable.</i>			
		Length: 165.00 m Thickness: 45.00 mm Width: 40.00 mm	Material: Polypropylene
200667 Insert			
<i>Unbreakable.</i>			
		Length: 220.00 m Thickness: 45.00 mm Width: 40.00 mm	Material: Polypropylene
200668 Insert			
<i>Unbreakable.</i>			
		Length: 80.00 m Thickness: 45.00 mm Width: 55.00 mm	Material: Polypropylene
200669 Insert			
<i>Unbreakable.</i>			
		Length: 160.00 m Thickness: 45.00 mm Width: 55.00 mm	Material: Polypropylene

200670 Insert
Unbreakable.

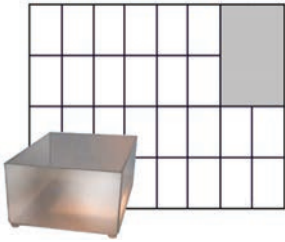
 Length: 240.00 m
 Thickness: 45.00 mm
 Width: 55.00 mm

Material: Polypropylene

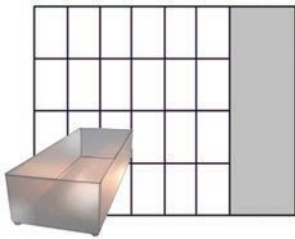
200671 Insert
Unbreakable.

 Length: 110.00 m
 Thickness: 45.00 mm
 Width: 80.00 mm

Material: Polypropylene

200672 Insert
Unbreakable.

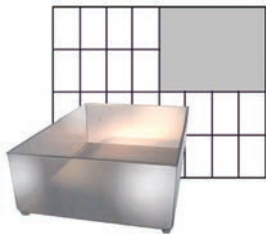
 Length: 220.00 m
 Thickness: 45.00 mm
 Width: 80.00 mm

Material: Polypropylene

200673 Insert
Unbreakable.

 Length: 160.00 m
 Thickness: 45.00 mm
 Width: 110.00 mm

Material: Polypropylene

DISPLAY
200676 Display for 4 Assortments
Frame for 4 Profi service cases.

 Length: 200.00 m
 Thickness: 330.00 mm
 Width: 360.00 mm

200693 Assortment Display
Frame for 4 Profi service cases. Can be assembled horizontally or vertically.

 Length: 265.00 m
 Thickness: 313.00 mm
 Width: 373.00 mm

Thermal Washers

806011

	Qty.		Qty.
080296	10	080439	10
080424	10	080440	10
080425	10	080441	10
080426	10	080442	10
080427	10	080443	10
080428	10	080444	10
080429	10	080446	10
080430	10	080447	10
080431	10	080448	10
080432	10	080449	10
080433	10	080450	10
080434	10	080452	10
080435	10	080453	10
080436	10	080454	10
080437	10	080456	10
080438	10	080688	10

Ring Nipples & Hose Sleeves

806015

	Qty.		Qty.
080259	10	080245	5
080260	10	080246	5
080261	10	080247	5
080262	10		
080263	10		
080264	10		
080265	10		
080237	5		
080238	5		
080239	5		
080240	5		
080241	5		
080242	5		
080243	5		

Hollow Screws & Hose Nipples

806020

	Qty.		Qty.
080003	3	080242	3
080251	5	080243	3
080252	5	080246	3
080253	5	080247	3
080254	5		
080255	10		
080256	10		
080257	10		
080258	10		
080237	3		
080238	3		
080239	3		
080240	3		
080241	3		

Glow Plugs

806030

	Qty.
100261	4
100335	4
100515	4
100527	4
100531	4
100532	4
100537	4
100538	4
100545	4
100555	4
100557	4
100563	4
100592	4
100593	4





Workshop Consumables

Edition 2014/2015



CRIMP TERMINALS

INSULATED

FEMALE SPADE

RED		BLUE		YELLOW	
0.25-1.6 mm ²	9/0.3-21/0.3 mm	1-2.6 mm ²	21/0.3-44/0.3 mm	2.6-6.6 mm ²	44/0.3-84/0.3 mm
	HC-CARGO	Width	ID	Colour	Type
	190049	2.8 mm	1.7-4.3 mm	Red	Female, Flat
	192795	2.8 mm	2.3-5 mm	Blue	Female, Flat
	192825	4.5 x 0.5 mm	2.3-5 mm	Blue	Female, Flat
	190045	4.7 mm	1.7-4.3 mm	Red	Female, Flat
	190024	6.3 mm	3.4-6.5 mm	Yellow	Female, Flat
	190020	6.3 mm	2.3-5 mm	Blue	Female, Flat
	190022	6.3 mm	1.7-10 mm	Red	Female, Flat
	190041	8 mm	2.3 mm	Blue	Female
	190048	9.5 mm	3.4-6.5 mm	Yellow	Female, Flat

FULLY INSULATED

	HC-CARGO	Width	ID	Colour	Type
	192226	4.7 mm	1.7-4.3 mm	Red	Female, Flat
	190046	6.3 mm	2.3-5 mm	Blue	Female, Flat
	190985	6.3 mm	1.7-4.3 mm	Red	Female, Flat
	192036	6.3 mm	3.4-6.5 mm	Yellow	Female, Flat

FEMALE SPADE & PIGGY BACK SPADE

	HC-CARGO	Width	ID	Colour	Type
	190025	6.3 mm	1.7-4.3 mm	Red	Female, Spade w/piggyback
	190026	6.3 mm	2.3-5 mm	Blue	Female, Spade w/piggyback

SPADE

	HC-CARGO	Width	ID	Colour	Type
	192449	2.8 mm	1.7 mm	Red	Male, Flat
	190016	6.3 mm	2.3-5 mm	Blue	Male, Flat
	190019	6.3 mm	1.7-4.3 mm	Red	Male, Flat
	191191	6.3 mm	3.4 mm	Yellow	Male, Flat

FEMALE BULLET

	HC-CARGO	Width	ID	Colour	Type
	190017	4 mm	1.7-4.3-4 mm	Red	Female, Round
	190018	5 mm	2.3-5-5 mm	Blue	Female, Round
	190050	5 mm	3.4 mm	Yellow	Female, Round

BULLET

	HC-CARGO	Width	ID	Colour	Type
	190021	4 mm	1.7-4.3 mm	Red	Round, Red
	190023	5 mm	2.3-5 mm	Blue	Round
	190051	5 mm	3.4 mm	Yellow	Round

BUTT CONNECTOR					
	HC-CARGO	Width	ID	Colour	Type
	190028	4.1 mm	1.7-4.1 mm	Red	Butt splices
	190001	4.5 mm	3.2-4.5 mm	Blue	Butt splices
	190030	6.5 mm	3.6-6.5 mm	Yellow	Butt splices
RING					
	HC-CARGO	Width	ID	Colour	Type
	190038	6 mm	1.6-4.5 mm	Red	Ring
	190257	6 mm	2.3-5 mm	Blue	Ring
	190027	6 mm	1.6-4.5 mm	Red	Ring
	190029	7.8 mm	2.3-5 mm	Blue	Ring
	190033	9.9 mm	3.6-6.8 mm	Yellow	Ring
	190031	10 mm	1.6-4.5 mm	Red	Ring
	190032	10 mm	2.3-5 mm	Blue	Ring
	190015	10.8 mm	1.6-4.5 mm	Red	Ring
	190034	11 mm	2.3-5 mm	Blue	Ring
	190035	11 mm	3.6-6.8 mm	Yellow	Ring
	190255	13.8 mm	3.6-6.8 mm	Yellow	Ring
	192352	14 mm	1.6-4.5 mm	Red	Ring
	190039	14 mm	2.3-5 mm	Blue	Ring
	190042	17.8 mm	3.6-6.8 mm	Yellow	Ring
	192354	18 mm	2.3-5 mm	Blue	Ring
191515	19 mm	3.4 mm	Yellow	Ring	
192353		1.6-4.5 mm	Red	Ring	
FORK					
	HC-CARGO	Width	ID	Colour	Type
	191501	2 mm	3.5 mm	Red	Lever
	190973	4 mm	3.7 mm	Red	Lever
	191067	4 mm	4.9 mm	Blue	Lever
	191696	5 mm	3.4 mm	Yellow	Lever
	190037	5 mm	2.3 mm	Blue	Lever
	192950	5 mm	3.4 mm	Yellow	Lever
	192142	6 mm	3.4 mm	Yellow	Lever
FORK W/ FLANGE					
	HC-CARGO	Width	ID	Colour	Type
	192370	4 mm	2.3 mm	Blue	Lever w/ flange
	192371	5 mm	2.3 mm	Blue	Lever w/ flange
PIN					
	HC-CARGO	Width	ID	Colour	Type
	190952	1.9 mm	2.3 mm	Blue	Pin
	190974	1.9 mm	1.7 mm	Red	Pin
	190953	2.8 mm	3.4 mm	Yellow	Pin

TERMINATORS-HEAT-SHRINCABLE W/ SOLDER

FEMALE SPADE, FULLY INSULATED

	HC-CARGO	Width	Crimp temp.	Temp. area	Colour	Type
	191697	6.3 mm	150°C	10°C - 105°C	Red	Female, Flat
	191698	6.3 mm	150°C	10°C - 105°C	Blue	Female, Flat

SPADE

	HC-CARGO	Width	Crimp temp.	Temp. area	Colour	Type
	191699	6.3 mm	150°C	10°C - 105°C	Red	Male, Flat
	191700	6.3 mm	150°C	10°C - 105°C	Blue	Male, Flat

BUTT CONNECTOR

	HC-CARGO	Width	Crimp temp.	Temp. area	Colour	Type
	192929	5.4 mm	min. +85°C	-55°C - +125°C	Red	Butt splices
	191009	6 mm	min. +85°C	-55°C - +125°C	Red	Butt splices
	192930	6.7 mm	min. +85°C	-55°C - +125°C	Blue	Butt splices
	191010	6.8 mm	min. +85°C	-55°C - +125°C	Blue	Butt splices
	192931	7.9 mm	min. +85°C	-55°C - +125°C	Yellow	Butt splices
	191011	8.6 mm	min. +85°C	-55°C - +125°C	Yellow	Butt splices

RING

	HC-CARGO	Width	Crimp temp.	Temp. area	Colour	Type
	191682	4 mm	150°C	10°C - 105°C	Red	Ring
	191685	4 mm	150°C	10°C - 105°C	Blue	Ring
	191683	5 mm	150°C	10°C - 105°C	Red	Ring
	191686	5 mm	150°C	10°C - 105°C	Blue	Ring
	191689	5 mm	150°C	10°C - 105°C	Yellow	Ring
	191684	6 mm	150°C	10°C - 105°C	Red	Ring
	191687	6 mm	150°C	10°C - 105°C	Blue	Ring
	191690	6 mm	150°C	10°C - 105°C	Yellow	Ring
	191688	8 mm	150°C	10°C - 105°C	Blue	Ring
	191691	8 mm	150°C	10°C - 105°C	Yellow	Ring
	191692	10 mm	150°C	10°C - 105°C	Yellow	Ring

FORK

	HC-CARGO	Width	Crimp temp.	Temp. area	Colour	Type
	191693	4 mm	150°C	10°C - 105°C	Red	Lever
	191694	4 mm	150°C	10°C - 105°C	Blue	Lever
	191695	5 mm	150°C	10°C - 105°C	Blue	Lever

HEAT-SHRINCABLE W/GLUE

SOLDER SLEEVE

	HC-CARGO	OD/ cable	Crimp temp.	Temp. area	Colour	Type
<i>Solder sleeve wire to wire splicing w/ fluxed solder and heat shrinkable thermoplastic sleeve.</i>						
	193237	1.7 mm	min. +85°C	-55°C - +125°C	Transparent	Butt splices, Crimp
	191701	2.7 mm	min. +85°C	-55°C - +125°C	Red	Butt splices, Crimp
	191702	4.5 mm	min. +85°C	-55°C - +125°C	Blue	Butt splices, Crimp
	191703	6 mm	min. +85°C	-55°C - +125°C	Yellow	Butt splices, Crimp

MULTIWIRE SPLICE

	HC-CARGO	Cable multicore	Crimp temp.	Temp. area	Colour	Type
<i>Solder grip multiwire splices up to 10 wires of different sizes and can be combined w/ fluxed solder and heat shrinkable thermoplastic sleeve.</i>						
	191704	3.1 mm	min. +85°C	-55°C - +125°C	Green	
	191708	3.6 mm	min. +85°C	-55°C - +125°C	Green	
	191705	3.9 mm	min. +85°C	-55°C - +125°C	Red	
	191713	3.9 mm	min. +85°C	-55°C - +125°C	Green	Ring
	191709	5 mm	min. +85°C	-55°C - +125°C	Red	
	191706	5.35 mm	min. +85°C	-55°C - +125°C	Blue	
	191707	7.15 mm	min. +85°C	-55°C - +125°C	Yellow	
	191710	7.5 mm	min. +85°C	-55°C - +125°C	Blue	
	191711	9.4 mm	min. +85°C	-55°C - +125°C	Yellow	

NON INSULATED

FLAT SPADE

	HC-CARGO	Width	Cable size	Non return tag	Type
	192174	0.4x1.5 mm	0.35 mm ²	w/	Male, Junior Timer
	192089	1.5 mm	1x1.5 mm ²	w/o	Male, Super Seal Connector
	192410	1.8 mm	0.5x1.25 mm ²	w/o	Male, Type 070 M280
	192528	2.3 mm	0.5x1.25 mm ²	w/	Male, MT- serie 090
	192645	2.3 mm	0.5x1.25 mm ²	w/	Male, TS sealed-serie
	192217	2.7 mm	0.5x1 mm ² / 1.6x0.8 mm	w/	Male, Micro Timer II
	192503	2.8x0.8 mm	0.5x1 mm ²	w/	Male, Junior Power Timer
	191681	2.8 mm	0.5-1 mm ²	w/	<i>Universal. For car radio.</i> Male, M280
	192240	2.8 mm	0.5x1.5 mm ²	w/o	Male, Mark II
	192373	2.8 mm	0.5x1.5 mm ²	w/o	Male, Metripack M280
	191807	3 mm	1x3 mm ²	w/	Male, MIC I
	191129	4.7 mm	0.5-1.5 mm ²	w/	Male, Flat, For insulator For multiplug
	192156	5 mm	0.5x1 mm ²	w/	Male, Junior Power Timer
	192157	5 mm	1.5x2.5 mm ²	w/	Male, Junior Power Timer
	191549	6.3 mm	0.3x0.8 mm ²	w/	Male, Flat, For insulator For multiplug
	192380	6.3 mm	0.5x2 mm ²	w/	Male, Flat, Tin plated Japanese type For insulator For multiplug
	190270	6.3 mm	1-2.5 mm ²	w/	Male, Flat, For insulator For multiplug
	191415	6.3 mm	1-2.5 mm ²	w/o	Male, Flat, Tin plated For insulator
	191028	6.3 mm	4x6 mm ²	w/	Male, Flat, Tin plated For insulator For multiplug

FEMALE SPADE

	HC-CARGO	Width	Cable size	Non return tag	Type
	192786	1 mm	0.3x0.5 mm ²	w/o	Female, Type 040 Tin plated
	192090	1.5 mm	1-1.5 mm ²	w/o	Female, Super Seal Connector
	192529	2.3 mm	0.5x1.25 mm ²	w/	Female, MT- serie 090
	192646	2.3 mm	0.5x1.25 mm ²	w/	<i>090 terminal.</i> Female, TS sealed-serie
	192239	2.8 mm	0.5-1.5 mm ²	w/o	<i>For tail lamps.</i> Female, Mark II

	HC-CARGO	Width	Cable size	Non return tag	Type
	191083	2.8 mm	0.5-1 mm ²	w/	Female, Flat, For multiplug
	192411	2.8 mm	0.5x1.25 mm ²	w/o	Female, Type 070 F280
	192374	2.8 mm	0.5x1.5 mm ²	w/o	Female, Metripack F280
	191806	3 mm	1-3 mm ²	w/	Female, MIC I
	192140	3.3 mm	0.5x1 mm ² / 1.6x0.8 mm	w/	Female, Micro Timer II
	191551	4 mm	0.5x1.5 mm ² / 2.8x0.8 mm	w/	Female, Junior Timer
	192175	4.3 mm	0.5x1 mm ² / 2.8x0.8 mm	w/	Female, Junior Power Timer
	192155	4.5 mm	1.5x2.5 mm ² / 2.8x0.8 mm	w/	Female, Junior Timer
	191089	4.8 mm	0.5-1 mm ²	w/	Female, Flat, Tin plated For multiplug
	192443	4.8 mm	0.5-1 mm ²	w/o	Female, Flat For insulator
	192573	4.8 mm	0.5-1 mm ²	w/o	Female, Flat, Tin plated For insulator
	192998	5.3 mm	1.5-2.5 mm ²	w/	Female, Straight Tin plated For multiplug
	192986	5.5 mm		w/	Servicing: 192794 Female, Flat
	192176	6 mm	1x2.5 mm ² / 2.8x0.8 mm	w/	Female, Junior Power Timer
	192772	6.3 mm		w/o	PC board
	191246	6.3 mm	0.5-1.5 mm ²	w/o	Female, Positive lock
	190868	6.3 mm	0.5-1 mm ²	w/	Female, Flat For multiplug
	192001	6.3 mm	0.5-1 mm ²	w/o	<i>Form B.</i> Female, Flat
	192574	6.3 mm	0.5-1 mm ²	w/o	Female, Flat Tin plated For insulator
	192377	6.3 mm	0.5x1 mm ²	w/	Female, Flat Tin plated For multiplug
	192381	6.3 mm	0.5-2 mm ²	w/o	Female, Flat Tin plated Japanese type For insulator For multiplug
	190252	6.3 mm	1-2.5 mm ²	w/	Female, Flat For multiplug
	191008	6.3 mm	1-2.5 mm ²	w/o	Female, Flat For insulator
	191248	6.3 mm	1-2.5 mm ²	w/o	Female, Positive lock
	192376	6.3 mm	1x2.5 mm ²	w/	Female, Flat Tin plated For multiplug
	191064	6.3 mm	2.5-6 mm ²	w/o	Female, Flat For insulator
	191029	6.3 mm	2.5x6 mm ²	w/	<i>Preformed.</i> Female, Flat For multiplug
	190725	6.3 mm	<2.5 mm ²	w/o	<i>Fits Cargo 190733.</i> Female, Flat Tin plated
	191247	7.3 mm	2.5-4 mm ²	w/o	Female, Positive lock
	191260	8 mm	1-2.5 mm ²	w/o	Female, Positive lock Power connectors
	191200	8 mm	1x2.5 mm ²	w/	<i>Fits Cargo 170619.</i> Female, Flat Tin plated For multiplug



	HC-CARGO	Width	Cable size	Non return tag	Type
	191261	8 mm	4x6 mm ²	w/o	Female, Positive lock Power connectors
	191262	8 mm	6x10 mm ²	w/o	Female, Positive lock Power connectors
	191938	9.1 mm	1-2.5 mm ²	w/	Female, Flat Tin plated
	191025	9.5 mm	2-4 mm ²	w/	Female, Flat Tin plated For multiplug
	191069	9.5 mm	2-4 mm ²	w/o	Female, Flat For insulator
	190726	9.5 mm	3-6 mm ²	w/o	<i>Fits Cargo 190733.</i> Female, Flat

ADAPTERS

	HC-CARGO	Width	Cable size	Non return tag	Type
	191082		0.5-2.5 mm ²		<i>Content: 1x HC-CARGO 191078, x HC-CARGO 191079, 1x HC-CARGO 191080, 1x HC-CARGO 191081.</i> Tin plated
	190256	6.3 mm	0.5-2.5 mm ²	w/o	Adaptor, Spade w/piggyback
	192575	6.3 mm	0.5-2.5 mm ²	w/o	Adaptor, Triple Tin plated
	192383	6.3 mm	1-2.5 mm ²	w/o	Adaptor, Spade w/piggyback

LEAF SPRING TERMINALS

	HC-CARGO	Width	Cable size	Non return tag	Type
	192236	6.5 mm	0.5x1 mm ²	w/	Female, Blade fuse
	192237	6.5 mm	1.5x2.5 mm ²	w/	Female, Blade fuse

TIMER TERMINALS

	HC-CARGO	Width	Cable size	Non return tag	Type
	191556	6.8 mm	1-2.5 mm ²	w/	Female, Standard timer
	192485		2.5-4 mm ²	w/	Female, Maxi Power Timer
	192486	11.2 mm	4-6 mm ²	w/	Female, Maxi Power Timer

MALE & FEMALE BULLETS

	HC-CARGO	Width	Cable size	Non return tag	Type
	191915	3.4 mm	0.3-0.9 mm ²	w/	Male, Round
	191916	3.2 mm	0.3-0.9 mm ² /1 mm	w/	Mini, Female, Round
	191078	3.96 mm	0.5-2.5 mm ²		Male, Round Tin plated
	191079	3.96 mm	0.5-2.5 mm ²		Female, Round Tin plated
	191985	4 mm	0.7-1.5 mm ²	w/	Male, Round
	191074	4 mm	1-2.5 mm ²	w/	Male, Round
	191091	4.2 mm	0.5-2.1 mm ²	w/	Male, Round
	191075	4.2 mm	1-2.5 mm ²	w/	Female, Round
	191543	4.2 mm	1-2.5 mm ²	w/	Male, Round
	191544	4.2 mm	1-2.5 mm ² / 1.6 mm	w/	Female, Round
	191092	4.3 mm	0.5-2.1 mm ²	w/	Female, Round
	191564	5.7 mm	0.5-2 mm ²	w/	Female, Round
	191563	6.1 mm	0.5-2 mm ²	w/	Male, Round

MALE & FEMALE DEUTCH

	HC-CARGO	Cable size	Non return tag	Type
	192619	0.2-0.5 mm ²	w/o	Male, Round
	192620	0.2-0.5 mm ²	w/o	Female, Round
	192505	0.75-1.25 mm ²	w/o	DEUTSCH, Male, Round
	192506	0.75-1.25 mm ²	w/o	DEUTSCH, Female, Round
	192477		w/o	DEUTSCH, Male, Round
	192478	1.25-2 mm ²	w/o	DEUTSCH, Female, Round
	193234	13 mm ²	w/o	DEUTSCH, Male, Round
	193236	13 mm ²	w/o	DEUTSCH, Female, Round
	192621	2-3 mm ²	w/o	DEUTSCH, Male, Round
	192622	2-3 mm ²	w/o	DEUTSCH, Female, Round
	193233	5-8 mm ²	w/o	DEUTSCH, Male, Round
	193235	5-8 mm ²	w/o	DEUTSCH, Female, Round

WEATHERPROOF CONNECTOR TERMINALS

	HC-CARGO	Cable size	Non return tag	Type
	191168	1-2.5 mm ²	w/o	Female, ABS
	191171	1.5-2.5 mm ²	w/o	Male, ABS
	192180	1.5-2.5 mm ²	w/o	Female, ABS, For multiplug
	191196	1.5 mm ²	w/o	Male, ABS
	191169	4-6 mm ²	w/o	Female, ABS
	191172	4-6 mm ²	w/o	Male, ABS
	191197	4 mm ²	w/o	Male, ABS
	192181	4 mm ²	w/o	Female, ABS, For multiplug

PINS

	HC-CARGO	Width	Cable size	Non return tag	Type
	192552	5.6 mm	2.5-4 mm ²	w/o	Pin
	191855	5.4 mm	2.6-4 mm ²	w/o	Pin
	193120	5.7 mm	4-6 mm ²	w/o	Pin, Round
	191801	1.9 mm	1-2.5 mm ²	w/o	Pin

SPRING TERMINALS

	HC-CARGO	Width	Cable size	Non return tag	Type
	191870	5.3 mm	1-1.5 mm ²	w/	<i>Heavy duty.</i> Female, Blade fuse holder
	191412	5.3 mm	1-2.5 mm ²	w/	Female, Blade fuse holder
	191871	5.3 mm	2.5-4 mm ²	w/	<i>Heavy duty.</i> Female, Blade fuse holder
	191411	6.3 mm		w/	<i>To be connected w/ 6.3 mm flat tongue terminal.</i> Female, Blade fuse holder
	191413	6.5 mm	2.5-6 mm ²	w/	Female, Blade fuse holder
	191872	6.5 mm	4-5 mm ²	w/	<i>Heavy duty.</i> Female, Blade fuse holder

FOR POWR-BLOKS

	HC-CARGO	Width	Cable size	Non return tag	Type
	191733	8.4 mm	1-2.5 mm ²	w/o	Female, Spring
	191734	8.2 mm	1-2.5 mm ²	w/o	Female, Spring
	192758	8.2 mm	1-2.5 mm ²	w/o	<i>For HC-CARGO 191717, 191718, 191179. Heavy duty.</i> Female, Spring

CRIMP TERMINALS						
	HC-CARGO	Width	Cable size	Non return tag	Type	
	191735	9.7 mm	1.5-4 mm ²	w/o	<i>Maxi fuse module:</i> HC-CARGO 191721. Female, Powr-bloks	
	191739	2.8 mm	1-2.5 mm ²	w/o	Female, Powr-bloks	
	191740	2.8 mm	2.5-4 mm ²	w/o	Female, Powr-bloks	
	191737	4.7 mm	0.8-1.5 mm ²	w/o	<i>Micro relay:</i> HC-CARGO 191724. Female, Powr-bloks	
	191738	4.7 mm	1.5-4 mm ²	w/o	<i>Micro relay:</i> HC-CARGO 191724. Female, Powr-bloks	
	191764	6.3 mm	0.5x0.8 mm ²	w/	Female, Flat	
	191765	6.3 mm	1.3x2.1 mm ²	w/	Female, Flat	
	191766	6.3 mm	3.3x5.5 mm ²	w/	Female, Flat	
RING TERMINALS						
	HC-CARGO	Width	Cable size	ID	Non return tag	Type
	192003	5.3 mm	0.8x2 mm ²	5.3 mm	w/o	Ring
	191030	5.6 mm	0.8-2 mm ²	4.3 mm	w/o	Ring
	192004	6.4 mm	0.8-2.5 mm ²	6.4 mm	w/o	Ring
	192005	7.3 mm	2-4 mm ²	8.4 mm	w/o	Ring
FLAG RING TERMINALS						
	HC-CARGO	Width	Cable size	ID	Non return tag	Type
	191050	10 mm	0.3-1.7 mm ²	4.3 mm	w/o	Ring, Angled
	191051	10 mm	0.3-1.7 mm ²	5.3 mm	w/o	Ring, Angled
	191856	16 mm	10.5-16.8 mm ²	8.3 mm	w/o	Ring, Angled
CABLE JOINTS RING						
	HC-CARGO	Bolt size	Cable size	Type		
	192975	M3	0.5-1.5 mm ²	Ring, Solder, Tin plated		
	191060	M4	0.25-1 mm ²	Ring, Tin plated		
	192134	M5	2.5-6 mm ²	Ring, Tin plated		
	192135	M5	5-10 mm ²	Ring, Tin plated		
	190716	M6	10 mm ²	Ring, Tin plated		
	190717	M6	16 mm ²	Ring, Tin plated		
	190846	M6	4-6 mm ²	Ring, Tin plated		
	190718	M8	16 mm ²	Ring, Tin plated		
	190719	M8	25 mm ²	Ring, Tin plated		
	191416	M8	35 mm ²	Ring, Tin plated		
	190722	M8	50 mm ²	Ring, Tin plated		
	191049	M8	8-10 mm ²	Ring, Tin plated		
	192557	M10	16 mm ²	Ring, Tin plated		
	190720	M10	25 mm ²	Ring, Tin plated		
	190721	M10	35 mm ²	Ring, Tin plated		
	190723	M10	50 mm ²	Ring, Tin plated		

CABLE LUGS RING

	HC-CARGO	Bolt size	Cable size	Type
	192905	M6	4-6 mm ²	Straight, Solder Tin plated
	192908	M6	6-10 mm ²	Straight, Single Tin plated
	192911	M6	10-16 mm ²	Straight, Solder Tin plated
	192915	M6	16-25 mm ²	Straight, Solder Tin plated
	192919	M6	25-35 mm ²	Straight, Solder Tin plated
	192906	M8	4-6 mm ²	Straight, Solder Tin plated
	192912	M8	10-16 mm ²	<i>Replaces HC-CARGO 191841.</i> Straight, Solder Tin plated
	192916	M8	16-25 mm ²	Straight, Solder Tin plated
	192920	M8	25-35 mm ²	Straight, Solder Tin plated
	192923	M8	35-50 mm ²	Straight, Solder Tin plated
	192909	M8	6-10 mm ²	<i>Replaces HC-CARGO 191838.</i> Straight, Solder Tin plated
	192926	M8	50-70 mm ²	Straight, Solder Tin plated
	192907	M10	4-6 mm ²	Straight, Solder Tin plated
	192910	M10	6-10 mm ²	Straight, Solder Tin plated
	192913	M10	10-16 mm ²	Straight, Solder Tin plated
	192917	M10	16-25 mm ²	Straight, Solder Tin plated
	192921	M10	25-35 mm ²	<i>Replaces HC-CARGO 191847.</i> Straight, Solder Tin plated
	192924	M10	35-50 mm ²	Straight, Solder Tin plated
	192927	M10	50-70 mm ²	Straight, Solder Tin plated
	192932	M10	95 mm ²	Ring, Straight Tin plated
	191884	M12	10 mm ²	Ring, Tin plated
	192914	M12	10-16 mm ²	Straight, Solder Tin plated
	192918	M12	16-25 mm ²	Straight, Solder Tin plated
	192922	M12	25-35 mm ²	Straight, Solder Tin plated
	192925	M12	35-50 mm ²	Straight, Solder Tin plated
	192928	M12	50-70 mm ²	Straight, Solder Tin plated
	192933	M12	95 mm ²	Straight, Single Tin plated

BUTT SPLICES

	HC-CARGO	Cable size	Type
	192007	1.3 mm ²	Tin plated
	192008	2 mm ²	Tin plated
	191885	6 mm ²	Tin plated
	191886	10 mm ²	Tin plated
	191887	16 mm ²	Tin plated
	191888	25 mm ²	Tin plated
	191889	35 mm ²	Tin plated
	191890	60 mm ²	Tin plated
	191891	70 mm ²	Tin plated
	193168	80 mm ²	Tin plated

CORD END TERMINALS

	HC-CARGO	Cable size
	191962	0.5 mm ²
	191963	0.75 mm ²
	191964	1 mm ²
	191965	1.5 mm ²
	191966	2.5 mm ²
	191967	4 mm ²
	191968	6 mm ²
	191969	10 mm ²
	192047	16 mm ²

IGNITION COIL TERMINALS

	HC-CARGO	Angled	Type
	190052		
	192222		w/ clip.
	192224	90°	Angled
	192225		Universal.

FOR POWER CONNECTORS

	HC-CARGO	Width	Cable size	Non return tag	Type
	191263	8 mm	2.5x4 mm ²	w/	Male, Flat Power connectors
	191983	8 mm	4x10 mm ²	w/	Male, Flat Power connectors
	191264	10.8 mm	10x16 mm ²	w/	Male, Flat Power connectors

SCREW TYPE

	HC-CARGO	Width	Angled	ID	Non return tag	Type
	191016	6.3 mm	45 °C	4.2 mm	w/o	Male, Flat
	192576	6.3 mm	45 °C	4.2 mm	w/o	Male, Flat
	190283	6.3 mm	45 °C	5.2 mm	w/o	Male, Flat
	191047	6.3 mm	90 °C	5.3 mm	w/o	Male, Flat
	191791	6.3 mm	45 °C	6.3 mm	w/o	Male, Flat
	192242	6.3 mm	45 °C	8.4 mm	w/o	Male, Flat
	191044	6.3-8 mm	180 °C	5.3 mm	w/o	Male, Flat Power connectors
	191048	9.5 mm	180 °C	5.3 mm	w/o	Male, Flat

TOOLS

CRIMPING

FOR INSULATED TERMINALS

210121 Crimping Tools Servicing: Insulated crimp terminals - Visit www.hc-cargo.com for further information
w/ cable cutter.



Dim.: 0.25-6 mm²

210638 Crimping Tools Servicing: Insulated crimp terminals - Visit www.hc-cargo.com for further information



Dim.: 0.5-6 mm²

Type: Insulated

FOR NON-INSULATED TERMINALS
210639 Crimping Tools

Servicing: Uninsulated Crimp Terminals

 Dim.: 0.5-6 mm²
210689 Crimping Tools

Servicing: Non insulated crimp terminals, suitable for A terminals

 Dim.: 0.25-6 mm²
210696 Crimping Tools

Servicing: Uninsulated Crimp Terminals

 Dim.: 1.5-10 mm²

Type: ABS

210760 Crimping Tools

 Servicing: Suitable for shrink copper tube terminals - Visit www.hc-cargo.com for further information

 Dim.: 10-95 mm²
 Length: 580 mm

210937 Crimping Tools

w/ cable cutter.











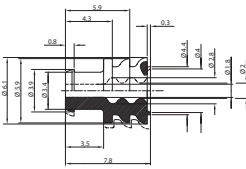

 Dim.: 1.5-6 mm²
210938 Crimping Tools

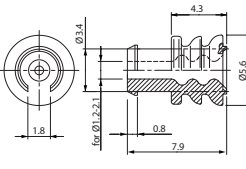
 Servicing: For cord end terminals - Visit www.hc-cargo.com for further information

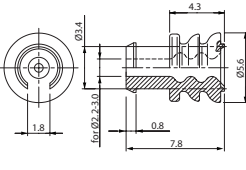
 Dim.: 0.5-6 mm²
210939 Crimping Tools

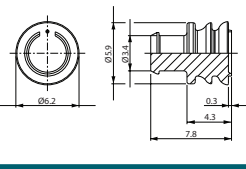
 Servicing: For cord end terminals - Visit www.hc-cargo.com for further information

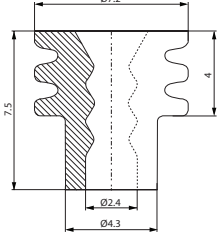
 Dim.: 6-16 mm²

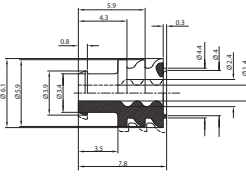
EL. SPECIFICATIONS	DIMENSIONS	ADDITIONAL SPECIFICATIONS
210973 Crimping Tools Servicing: Universal crimp tool for solid terminals, DEUTSCH etc		
	Dim.: 0.5-2 mm ²	
SINGLE WIRE SEAL NON INSULATED		
192091 Superseal Wire Seal		
<i>For Super Seal housing.</i>		
 	Cable dia.: 1.5-2.5 mm ID: 1.8/2 mm OD: 6.1 mm Length: 7.8 mm	Colour: Red Material: Silicone rubber
192177 Wire Seal Servicing: HC-CARGO 171788		
<i>For Junior-Power-Timer.</i>		
 	Cable dia.: 1.2-2.1 mm ID: 1.8 mm OD: 5.6 mm Length: 7.9 mm	Colour: Light blue Material: Silicone rubber
192178 Wire Seal		
<i>For Junior-Power-Timer.</i>		
 	Cable dia.: 1.5-2 mm ID: 1.8 mm OD: 5.6 mm Length: 7.8 mm	Colour: White Material: Silicone rubber
192179 JPT Blanking Plug		
<i>For Junior-Power-Timer housing.</i>		
 	Cable dia.: 1.5-2 mm ID: 3.4 mm OD: 6.1 mm Length: 7.8 mm	Colour: Transparent Material: Silicone rubber
192375 Single Wire Seal Servicing: HC-CARGO 192374, 192373		
<i>For metripack terminals.</i>		
 	Cable dia.: 1-2.5 mm ID: 2.4 mm OD: 7.2 mm Length: 7.5 mm	Colour: Green Material: Silicone rubber
192587 Single Wire Seal		
<i>For Super Seal housing.</i>		
 	Cable dia.: 0.75-1.5 mm ID: 1.4-2.4 mm OD: 6.1 mm Length: 7.8 mm	Colour: Yellow Material: Silicone rubber

192647 Rubber Silicone Seal

For fuse holder. Hole size: 8.2 mm.

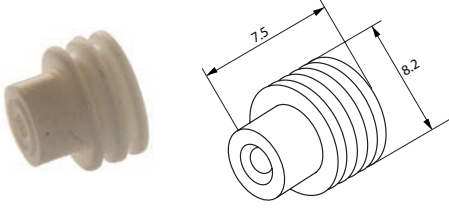
 Cable dia.: 2-3 mm
 ID: 1.9-3 mm
 OD: 8.2 mm
 Length: 7.5 mm

 Colour: White
 Material: Silicone rubber

192859 Blanking Plug

For Super Seal housing.

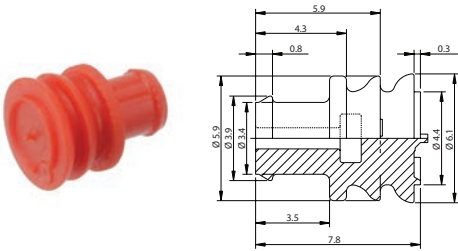
 OD: 6.1 mm
 Length: 7.8 mm

 Colour: Red
 Material: Silicone rubber

TERMINAL COVER
NON INSULATED
192808 Terminal Cover

 Terminal 1: 12 mm
 Terminal 2: 25.4 mm
 Cable dia.: 7.62 mm
 ID: 12.7 mm
 OD: 14 mm
 Height: 17.8 mm

 Colour: Black
 Material: PVC

192809 Terminal Cover

 Terminal 1: 14 mm
 Terminal 2: 25.4 mm
 Cable dia.: 7.62 mm
 ID: 12.7 mm
 OD: 14 mm
 Height: 19 mm

 Colour: Black
 Material: PVC

192810 Terminal Cover

 Terminal 1: 18 mm
 Terminal 2: 25.4 mm
 Cable dia.: 7.62 mm
 ID: 12.7 mm
 OD: 18 mm
 Height: 22.1 mm

 Colour: Black
 Material: PVC

192811 Terminal Cover







 Terminal 1: 20 mm
 Terminal 2: 33.5 mm
 Cable dia.: 12.7 mm
 ID: 17.8 mm
 OD: 20 mm
 Height: 24.1 mm

 Colour: Black
 Material: PVC

192812 Terminal Cover

 Terminal 1: 24 mm
 Terminal 2: 41.2 mm
 Cable dia.: 12.7 mm
 ID: 17.8 mm
 OD: 24 mm
 Height: 28.7 mm

 Colour: Black
 Material: PVC

EL. SPECIFICATIONS	DIMENSIONS	ADDITIONAL SPECIFICATIONS
192813 Terminal Cover 	Terminal 1: 32 mm Terminal 2: 44.5 mm Cable dia.: 17.8 mm ID: 22.9 mm OD: 32 mm Height: 38.1 mm	Colour: Black Material: PVC
192828 Terminal Cover 	Terminal 1: 12 mm Terminal 2: 25.4 mm Cable dia.: 7.62 mm ID: 12.7 mm OD: 14 mm Height: 17.8 mm	Colour: Red Material: PVC
192829 Terminal Cover 	Terminal 1: 14 mm Terminal 2: 25.4 mm Cable dia.: 7.62 mm ID: 12.7 mm OD: 14 mm Height: 19.1 mm	Colour: Red Material: PVC
192830 Terminal Cover 	Terminal 1: 18 mm Terminal 2: 25.4 mm Cable dia.: 7.62 mm ID: 12.7 mm OD: 18 mm Height: 22.1 mm	Colour: Red Material: PVC
192831 Terminal Cover 	Terminal 1: 20 mm Terminal 2: 33.5 mm Cable dia.: 12.7 mm ID: 17.8 mm OD: 20 mm Height: 24.1 mm	Colour: Red Material: PVC
192832 Terminal Cover 	Terminal 1: 24 mm Terminal 2: 41.2 mm Cable dia.: 12.7 mm ID: 17.8 mm OD: 24 mm Height: 28.7 mm	Colour: Red Material: PVC
192833 Terminal Cover 	Terminal 1: 32 mm Terminal 2: 44.5 mm Cable dia.: 17.8 mm ID: 22.9 mm OD: 32 mm Height: 38.1 mm	Colour: Red Material: PVC

INSULATORS

FEMALE HOLDERS

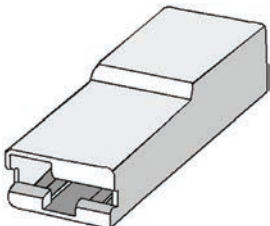
191007 Insulator 	Servicing: HC-CARGO 191008, 191064	Colour: White Male/female: Female
--	------------------------------------	--------------------------------------

191081 Insulator

Terminal: HC-CARGO 191079.

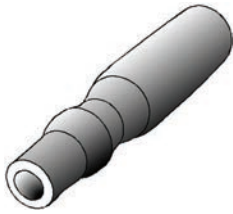
 Colour: Transparent
 Male/female: Female

191127 Insulator

Terminals: HC-CARGO 190252 or 191029.

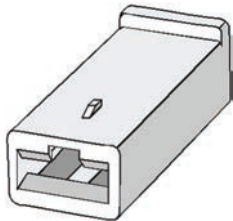
 Colour: White
 Male/female: Female

191227 Insulator

Terminal: HC-CARGO 192381.

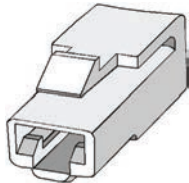
 Type: Japanese
 Colour: White
 Male/female: Female

191751 Insulator

Terminals: HC-CARGO 191246 or 191247.

 Colour: Black
 Male/female: Female

191937 Insulator

Terminal: HC-CARGO 191069.

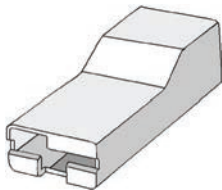
 Colour: White
 Male/female: Female

192442 Insulator

Terminal: HC-CARGO 192443.

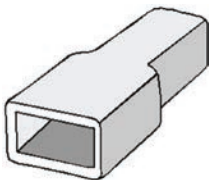
 Colour: White
 Male/female: Female

MALE HOLDERS
191080 Insulator

Terminal: HC-CARGO 191078.

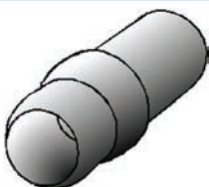
 Colour: Transparent
 Male/female: Male

191126 Insulator

Terminals: HC-CARGO 190270 or 191028.

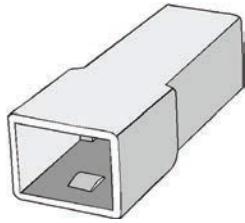

Colour: White
Male/female: Male

191226 Insulator

Servicing: 047200-6370, 047200-8441

Terminal: HC-CARGO 192380.

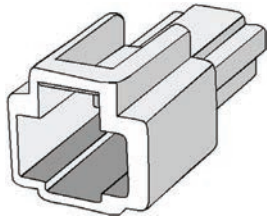

Type: Japanese
Colour: White
Male/female: Male

191650 Insulator

Terminal: HC-CARGO 191415.



Colour: Black
Male/female: Male

192002 Insulator

Terminal: HC-CARGO 192001.

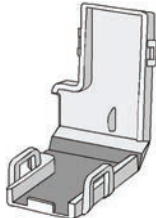

Type: Flag
Colour: White
Male/female: Male

MULTIPLE CONNECTORS

HOLDERS

2 POLE

190260 Connector

Terminal: HC-CARGO 190270, 191028.

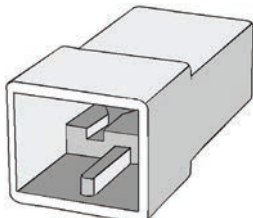

Colour: White
No./poles: 2
Plug: Male

190261 Connector

Terminal: HC-CARGO 190252, 191029. Rubber Boot: HC-CARGO 193010.

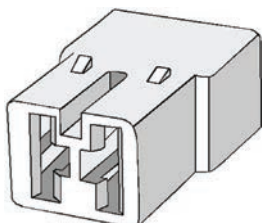

Colour: White
No./poles: 2
Plug: Female

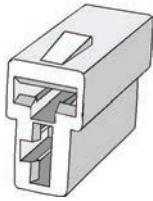
190272 Connector
Terminal: HC-CARGO 190252, 191029.

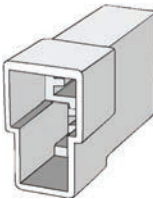
 Type/terminal: T-type
 Colour: White
 No./poles: 2
 Plug: Female

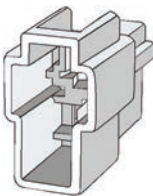
190843 Connector
Terminal: HC-CARGO 190270, 191028.

 Type/terminal: T-type
 Colour: White
 No./poles: 2
 Plug: Male

191158 Connector
Terminal: HC-CARGO 192380.

 Type/terminal: Japanese type
 Colour: White
 No./poles: 2
 Plug: Male

191159 Connector
Terminal: HC-CARGO 192381.

 Type/terminal: Japanese type
 Colour: Black
 No./poles: 2
 Plug: Female

191808 Connector

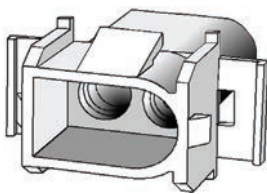
Servicing: Car Heaters

Terminal: HC-CARGO 191563.

 Colour: White
 No./poles: 2
 Plug: Male

191809 Connector

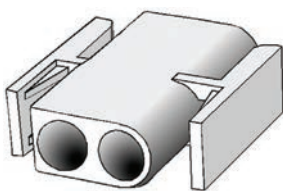
Servicing: Car Heaters

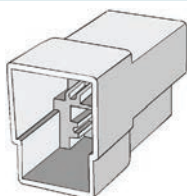
Terminal: HC-CARGO 191564.

 Colour: White
 No./poles: 2
 Plug: Female

3 POLE
190262 Connector
Terminal: HC-CARGO 190270, 191028.

 Colour: White
 No./poles: 3
 Plug: Male

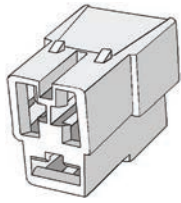
190263 Connector

Terminal: HC-CARGO 190252, 191029.



Colour: White
No./poles: 3
Plug: Female

191224 Connector

Terminal: HC-CARGO 192380.

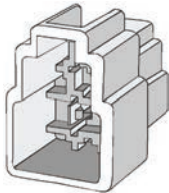

Type/terminal: Japanese type
Colour: White
No./poles: 3
Plug: Male

191225 Connector

Terminal: HC-CARGO 192381.

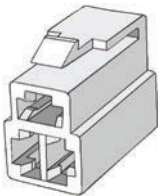

Type/terminal: Japanese type
Colour: White
No./poles: 3
Plug: Female

191810 Connector

Servicing: Car Heaters

Terminal: HC-CARGO 191563.

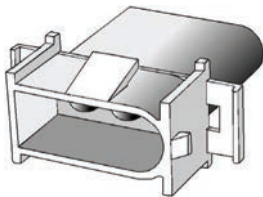

Colour: White
No./poles: 3
Plug: Male

191811 Connector

Servicing: Car Heaters

Terminal: HC-CARGO 191564.

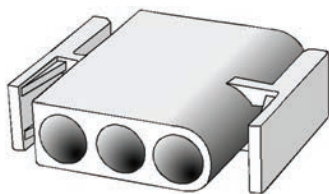

Colour: White
No./poles: 3
Plug: Female

191918 Connector

Terminal: HC-CARGO 191916.

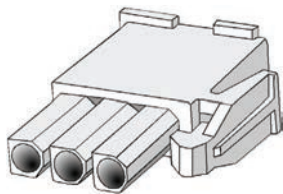

Colour: White
No./poles: 3
Plug: Female

4 POLE

190264 Connector

Terminal: HC-CARGO 190270, 191028.

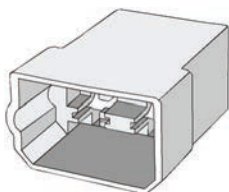

Colour: White
Material: Nylon 6.6 UL94-V2
No./poles: 4
Plug: Male

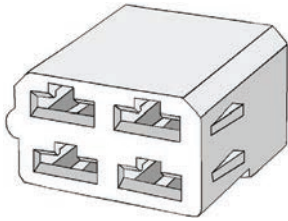
190265 Connector
Terminal: HC-CARGO 190252, 191029.

 Colour: White
 Material: Nylon 6.6 UL94-V2
 No./poles: 4
 Plug: Female

191070 Connector
Terminal: HC-CARGO 191074.

 Colour: White
 No./poles: 4
 Plug: Male

191071 Connector
Terminal: HC-CARGO 191075.

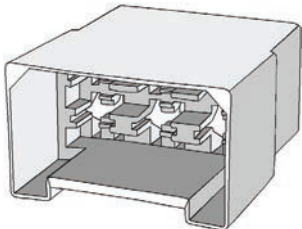
 Colour: White
 No./poles: 4
 Plug: Female

6 POLE
190266 Connector
Terminal: HC-CARGO 190270, 191028.

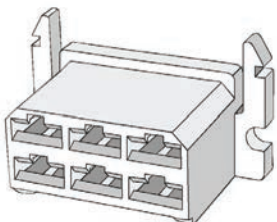
 Colour: White
 No./poles: 6
 Plug: Male

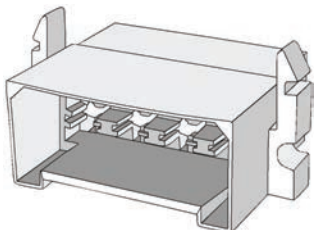
190267 Connector
Terminal: HC-CARGO 190252, 191029.

 Colour: White
 No./poles: 6
 Plug: Female

8 POLE
190268 Connector
Terminal: HC-CARGO 190270, 191028.

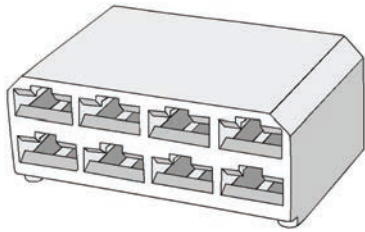
 Colour: White
 No./poles: 8
 Plug: Male

190269 Connector

Terminal: HC-CARGO 190252, 191029.



Colour: White
No./poles: 8
Plug: Female

9 POLE

191561 Connector

Terminal: HC-CARGO 191563.

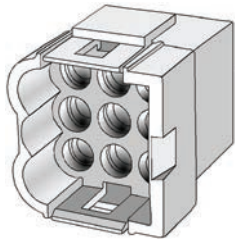

Colour: White
No./poles: 9
Plug: Male

191562 Connector

Terminal: HC-CARGO 191564.

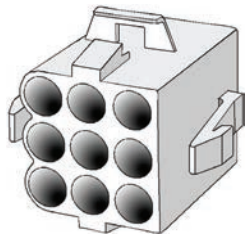

Colour: White
No./poles: 9
Plug: Female

12 POLE

192488 Connector

Terminal: HC-CARGO 191092.

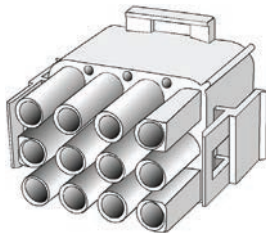

Colour: White
No./poles: 12
Plug: Male

192501 Connector

Terminal: HC-CARGO 191091.

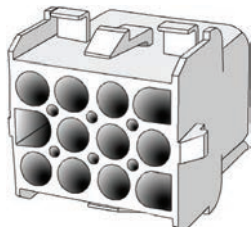

Colour: White
No./poles: 12
Plug: Female

ACCESSORIES

193010 Rubber Boot

Servicing: HC-CARGO 190261



Material: EPDM rubber

DEUTSCH-CONNECTOR DT

2 POLE

192457 DT Connector

Servicing: HC-CARGO 192657

DT06-2S. Terminal: HC-CARGO 192478. Secondary lock: HC-CARGO 192467. Rubber Boot: HC-CARGO 193092.

 Type/terminal: DT
 Colour: Grey
 No./poles: 2
 Plug: Female

192458 DT Connector

Servicing: HC-CARGO 192658

DT04-2P. Terminal: HC-CARGO 192477. Secondary lock: HC-CARGO 192468. Rubber Boot: HC-CARGO 193091.

 Type/terminal: DT
 Colour: Grey
 No./poles: 2
 Plug: Male

ACCESSORIES

192467 Secondary Lock

W 2S.

 Type/terminal: DT
 No./poles: 2
 Plug: Female

192468 Secondary Lock

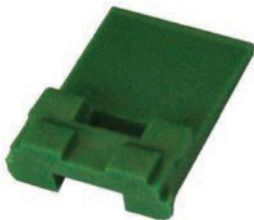
W 2P.

 Type/terminal: DT
 No./poles: 2
 Plug: Male

193091 Rubber Boot 2p DT

Servicing: HC-CARGO 192458

 Colour: Grey
 No./poles: 2

193092 Rubber Boot 2s DT

Servicing: HC-CARGO 192457

 Colour: Grey
 No./poles: 2

3 POLE

192459 DT Connector

DT06-3S. Terminal: HC-CARGO 192478. Secondary lock: HC-CARGO 192469. Rubber Boot: HC-CARGO 193094.



Type/terminal: DT
Colour: Grey
No./poles: 3
Plug: Female

192460 DT Connector

DT04-3P. Terminal: HC-CARGO 192477. Secondary lock: HC-CARGO 192470. Rubber Boot: HC-CARGO 193093.



Type/terminal: DT
Colour: Grey
No./poles: 3
Plug: Male

ACCESSORIES

192469 Secondary Lock

Servicing: HC-CARGO 192459

W 3S.



Type/terminal: DT
No./poles: 3
Plug: Female

192470 Secondary Lock

W 3P.



Type/terminal: DT
No./poles: 3
Plug: Male

193093 Rubber Boot 3p DT

Servicing: HC-CARGO 192460



Colour: Grey
No./poles: 3

193094 Rubber Boot 3s DT

Servicing: HC-CARGO 192459



Colour: Grey
No./poles: 3

4 POLE

192461 DT Connector

DT06-4S. Terminal: HC-CARGO 192478. Secondary lock: HC-CARGO 192471. Rubber Boot: HC-CARGO 193096.



Type/terminal: DT
Colour: Grey
No./poles: 4
Plug: Female

192462 DT Connector
DT04-4P. Terminal: HC-CARGO 192477. Secondary lock: HC-CARGO 192472. Rubber Boot: HC-CARGO 193095.

 Type/terminal: DT
 Colour: Grey
 No./poles: 4
 Plug: Male

ACCESSORIES
192471 Secondary Lock

Servicing: HC-CARGO 192461

W 4S.

 Type/terminal: DT
 No./poles: 4
 Plug: Female

192472 Secondary Lock

Servicing: HC-CARGO 192462

W 4P.

 Type/terminal: DT
 No./poles: 4
 Plug: Male

193095 Rubber Boot 4p DT

Servicing: HC-CARGO 192462

 Colour: Grey
 No./poles: 4

193096 Rubber Boot 4s DT

Servicing: HC-CARGO 192461









 Colour: Grey
 No./poles: 4

6 POLE
192463 DT Connector
DT06-6S. Terminal: HC-CARGO 192478. Secondary lock: HC-CARGO 192473. Rubber Boot: HC-CARGO 193098.

 Type/terminal: DT
 Colour: Grey
 No./poles: 6
 Plug: Female

192464 DT Connector
DT04-6P. Terminal: HC-CARGO 192477. Secondary lock: HC-CARGO 192474. Rubber Boot: HC-CARGO 193097.

 Type/terminal: DT
 Colour: Grey
 No./poles: 6
 Plug: Male

ACCESSORIES			
192473 Secondary Lock			
W 6S.			
			Type/terminal: DT No./poles: 6 Plug: Female
192474 Secondary Lock			
W 6P.			
			Type/terminal: DT No./poles: 6 Plug: Male
193097 Rubber Boot 6p DT		Servicing: HC-CARGO 192464	
			Colour: Grey No./poles: 6
193098 Rubber Boot 6s DT		Servicing: HC-CARGO 192463	
			Colour: Grey No./poles: 6
8 POLE			
192465 DT Connector			
DT06-8S. Terminal: HC-CARGO 192478. Secondary lock: HC-CARGO 192475. Rubber Boot: HC-CARGO 193100.			
			Type/terminal: DT Colour: Grey No./poles: 8 Plug: Female
192466 DT Connector			
DT04-8P. Terminal: HC-CARGO 192477. Secondary lock: HC-CARGO 192476. Rubber Boot: HC-CARGO 193099.			
			Type/terminal: DT Colour: Grey No./poles: 8 Plug: Male
ACCESSORIES			
192475 Secondary Lock		Servicing: HC-CARGO 192465	
W 8S.			
			Type/terminal: DT No./poles: 8 Plug: Female

192476 Secondary Lock

Servicing: HC-CARGO 192466

W 8P.

 Type/terminal: DT
 No./poles: 8
 Plug: Male

193099 Rubber Boot 8p DT

Servicing: HC-CARGO 192466

 Colour: Grey
 No./poles: 8

193100 Rubber Boot 8s DT

Servicing: HC-CARGO 192465

 Colour: Grey
 No./poles: 8

12 POLE
192450 DT Connector

DT06-12S. Terminal: HC-CARGO 192478. Secondary lock: HC-CARGO 192452. Rubber Boot: HC-CARGO 193102.

 Type/terminal: DT
 Colour: Grey
 No./poles: 12
 Plug: Female

192451 DT Connector

DT04-12P. Terminal: HC-CARGO 192477. Secondary lock: HC-CARGO 192453. Rubber Boot: HC-CARGO 193101.

 Type/terminal: DT
 Colour: Grey
 No./poles: 12
 Plug: Male

ACCESSORIES
192452 Secondary Lock

Servicing: HC-CARGO 192450

W 12S.

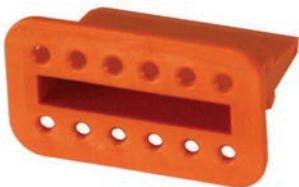







 Type/terminal: DT
 No./poles: 12
 Plug: Female







192453 Secondary Lock







Servicing: HC-CARGO 192451

W 12P.

 Type/terminal: DT
 No./poles: 12
 Plug: Male

EL. SPECIFICATIONS	DIMENSIONS	ADDITIONAL SPECIFICATIONS
193101 Rubber Boot 12p DT Servicing: HC-CARGO 192451		
		Colour: Grey No./poles: 12
193102 Rubber Boot 12s DT Servicing: HC-CARGO 192450		
		Colour: Grey No./poles: 12
ACCESSORIES		
192787 Sealing Plug Servicing: DT		
		
DEUTSCH-CONNECTOR DTM		
2 POLE		
192595 DTM Connector		
<i>DTM06-2S. Terminal: HC-CARGO 192620. Secondary lock: HC-CARGO 192607. Rubber Boot: HC-CARGO 193104.</i>		
		Type/terminal: DTM Colour: Grey No./poles: 2 Plug: Female
192596 DTM Connector		
<i>DTM04-2P. Terminal: HC-CARGO 192619. Secondary lock: HC-CARGO 192608. Rubber Boot: HC-CARGO 193103.</i>		
		Type/terminal: DTM Colour: Grey No./poles: 2 Plug: Male
ACCESSORIES		
192607 Secondary Lock Servicing: HC-CARGO 192595		
WM 2S.		
		Type/terminal: DTM No./poles: 2 Plug: Female
192608 Secondary Lock Servicing: HC-CARGO 192596		
WM 2P.		
		Type/terminal: DTM No./poles: 2 Plug: Male

	EL. SPECIFICATIONS	DIMENSIONS	ADDITIONAL SPECIFICATIONS
193103 Rubber Boot 2p DTM	Servicing: HC-CARGO 192596		Colour: Grey No./poles: 2
			
193104 Rubber Boot 2s DTM	Servicing: HC-CARGO 192595		Colour: Grey No./poles: 2
			
3 POLE			
192597 DTM Connector			
<i>DTM06-3S. Terminal: HC-CARGO 192620. Secondary lock: HC-CARGO 192609. Rubber Boot: HC-CARGO 193106.</i>			
			Type/terminal: DTM Colour: Grey No./poles: 3 Plug: Female
192598 DTM Connector			
<i>DTM04-3P. Terminal: HC-CARGO 192619. Secondary lock: HC-CARGO 192610. Rubber Boot: HC-CARGO 193105.</i>			
			Type/terminal: DTM Colour: Grey No./poles: 3 Plug: Male
ACCESSORIES			
192609 Multiple Connector	Servicing: HC-CARGO 192597		
<i>WM 3S.</i>			
			Type/terminal: DTM No./poles: 3 Plug: Female
192610 Multiple Connector	Servicing: HC-CARGO 192598		
<i>WM 3P.</i>			
			Type/terminal: DTM No./poles: 3 Plug: Male
193105 Rubber Boot 3p DTM	Servicing: HC-CARGO 192598		Colour: Grey No./poles: 3
			

EL. SPECIFICATIONS	DIMENSIONS	ADDITIONAL SPECIFICATIONS
193106 Rubber Boot 3s DTM Servicing: HC-CARGO 192597		
		Colour: Grey No./poles: 3
4 POLE		
192599 DTM Connector		
<i>DTM06-4S. Terminal: HC-CARGO 192620. Secondary lock: HC-CARGO 192611. Rubber Boot: HC-CARGO 193108.</i>		
		Type/terminal: DTM Colour: Grey No./poles: 4 Plug: Female
192600 DTM Connector		
<i>DTM04-4P. Terminal: HC-CARGO 192619. Secondary lock: HC-CARGO 192612. Rubber Boot: HC-CARGO 193107.</i>		
		Type/terminal: DTM Colour: Grey No./poles: 4 Plug: Male
ACCESSORIES		
192611 Multiple Connector Servicing: HC-CARGO 192599		
<i>WM 4S.</i>		
		Type/terminal: DTM No./poles: 4 Plug: Female
192612 Multiple Connector Servicing: HC-CARGO 192600		
<i>WM 4P.</i>		
		Type/terminal: DTM No./poles: 4 Plug: Male
193107 Rubber Boot 4p DTM Servicing: HC-CARGO 192600		
		Colour: Grey No./poles: 4
193108 Rubber Boot 4s DTM Servicing: HC-CARGO 192599		
		Colour: Grey No./poles: 4

6 POLE

192601 DTM Connector

DTM06-6S. Terminal: HC-CARGO 192620. Secondary lock: HC-CARGO 192613. Rubber Boot: HC-CARGO 193110.



Type/terminal: DTM
Colour: Grey
No./poles: 6
Plug: Female

192602 DTM Connector

DTM04-6P. Terminal: HC-CARGO 192619. Secondary lock: HC-CARGO 192614. Rubber Boot: HC-CARGO 193109.



Type/terminal: DTM
Colour: Grey
No./poles: 6
Plug: Male

ACCESSORIES

192613 Multiple Connector

Servicing: HC-CARGO 192601

WM 6S.



Type/terminal: DTM
No./poles: 6
Plug: Female

192614 Multiple Connector

Servicing: HC-CARGO 192602

WM 6P.



Type/terminal: DTM
No./poles: 6
Plug: Male

193109 Rubber Boot 6p DTM

Servicing: HC-CARGO 192602



Colour: Grey
No./poles: 6

193110 Rubber Boot 6s DTM

Servicing: HC-CARGO 192601



Colour: Grey
No./poles: 6

8 POLE

192603 DTM Connector

DTM06-8S. Terminal: HC-CARGO 192620. Secondary lock: HC-CARGO 192615. Rubber Boot: HC-CARGO 193112.



Type/terminal: DTM
Colour: Grey
No./poles: 8
Plug: Female

192604 DTM Connector

DTM04-8P. Terminal: HC-CARGO 192619. Secondary lock: HC-CARGO 192616. Rubber Boot: HC-CARGO 193111.



Type/terminal: DTM
 Colour: Grey
 No./poles: 8
 Plug: Male

ACCESSORIES

192615 Multiple Connector

Servicing: HC-CARGO 192603

WM 8S.



Type/terminal: DTM
 No./poles: 8
 Plug: Female

192616 Multiple Connector

Servicing: HC-CARGO 192604

WM 8P.



Type/terminal: DTM
 No./poles: 8
 Plug: Male

193111 Rubber Boot 8p DTM

Servicing: HC-CARGO 192604



Colour: Grey
 No./poles: 8

193112 Rubber Boot 8s DTM

Servicing: HC-CARGO 192603



Colour: Grey
 No./poles: 8

12 POLE

192605 DTM Connector

DTM06-12P. Terminal: HC-CARGO 192620. Secondary lock: HC-CARGO 192617. Rubber Boot: HC-CARGO 193114.



Type/terminal: DTM
 Colour: Grey
 No./poles: 12
 Plug: Female

192606 DTM Connector

DTM04-12P. Terminal: HC-CARGO 192619. Secondary lock: HC-CARGO 192618. Rubber Boot: HC-CARGO 193113.

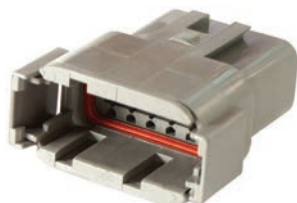

Type/terminal: DTM
 Colour: Grey
 No./poles: 12
 Plug: Male

ACCESSORIES
192617 Multiple Connector Servicing: HC-CARGO 192605

WM 12S.

 Type/terminal: DTM
 No./poles: 12
 Plug: Female

192618 Multiple Connector Servicing: HC-CARGO 192606

WM 12P.

 Type/terminal: DTM
 No./poles: 12
 Plug: Male

193113 Rubber Boot 12p DTM Servicing: HC-CARGO 192606

 Colour: Grey
 No./poles: 12

193114 Rubber Boot 12s DTM Servicing: HC-CARGO 192605

 Colour: Grey
 No./poles: 12

ACCESSORIES
192788 Sealing Plug Servicing: DTM

DEUTSCH-CONNECTOR DTP
2 POLE
193017 DTP Connector







DTP04-2P. Terminal: HC-CARGO 192621. Secondary lock: HC-CARGO 193021. Rubber Boot: HC-CARGO 193115.

 Type/terminal: DTP
 No./poles: 2
 Plug: Male

193018 DTP Connector

DTP06-2S. Terminal: HC-CARGO 192622. Secondary lock: HC-CARGO 193022. Rubber Boot: HC-CARGO 193116.

 Type/terminal: DTP
 No./poles: 2
 Plug: Female

ACCESSORIES		
193021 Secondary Lock Servicing: HC-CARGO 193017		
WP 2P.		
		Type/terminal: DTP No./poles: 2 Plug: Male
193022 Secondary Lock Servicing: HC-CARGO 193018		
WP 2S.		
		Type/terminal: DTP No./poles: 2 Plug: Female
193115 Rubber Boot 2p DTP Servicing: HC-CARGO 193017		
		Colour: Grey No./poles: 2
193116 Rubber Boot 2s DTP Servicing: HC-CARGO 193018		
		Colour: Grey No./poles: 2
4 POLE		
193019 DTP Connector		
<i>DTP04-4P. Terminal: HC-CARGO 192621. Secondary lock: HC-CARGO 193023. Rubber Boot: HC-CARGO 193117.</i>		
		Type/terminal: DTP No./poles: 4 Plug: Male
193020 DTP Connector		
<i>DTP06-4S. Terminal: HC-CARGO 192622. Secondary lock: HC-CARGO 193024. Rubber Boot: HC-CARGO 193118.</i>		
		Type/terminal: DTP No./poles: 4 Plug: Female
ACCESSORIES		
193023 Secondary Lock Servicing: HC-CARGO 193019		
WP 4P.		
		Type/terminal: DTP No./poles: 4 Plug: Male

193024 Secondary Lock

Servicing: HC-CARGO 193020

WP 4S.



Type/terminal: DTP
No./poles: 4
Plug: Female

193117 Rubber Boot 4p DTP

Servicing: HC-CARGO 193019



Colour: Grey
No./poles: 4

193118 Rubber Boot 4s DTP

Servicing: HC-CARGO 193020



Colour: Grey
No./poles: 4

DEUTSCH-CONNECTOR ACCESSORIES

192987 Mounting Bracket

Fits on DT, DTM, DTP and DTHD.



DEUTSCH-CONNECTOR HD

9 POLE

193042 HD Connector 9-pin Female

Servicing: HC-CARGO 193043

HD16-9-1939PE. Terminal: 9x HC-CARGO 192505.



Type/terminal: HD16-connector
No./poles: 9
Plug: Female

193043 HD Connector 9-pin Male

Servicing: HC-CARGO 193042

HD10-9-1939PE. Terminal: 9x HC-CARGO 192506.



Type/terminal: HD10-connector
No./poles: 9
Plug: Male

DEUTSCH-CONNECTOR HDP

9 POLE

193044 HDP Connector 9-pin Female

Servicing: HC-CARGO 193045

HDP26-24-95N. Terminal: 6x HC-CARGO 192621, 2x HC-CARGO 193233, 1x HC-CARGO 193234



Type/terminal: HDP26-connector
No./poles: 9
Plug: Female

193045 HDP Connector 9-pin Male

Servicing: HC-CARGO 193044

HDP24-24-9PN. Terminal: 6x HC-CARGO 192622, 2x HC-CARGO 193235, 1x HC-CARGO 193236



Type/terminal: HDP24-connector
No./poles: 9
Plug: Male

23 POLE

192651 HDP26 Connector

HDP26-24-23-PE. Terminals: 23x HC-CARGO 192505, 192477, 192622. Seal 23x HC-CARGO 192787.



Amp: 13

Type/terminal: HDP26-connector
No./poles: 23
Plug: Male

192652 HDP26 Connector

HDP24-24-23-SE. Terminals: 23x HC-CARGO 192506, 192478. Seal: 23x HC-CARGO 192787.



Amp: 13

Type/terminal: HDP26-connector
No./poles: 23
Plug: Female

31 POLE

192655 HDP26 Connector

HDP26-24-31-PE. Terminals: 31x HC-CARGO 192505, 192477. Seal: 31x HC-CARGO 192787.



Amp: 13

Type/terminal: HDP26-connector
No./poles: 31
Plug: Male

192656 HDP26 Connector

HDP24-24-31-SE. Terminals: 31x HC-CARGO 192506, 192478. Seal: 31x HC-CARGO 192787.



Amp: 13

Type/terminal: HDP26-connector
No./poles: 31
Plug: Female

ACCESSORIES

192683 Panel Nut

Servicing: HDP26-connectors. ID: UNF 1 11/16".

HC-CARGO 192650, -652, -654, 656.



SUPERSEAL

1 POLE

192077 Superseal Connector

Terminal: HC-CARGO 192089. Single wire seal: HC-CARGO 192587, 192091.



Type/terminal: Super Seal Connector
 Colour: Black
 No./poles: 1
 Plug: Male

192078 Superseal Connector

Terminal: HC-CARGO 192090. Single wire seal: HC-CARGO 192587, 192091.



Type/terminal: Super Seal Connector
 Colour: Black
 No./poles: 1
 Plug: Female

2 POLE

192079 Superseal Connector

Terminal: HC-CARGO 192089. Single wire seal: HC-CARGO 192587, 192091.



Type/terminal: Super Seal Connector
 Colour: Black
 No./poles: 2
 Plug: Male

192080 Superseal Connector

Terminal: HC-CARGO 192090. Single wire seal: HC-CARGO 192587, 192091.



Type/terminal: Super Seal Connector
 Colour: Black
 No./poles: 2
 Plug: Female

3 POLE

192081 Superseal Connector

Terminal: HC-CARGO 192089. Single wire seal: HC-CARGO 192587, 192091.



Type/terminal: Super Seal Connector
 Colour: Black
 No./poles: 3
 Plug: Male

192082 Superseal Connector

Terminal: HC-CARGO 192090. Single wire seal: HC-CARGO 192587, 192091.



Type/terminal: Super Seal Connector
 Colour: Black
 No./poles: 3
 Plug: Female

4 POLE

192083 Superseal Connector

Terminal: HC-CARGO 192089. Single wire seal: HC-CARGO 192587, 192091.



Type/terminal: Super Seal Connector
 Colour: Black
 No./poles: 4
 Plug: Male

192084 Superseal Connector

Terminal: HC-CARGO 192090. Single wire seal: HC-CARGO 192587, 192091.



Type/terminal: Super Seal Connector
 Colour: Black
 No./poles: 4
 Plug: Female

5 POLE

192085 Superseal Connector

Terminal: HC-CARGO 192089. Single wire seal: HC-CARGO 192587, 192091.



Type/terminal: Super Seal Connector
 Colour: Black
 No./poles: 5
 Plug: Male

192086 Superseal Connector

Terminal: HC-CARGO 192090. Single wire seal: HC-CARGO 192587, 192091.



Type/terminal: Super Seal Connector
 Colour: Black
 No./poles: 5
 Plug: Female

6 POLE

192087 Superseal Connector

Terminal: HC-CARGO 192089. Single wire seal: HC-CARGO 192587, 192091.



Type/terminal: Super Seal Connector
 Colour: Black
 No./poles: 6
 Plug: Male

192088 Superseal Connector

Terminal: HC-CARGO 192090. Single wire seal: HC-CARGO 192587, 192091.



Type/terminal: Super Seal Connector
 Colour: Black
 No./poles: 6
 Plug: Female

JUNIOR-TIMER-CONNECTOR

2 POLE

192146 Junior Timer Connector

Terminal: HC-CARGO 191551, 192155. Rubber boot: HC-CARGO 192150, 192151.

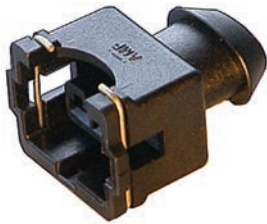

Type/terminal: Junior Timer
 Colour: Black
 No./poles: 2
 Plug: Female

192166 Junior Timer Connector

Terminal: HC-CARGO 192174.



Type/terminal: Junior Timer
 Colour: Black
 No./poles: 2
 Plug: Male

192884 Holder

Terminals: HC-CARGO 191551, 192155. Wire guzzle: HC-CARGO 192177, 192178. Rubber cap: HC-CARGO 192150, 192151.



Cable dia: 2.5 mm

Colour: Black
 No./poles: 2
 Plug: Female

192902 Connector

Plug 75. Terminal: HC-CARGO 192998.



Colour: Black
 No./poles: 2
 Plug: Male

7 POLE

192149 Junior Timer Connector

Terminal: HC-CARGO 191551, 192155. Rubber boot: HC-CARGO 192154.



Type/terminal: Junior Timer
 Colour: Black
 No./poles: 7
 Plug: Female

JUNIOR-POWER-TIMER-CONNECTOR

2 POLE

192147 Junior Power Timer Connector

Terminal: HC-CARGO 192175, 192176. Wire seal: HC-CARGO 192177, 192178. Rubber boot: HC-CARGO 192152.



Type/terminal: Junior Power Timer
Colour: Black
No./poles: 2
Plug: Female

192167 Junior Power Timer Connector

Terminal: HC-CARGO 192156, 192157. Wire seal: HC-CARGO 192177, 192178.

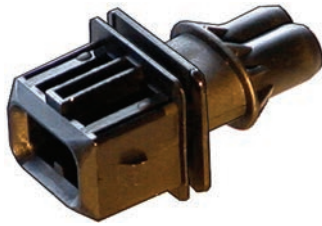

Type/terminal: Junior Power Timer
Colour: Black
No./poles: 2
Plug: Male

192502 Junior Power Timer Connector

Terminal: HC-CARGO 192503. Wire seal: HC-CARGO 192504. Rubber boot: HC-CARGO 192150, 192151.



Type/terminal: Junior Power Timer
Colour: Black
No./poles: 2
Plug: Male

193119 Junior Power Timer Connector

Servicing: HC-CARGO 171835, 171836

Terminal: Cargo 192175, 192176, 192177, 192178, 192179.



Type/terminal: Junior Power Timer
Colour: Black
No./poles: 2
Plug: Female

3 POLE

192148 Junior Power Timer Connector

Servicing: HC-CARGO 193241

Terminal: HC-CARGO 192175, 192176. Wire seal: HC-CARGO 192177, 192178. Rubber boot: HC-CARGO 192153.



Type/terminal: Junior Power Timer
Colour: Black
No./poles: 3
Plug: Female

193241 Junior Power Timer Connector

Servicing: HC-CARGO 192148



Type/terminal: Junior Power Timer
Colour: Black
No./poles: 3
Plug: Male

4 POLE
192171 Junior Power Timer Connector
Terminal: HC-CARGO 192175, 192176. Wire seal: HC-CARGO 192177, 192178.

 Type/terminal: Junior Power Timer
 Colour: Black
 No./poles: 4
 Plug: Female

5 POLE
192172 Junior Power Timer Connector
Terminal: HC-CARGO 192175, 192176. Wire seal: HC-CARGO 192177, 192178.

 Type/terminal: Junior Power Timer
 Colour: Black
 No./poles: 5
 Plug: Female

6 POLE
192173 Junior Power Timer Connector
Terminal: HC-CARGO 192175, 192176. Wire seal: HC-CARGO 192177, 192178.

 Type/terminal: Junior Power Timer
 Colour: Black
 No./poles: 6
 Plug: Female

JUNIOR-POWER-TIMER ACCESSORIES
192150 Rubber Boot
For 4 pole Junior-Timer connector.

Length: 57 mm

192151 Rubber Boot
For 2 pole Junior-Timer connector.

Length: 37 mm

192152 Rubber Boot
For 2 pole junior-timer connector. Angled.

Length: 48 mm

192153 Rubber Boot

For 3 pole junior-powertimer connector.



Length: 57 mm

192154 Rubber Boot

For 7 pole junior-timer connector.



Length: 57 mm

CONNECTORS

TOOLS

EXTRACTION

210643 Ejection Tool

Servicing: For round lug w/ locking tab. For 6.5 mm mounting and dismantability bushing. - Visit www.hc-cargo.com for further information

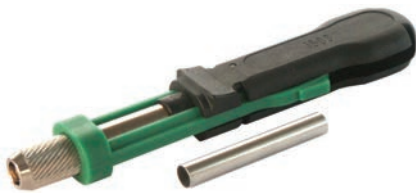

210661 Ejection Tool

For round lug w/ locking tab. For 3.3 mm dismantability bushing.



210667 Ejection Tool

For flat terminals w/ locking tongues for 3.3 mm receptacle.



210851 Ejection Tool

Servicing: Round terminal., Mini universal - Visit www.hc-cargo.com for further information



210918 Ejection Tool

For Micro Timer II terminals.



210919 Ejection Tool

To 2.8 mm standard lugs, 6.3 mm standard lugs and Junior Timer lugs.



210921 Ejection Tool

For junior power timer (male and female lugs) and the standard power timer (male and female lugs).



211030 Ejection Tool

For 1.5 mm Super Seal connector lugs.



SETS

210672 Kabelex Tool Set

For round plug connector in the plastic box. Contains 10 pcs: 1 pcs. of HC-CARGO 210661, 1 pcs. of HC-CARGO 210662, 1 pcs. of HC-CARGO 210643, 2 pcs. of HC-CARGO 210664, 2 pcs. of HC-CARGO 210665, 2 pcs. of HC-CARGO 210644, 1 pcs. of HC-CARGO 210645.



210675 Kabelex Tool Set

For flat plug connector in the plastic box. includes 5 pieces: 1x HC-CARGO 210667, 1x HC-CARGO 210668, 1x HC-CARGO 210669, 1x HC-CARGO 210670, 1x HC-CARGO 210671.



SPARE BLADES

211017 Spare Blade

Servicing: HC-CARGO 210921 old model



211018 Spare Blade

Servicing: HC-CARGO 210921 old model



FOR DEUTSCH-CONNECTOR TERMINALS

211051 Contact Removal Tool

For DEUTSCH 0.2-0.5 mm². DEUTSCH 0411-240-2005.



211052 Contact Removal Tool

For DEUTSCH 1-2 mm². DEUTSCH 0411-240-1605.



211053 Contact Removal Tool

Deutsch. (2-3 mm²).



211120 Contact Removal Tool

Servicing: Deutsch DTM, Deutsch 13760 DT RT1



211127 Contact Removal Tool

For DEUTSCH 13 mm².



3 POLE

132804 Plug Kit

Servicing: ACR

HC-CARGO 190725 - 1. HC-CARGO 190726 - 2. HC-CARGO 190733 - 1.

 Type/terminal: Flat
 Colour: Black
 No./poles: 3
 Plug: Female

190259 Connector

Terminal: HC-CARGO 190252.

 Colour: Black
 No./poles: 3
 Plug: Female

192871 Connector

Terminal: HC-CARGO 192411.

 Colour: Black
 No./poles: 3
 Plug: Female

4 POLE

190762 Connector

Terminal: HC-CARGO 190252.

 Colour: Black
 No./poles: 4
 Plug: Female

POWER

1 POLE

191405 Power Connector

Terminals: HC-CARGO 191263, -264, -983.

Amp: 150

 No./poles: 1
 Plug: Male

191406 Power Connector

Terminals: HC-CARGO 191260, -261, -262.



Amp: 150

 No./poles: 1
 Plug: Female

2 POLE

191407 Power Connector

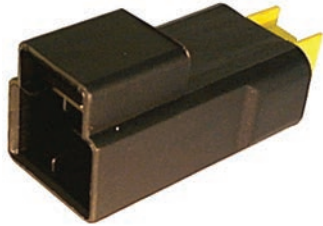
Terminals: HC-CARGO 191263, -264, -983.



Amp: 150

No./poles: 2
Plug: Male

191408 Power Connector

Terminals: HC-CARGO 191260, -261, -262.

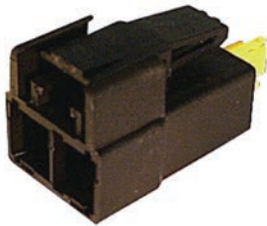

Amp: 150

No./poles: 2
Plug: Female

4 POLE

181545 Connector

Servicing: HC-CARGO 181476

DIN 72585.



Amp: 30

Colour: Black
No./poles: 4
Plug: Male

CABLES

FLAT TONGUE

190043 Butt Splices



Width: 6.3 mm

Terminal type: Flat
Out: 1
Plugs in: 1

190776 Butt Splices

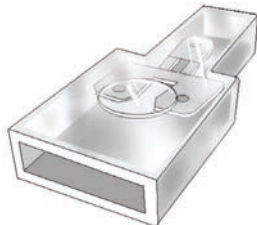

Width: 6.3 mm

Terminal type: Flat
Out: 2
Plugs in: 1

190956 Butt Splices

Strip of 12.



Width: 6.3 mm

Terminal type: Flat

192648 Butt Splices

Width: 6.3 mm

 Terminal type: Flat
 Out: 3
 Plugs in: 1

WIRE NUTS
RED
191076 Cable Connector

 Dim.: 1-2 mm²
 Dim 2: 0.5-1 mm²
191077 Cable Connector







 Dim.: 0.5-1 mm²
191485 Cable Connector

 Dim.: 0.5-1 mm²
BLUE
190875 Cable Connector

 Dim.: 1.5-2.5 mm²
190971 Cable Connector

 Dim.: 1.5-2.5 mm²
BROWN
191484 Cable Connector

 Dim.: 2.5-4 mm²
 Dim 2: 0.75-1.5 mm²

RED TRANSPARENT			
191498 Cable Connector		Servicing: HC-CARGO 190895, 191485	
6.3 mm.			
		Dim.: 0.5-1.5 mm ²	Terminal type: Male
TRANSPARENT			
190876 Cable Connector		Servicing: HC-CARGO 190875, 191485	
6.3 mm.			
		Dim.: 1.5-2.5 mm ²	Terminal type: Male
SCREW TERMINAL			
190195 Cable Connector			
Number of 12. Max 24 A.			
		Dim.: 2.5 mm ²	Terminal type: Screw
190196 Cable Connector			
Number of 12. Max 32 A.			
		Dim.: 4-6 mm ²	Terminal type: Screw
190197 Cable Connector			
Number of 12. Max 76 A.			
		Dim.: 16 mm ²	Terminal type: Screw
190911 Cable Connector			
Number of 12. Max 41 A.			
		Dim.: 10 mm ²	Terminal type: Screw
191756 Butt Splices		Servicing: HC-CARGO 191755	
8x6 terminalblock. 25 A. Terminal width: 6.3 mm			
		Dist. mount. holes: 99 mm	Terminal type: Flat Material: Polycarbonate Out: 8 Plugs in: 8

191771 Butt Splices

1x8. For HC-CARGO 191755. 20 A.

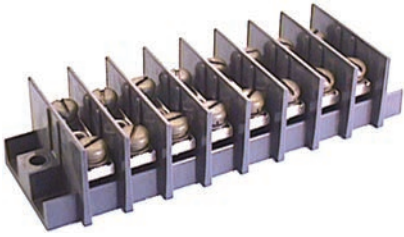
 Dist. mount. holes:
99 mm

 Terminal type: Screw
Material: Polycarbonate
Out: 8
Plugs in: 8

193011 Terminal Block

25 A. Terminal width: 6.3 mm

 Dist. mount. holes:
77.3 mm

 Terminal type: Flat
Material: Polycarbonate
Out: 6
Plugs in: 6

BATTERY TERMINALS
BRASS CASTING
25-35 MM²
192368 Battery Terminal

 Length: 46 mm
Cable size/max: 35 mm²
Cable size/min: 25 mm²
Polarity: Positive

Material: Moulded brass

192369 Battery Terminal

 Length: 46 mm
Cable size/max: 35 mm²
Cable size/min: 25 mm²
Polarity: Negative

Material: Moulded brass

W/ 10 MM BOLT
192400 Battery Terminal

 Length: 54 mm
Cable size/max: 70 mm²
Cable size/min: 10 mm²
Cable connection:
10 mm bolt
Polarity: Positive

Material: Moulded brass

192401 Battery Terminal

 Length: 54 mm
Cable size/max: 70 mm²
Cable size/min: 10 mm²
Cable connection:
10 mm bolt
Polarity: Negative

Material: Moulded brass

TIN PLATED			
190213 Battery Terminal			
		ID: 18.5 mm Cable size/max: 70 mm ² Cable size/min: 10 mm ² Cable connection: 10 mm bolt Polarity: Positive	Material: Moulded brass Tin plated: Yes
190214 Battery Terminal			
		ID: 15.9 mm Cable size/max: 70 mm ² Cable size/min: 10 mm ² Cable connection: 10 mm bolt Polarity: Negative	Material: Moulded brass Tin plated: Yes
W/ M6 BOLT AND WING NUT			
TIN PLATED			
191134 Battery Terminal			
<i>w/ wing nut.</i>			
		ID: 15.9 mm Cable size/max: 70 mm ² Cable size/min: 6 mm ² Cable connection: 8 mm bolt Polarity: Negative	Material: Moulded brass Tin plated: Yes
W/ M10 BOLT AND WING NUT			
192402 Battery Terminal			
<i>w/ wing nut.</i>			
		Length: 54 mm Cable size/max: 70 mm ² Cable size/min: 10 mm ² Cable connection: 10 mm bolt Polarity: Positive	Material: Moulded brass
192403 Battery Terminal			
<i>w/ wing nut.</i>			
		Length: 54 mm Cable size/max: 70 mm ² Cable size/min: 10 mm ² Cable connection: 10 mm bolt Polarity: Negative	Material: Moulded brass
TIN PLATED			
191133 Battery Terminal			
<i>w/ wing nut.</i>			
		ID: 18.5 mm Cable size/max: 70 mm ² Cable size/min: 10 mm ² Cable connection: 10 mm bolt Polarity: Positive	Material: Moulded brass Tin plated: Yes

25 MM²
192163 Battery Terminal

 ID: 19 mm
 Cable size/max: 25 mm²
 Polarity: Positive

Material: Moulded brass

192164 Battery Terminal

 ID: 17 mm
 Cable size/max: 25 mm²
 Polarity: Negative

Material: Moulded brass

W/ SWITCH
192493 Battery Terminal

Polarity: Negative

 Switch: w/
 Material: Moulded brass
 Cable w/fuse: Yes

16-35 MM²
TIN PLATED
190012 Battery Terminal

 ID: 18.5 mm
 Cable size/max: 35 mm²
 Cable size/min: 16 mm²
 Cable connection: 8 mm bolt
 Polarity: Positive

 Material: Moulded brass
 Tin plated: Yes

190013 Battery Terminal

 ID: 15.9 mm
 Cable size/max: 35 mm²
 Cable size/min: 16 mm²
 Cable connection: 8 mm bolt
 Polarity: Negative

 Material: Moulded brass
 Tin plated: Yes

190211 Battery Terminal

 Servicing: Fiat, Mazda, Suzuki, Nissan - Visit www.hc-cargo.com for further information

 ID: 13 mm
 Cable size/max: 35 mm²
 Cable size/min: 16 mm²
 Polarity: Positive

 Material: Moulded brass
 Tin plated: Yes

EL. SPECIFICATIONS	DIMENSIONS	ADDITIONAL SPECIFICATIONS
190212 Battery Terminal Servicing: Fiat, Mazda, Suzuki, Nissan - Visit www.hc-cargo.com for further information		
	ID: 11.2 mm Cable size/max: 35 mm ² Cable size/min: 16 mm ² Polarity: Negative	Material: Moulded brass Tin plated: Yes
35-70 MM²		
TIN PLATED		
191166 Battery Terminal		
	ID: 18.5 mm Cable size/max: 70 mm ² Cable size/min: 35 mm ² Polarity: Positive	Material: Moulded brass Tin plated: Yes
191167 Battery Terminal		
	ID: 15.9 mm Cable size/max: 70 mm ² Cable size/min: 35 mm ² Polarity: Negative	Material: Moulded brass Tin plated: Yes
35-95 MM²		
TIN PLATED		
193000 Battery Terminal		
<i>Heavy duty.</i>		
	ID: 18.5 mm Cable size/max: 95 mm ² Cable size/min: 35 mm ² Polarity: Positive	Material: Moulded brass Tin plated: Yes
193001 Battery Terminal		
<i>Heavy duty.</i>		
	ID: 15.9 mm Cable size/max: 95 mm ² Cable size/min: 35 mm ² Polarity: Negative	Material: Moulded brass Tin plated: Yes
TIN PLATED W/DOUBLE SCREW		
190866 Battery Terminal		
<i>w/ double screws and screw for AUX.</i>		
	ID: 18.5 mm Cable size/max: 95 mm ² Cable size/min: 35 mm ² Cable connection: Dual Polarity: Positive	Material: Moulded brass Tin plated: Yes

190867 Battery Terminal
w/ double screws and screw for AUX.

 ID: 15.9 mm
 Cable size/max: 95 mm²
 Cable size/min: 35 mm²
 Cable connection: Dual
 Polarity: Negative

 Material: Moulded brass
 Tin plated: Yes

35 MM²
TIN PLATED
191244 Battery Terminal

 ID: 18.5 mm
 Cable size/max: 35 mm²
 Cable size/min: 35 mm²
 Polarity: Positive

 Material: Moulded brass
 Tin plated: Yes

191245 Battery Terminal

 ID: 15.9 mm
 Cable size/max: 35 mm²
 Cable size/min: 35 mm²
 Polarity: Negative

 Material: Moulded brass
 Tin plated: Yes

50 MM²
TIN PLATED
190202 Battery Terminal

 ID: 18.5 mm
 Cable size/max: 50 mm²
 Cable size/min: 50 mm²
 Polarity: Positive

 Material: Moulded brass
 Tin plated: Yes

190203 Battery Terminal









 ID: 15.9 mm
 Cable size/max: 50 mm²
 Cable size/min: 50 mm²
 Polarity: Negative

 Material: Moulded brass
 Tin plated: Yes

70 MM²
TIN PLATED
191989 Battery Terminal

 ID: 18.5 mm
 Cable size/max: 70 mm²
 Cable size/min: 70 mm²
 Polarity: Positive

 Material: Moulded brass
 Tin plated: Yes

EL. SPECIFICATIONS	DIMENSIONS	ADDITIONAL SPECIFICATIONS
19190 Battery Terminal 	ID: 15.9 mm Cable size/max: 70 mm ² Cable size/min: 70 mm ² Polarity: Negative	Material: Moulded brass Tin plated: Yes
193166 Battery Terminal 	Length: 50 mm Cable size/max: 70 mm ² Cable size/min: 10 mm ² Polarity: Positive	Material: Moulded brass No./connections: 2 Tin plated: Yes
193167 Battery Terminal 	Length: 50 mm Cable size/max: 70 mm ² Cable size/min: 10 mm ² Polarity: Negative	Material: Moulded brass No./connections: 2 Tin plated: Yes
ACCESSORIES		
190215 Nut & Bolt 	Collar length: 38 mm Thread size: M8	Material: Moulded brass
192681 Terminal Cover 	Cable dia.: 17 mm Length: 52 mm Width: 35 mm	Colour: Red Material: PVC
192682 Terminal Cover 	Cable dia.: 17 mm Length: 52 mm Width: 35 mm	Colour: Black Material: PVC
192888 Terminal Cover Right + 	Cable dia.: 17 mm Length: 52 mm Height: 22 mm Width: 35 mm	Colour: Red Material: PVC
192889 Terminal Cover Left - 	Cable dia.: 17 mm Length: 52 mm Height: 22 mm Width: 35 mm	Colour: Black Material: PVC

192890 Terminal Cover Left -

Cable dia.: 17 mm
 Length: 52 mm
 Height: 22 mm
 Width: 35 mm

Colour: Red
 Material: PVC

192891 Terminal Cover Right -

Cable dia.: 17 mm
 Length: 52 mm
 Height: 22 mm
 Width: 35 mm

Colour: Black
 Material: PVC

FORMPRESSED
25-40 MM²
17 MM
192075 Battery Terminal

ID: 17 mm
 Cable size/max: 40 mm²
 Cable size/min: 25 mm²
 Polarity: Negative

Material: Compressed

192076 Battery Terminal
For M8 stud connection.

ID: 17 mm
 Cable size/max: 40 mm²
 Cable size/min: 25 mm²
 Polarity: Positive

Material: Compressed

19 MM
191820 Battery Terminal
Terminal: HC-CARGO 191822, -827.

ID: 19 mm
 Cable size/max: 40 mm²
 Cable size/min: 25 mm²
 Polarity: Positive

Material: Compressed
 No./connections: 2

3 TERMINAL OUTLETS
191821 Battery Terminal
Terminal: HC-CARGO 191822, -829.

ID: 19 mm
 Polarity: Positive







Material: Compressed
 No./connections: 3

192234 Battery Terminal
Terminal: HC-CARGO 191822, -829.

ID: 17 mm
 Polarity: Negative

Material: Compressed
 No./connections: 3

10-20 MM ²			
17 MM			
192074 Battery Terminal			
		ID: 17 mm Cable size/max: 20 mm ² Cable size/min: 10 mm ² Polarity: Negative	Material: Compressed
FOR FRENCH APPLICATIONS			
192053 Battery Terminal			
Servicing: French applications - Visit www.hc-cargo.com for further information			
		ID: 19 mm Polarity: Positive	Colour: Red Material: Compressed
192054 Battery Terminal			
Servicing: French applications - Visit www.hc-cargo.com for further information			
		ID: 17 mm Polarity: Negative	Colour: Green Material: Compressed
LEADS AND EARTH STRAPS			
192018 Battery Connection Cable			
		Length: 300 mm Cable size/max: 35 mm ² Angled: 90° Polarity: Pos./Neg.	No./wires: 1008/0.2
192020 Earth Strap			
	Amp: 110	Length: 200 mm Cable size/max: 22 mm ²	No./wires: 432/0.26
192021 Earth Strap			
	Amp: 110	Length: 250 mm Cable size/max: 22 mm ²	No./wires: 432/0.26
192022 Earth Strap			
	Amp: 110	Length: 300 mm Cable size/max: 22 mm ²	No./wires: 432/0.26

	EL. SPECIFICATIONS	DIMENSIONS	ADDITIONAL SPECIFICATIONS
190223 Earth Strap 	Amp: 110	Length: 350 mm Cable size/max: 22 mm ²	No./wires: 432/0.26
190224 Earth Strap 	Amp: 110	Length: 400 mm Cable size/max: 22 mm ²	No./wires: 432/0.26
190225 Earth Strap 	Amp: 110	Length: 400 mm Cable size/max: 22 mm ²	No./wires: 432/0.26
190226 Earth Strap 	Amp: 110	Length: 500 mm Cable size/max: 22 mm ²	No./wires: 432/0.26
190228 Earth Strap 	Amp: 82	Length: 200 mm Cable size/max: 16 mm ²	No./wires: 228/0.25
190229 Earth Strap 	Amp: 82	Length: 250 mm Cable size/max: 16 mm ²	No./wires: 228/0.25
190230 Earth Strap 	Amp: 82	Length: 350 mm Cable size/max: 16 mm ²	No./wires: 228/0.25

	EL. SPECIFICATIONS	DIMENSIONS	ADDITIONAL SPECIFICATIONS
190231 Earth Strap 	Amp: 82	Length: 400 mm Cable size/max: 16 mm ²	No./wires: 228/0.25
190232 Earth Strap 	Amp: 82	Length: 450 mm Cable size/max: 16 mm ²	No./wires: 228/0.25
190235 Starter Cable 		Length: 300 mm Cable size/max: 25 mm ² Polarity: Positive	No./wires: 742/0.2
190237 Starter Cable 		Length: 500 mm Cable size/max: 25 mm ² Polarity: Positive	No./wires: 742/0.2
190239 Starter Cable 		Length: 700 mm Cable size/max: 25 mm ² Polarity: Positive	No./wires: 742/0.2
190242 Starter Cable 		Length: 1000 mm Cable size/max: 25 mm ² Polarity: Positive	No./wires: 742/0.2
191679 Battery Connection Cable 		Length: 300 mm Cable size/max: 50 mm ² Angled: 90° Polarity: Pos./Neg.	No./wires: 378/0.41

INDUSTRIAL BATTERY CONNECTORS

CB Series Details

	CB 50	CB 175	CB 350
	mm	mm	mm
A	19	28.5	28.5
B	6.4	11	35
C	18.2	27	35
D	36.5	55.6	69.8
E	47.6	79.4	108
F	80.9	133.3	182.6
G	11.5	19	27
H	15.9	25.4	33.3
J	3.7	6.7	6.7

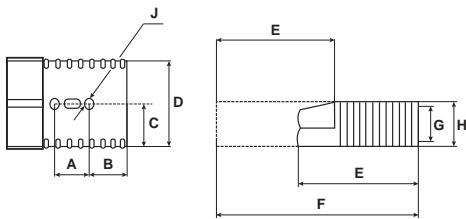

CBX Series Details

	CBX 175	CBX 350
	mm	mm
A	49.2	61.9
B	28.5	28.5
C	15.9	15.9
D	71.2	85.7
E	85.3	125.4
F	146.3	200
G	25.5	33.3

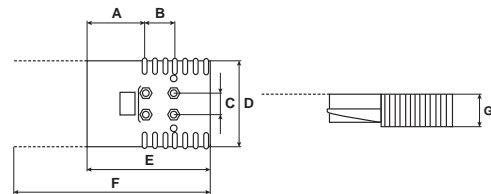

50 AMPERE

CB50	HC-CARGO	Max V	Amp	Temp. class °C	Colour	Cable size	Terminals	Handle	Dust cap
	180530	600	50	-40 - +125	Grey	6 mm ²	180390	180548	180516
	180531	600	50	-40 - +125	Red	6 mm ²	180390	180548	180516
	180532	600	50	-40 - +125	Black	6 mm ²	180390	180548	180516
	180381	600	50	-40 - +125	Grey	16 mm ²	180535	180548	180516
	180382	600	50	-40 - +125	Red	16 mm ²	180535	180548	180516
	180383	600	50	-40 - +125	Black	16 mm ²	180535	180548	180516

SPARE PARTS

180390 Terminals

Servicing: HC-CARGO 180381, -382, -383



Voltage: 600
Amp: 50
Cable dim.: 16 mm²

180535 Terminals

Servicing: HC-CARGO 180530, -531, -532



Voltage: 600
Amp: 50
Cable dim.: 6 mm²





ACCESSORIES

180548 Handle

Servicing: HC-CARGO 180381, -382, -383, -530, -531, -532



Colour: Red

181516 Dust Cap		Servicing: CB50								
										
80 AMPERE										
NF80		HC-CARGO	Max V	Amp	Temp. class	Colour	Heading type	Cable size		
		180542	150	80	-20°C - +90°C	Black	Female	25 mm ²		
		180543	150	80	-20°C - +90°C	Black	Male	25 mm ²		
		180562	150	80	-20°C - +90°C	Black	Female	16 mm ²		
		180563	150	80	-20°C - +90°C	Black	Male	16 mm ²		
100 AMPERE										
CB100		HC-CARGO	Max V	Amp	Temp. class	Colour	Heading type	Cable size	Handle	
		181501	150	100	-20°C - +90°C	Black	Female	16 mm ²	181505 (R)	
		181502	150	100	-20°C - +90°C	Black	Male	16 mm ²	181505 (R)	
		181503	150	100	-20°C - +90°C	Black	Female	25 mm ²	181505 (R)	
		181504	150	100	-20°C - +90°C	Black	Male	25 mm ²	181505 (R)	
ACCESSORIES										
181505 Handle		Servicing: HC-CARGO 181501, 181502, 181503, 181504								
								Colour: Red		
160 AMPERE										
NF160		HC-CARGO	Max V	Amp	Temp. class °C	Colour	Heading type	Cable size	Reducing bush	Handle
		181519	150	160	-20 - +90	Black	Female	50 mm ²	181521	180380 (B)
		181520	150	160	-20 - +90	Black	Male	50 mm ²	181521	Already present
ACCESSORIES										
180380 Handle		Servicing: HC-CARGO 180395, 180396, 181519, 181520								
								Colour: Black		
181521 Reducer Kit		Servicing: HC-CARGO 181519, 181520								
		Voltage: 150 Amp: 160	Cable dim.: 50/35 mm ²							

175 AMPERE

CB175	HC-CARGO	Max V	Amp	Temp. class °C	Colour	Heading type	Cable size	Terminals	Handle	Dust cap
	180384	600	175	-40 - +125	Grey	Female	50 mm ²	180392	180549 (G) 180391 (R)	180517
	180385	600	175	-40 - +125	Red	Female	50 mm ²	180392	180549 (G) 180391 (R)	180517
	180537	600	175	-40 - +125	Grey	Female	50 mm ²	180554	180549 (G) 180391 (R)	
	180538	600	175	-40 - +125	Red	Female	50 mm ²	180554	180549 (G) 180391 (R)	
	180533	600	175	-40 - +125	Grey	Female	35 mm ²	180536	180549 (G) 180391 (R)	180517
	180534	600	175	-40 - +125	Red	Female	35 mm ²	180536	180549 (G) 180391 (R)	180517

SPARE PARTS

180392 Terminals

Servicing: HC-CARGO 180384, -385

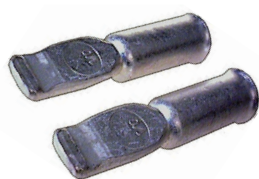

Voltage: 600
Amp: 175
Cable dim.: 50 mm²

180536 Terminals

Servicing: HC-CARGO 180533, 180534



Voltage: 600
Amp: 175
Cable dim.: 35 mm²

180554 Terminals

Servicing: HC-CARGO 180537, -538



Voltage: 600
Amp: 175
Cable dim.: 50 mm²

ACCESSORIES

180391 Handle

Servicing: HC-CARGO 180533, -534, -537, -538, -384, -385



Colour: Red

180549 Handle

Servicing: HC-CARGO 180533, -534, -537, -538, -384, -385



Colour: Grey

181517 Dust Cap

Servicing: CB175



250 AMPERE										
Y250	HC-CARGO	Max V	Amp	Colour	Heading type	Cable size	Terminals	Handle	Self close lid	
	180580	150	250	Yellow	Male	50 mm ²	180582	180328	181329	
	180581	250	250	Black	Female	50 mm ²	180583	180328	181329	
SPARE PARTS										
181605 Terminals		Servicing: HC-CARGO 180581								
	Amp: 250							Gender: Female		
181606 Terminals		Servicing: HC-CARGO 180580								
	Amp: 250							Gender: Male		
ACCESSORIES										
180582 Terminals		Servicing: HC-CARGO 180580								
<i>Single delivered.</i>										
	Amp: 250							Gender: Male		
180583 Terminals		Servicing: HC-CARGO 180581								
<i>Single delivered.</i>										
	Amp: 250							Gender: Female		
181328 Rubber Boot		Servicing: HC-CARGO 180580								
								Protection degree: IP 66		
181329 Lid		Servicing: HC-CARGO 180581								
<i>Self-closed.</i>										
										

181594 Joint interfacial

Servicing: HC-CARGO 180580

300 AMPERE

E300	HC-CARGO	Max V	Amp	Colour	Cable size	Terminals
	180575	250	300	Yellow	70 mm ²	w/brazed solid silver tip
	180577	250	300	Yellow	70 mm ²	w/brazed solid silver tip

320 AMPERE

NF320	HC-CARGO	Max V	Amp	Temp. class °C	Colour	Heading type	Cable size	Aux terminals
	180395	150	320	-20 - +90	Black	Female	90/70 mm ²	180916
	180396	150	320	-20 - +90	Black	Male	90/70 mm ²	

ACCESSORIES
180616 Terminals

Servicing: HC-CARGO 180395

 Voltage: 150
Amp: 160

Type: Female

350 AMPERE

CB350	HC-CARGO	Max V	Amp	Temp. class °C	Colour	Heading type	Cable size	Handle
	180386	600	350	-40 - +125	Grey	Female	70 mm ²	180550 (G)
	180387	600	350	-40 - +125	Red	Female	70 mm ²	180550 (G)

CBX350	HC-CARGO	Max V	Amp	Temp. class °C	Colour	Heading type	Cable size
	180551	600	350	-40 - +125	Grey	Female	70 mm ²
	180552	600	350	-40 - +125	Red	Female	70 mm ²

ACCESSORIES
180550 Handle

Servicing: HC-CARGO 180386, -387, 180551, -552



Colour: Grey

PLUGS & SOCKETS

DIN AND CIGARETTE LIGHTER

160294 Cigarette Lighter

Servicing: Alfa Romeo, Audi, Opel, VW - Visit www.hc-cargo.com for further information

Universal.



Voltage: 12

Light: No

160300 Cigarette Lighter

Universal.



Voltage: 12

Light: Yes

160551 Cigarette Lighter

Universal.



Voltage: 24

Light: Yes

SOCKETS

160409 Lighter Socket

Universal.



Voltage: 12/24
Amp: 20

Light: w/o
Cap: w/
Resistor: w/o

180038 DIN Socket

Standard DIN.



ID/mount. hole:
18.5 mm

Material: Nickel plated brass
No./mounting holes: 1
Cap: w/
Male/female: Female
DIN norm: 72591
ISO norm: 4165

180115 DIN Socket

Universal.



Dist. mount. holes:
46 mm

Material: Cast aluminum
No./mounting holes: 2
No./poles: 2
Male/female: Female
DIN norm: 72591
ISO norm: 4165

	EL. SPECIFICATIONS	DIMENSIONS	ADDITIONAL SPECIFICATIONS
<p>180157 DIN Socket</p> 		<p>ID/mount. hole: 18.5 mm</p>	<p>Material: Nickel plated brass No./poles: 2 Cap: w/ Male/female: Female DIN norm: 72591 ISO norm: 4165</p>
<p>180315 DIN Socket <i>Universal. Fits HC-CARGO 180629.</i></p> 		<p>Dist. mount. holes: 46 mm</p>	<p>Material: Plastic No./mounting holes: 2 No./poles: 2 Male/female: Female</p>
<p>180354 Coupling Socket <i>DIN - coupling socket extension connector, universal. Standard</i></p> 			<p>No./poles: 1 Male/female: Female</p>
<p>180376 DIN Socket</p>	<p>Servicing: HC-CARGO 170292, 170387, 170405, 170788, 170406, 170562, 170789, 170537, 171576, 170419, 170460</p>		
<p><i>Also used in sockets for beacons.</i></p> 		<p>ID/mount. hole: 18.5 mm</p>	<p>Material: Brass No./poles: 1 Male/female: Female DIN norm: 72591</p>
<p>180377 DIN Socket</p>	<p><i>Also used in sockets for beacons.</i></p>		
		<p>ID/mount. hole: 18.5 mm</p>	<p>Material: Brass No./poles: 2 Male/female: Female DIN norm: 72591</p>
<p>181275 DIN Socket</p> 		<p>ID/mount. hole: 18.5 mm</p>	<p>No./poles: 2 Cap: w/ Male/female: Female DIN norm: 72591 ISO norm: 4165</p>
<p>181548 Twin Socket Cigar Adapter</p>	<p><i>w/ 60 cm cable.</i></p>		
	<p>Voltage: 12 Amp: 15</p>		

181549 Twin Socket Cigar Adapter



Voltage: 12
Amp: 15

181550 Twin Socket Cigar Adapter

w/ 2 USB plugs. Cable length: 650 mm.



Voltage: 12
Amp: 10

181575 Socket

Universal. w/ 30 cm cable 0.8 mm².



181601 USB Adapter

2 horizontally built-in ports, charging two USB devices simultaneously.



Voltage: 12/24
Amp: 3

Material: PVC

181616 DIN Socket

300 mm cable.



Voltage: 6/24
Amp: 16

Cable dim.: 2x2.5 mm²
Mount. hole dia.:
18.4 mm
Temp.: -40 - +105 °C

Colour: Black
Material: Shockproof plastic
No./poles: 2
Male/female: Female
ISO norm: 4165
Protection degree: IP 67
Mount.: Screw
Connection: Cable

181631 USB Adapter

2 horizontally built-in ports, charging two USB devices simultaneously.



Voltage: 12/24
Amp: 2.1

Colour: White/black
Material: Polycarbonate

PLUGS

180113 DIN Plug

Universal. Fits HC-CARGO 180115.



Material: Plastic
No./poles: 2
Male/female: Male
DIN norm: 72591
ISO norm: 4165

180230 DIN Plug

Universal plug suitable for all cigarette lighter sockets. Also suitable for standard DIN socket.



Voltage: 12/24
Amp: <8

Material: Plastic
No./poles: 2
Male/female: Male
ISO norm: 4165

180287 DIN Plug

Universal plug suitable for all cigarette lighter sockets. Also suitable for standard DIN socket. w/ built-in 8 A fuse.



Voltage: 12/24

Material: Plastic
No./poles: 2
Male/female: Male
ISO norm: 4165

180399 DIN Plug

Universal. Fits HC-CARGO 180315.



Voltage: 12/24

Material: Plastic
No./poles: 2
Male/female: Male

181629 DIN Plug

Universal. Fits HC-CARGO 180315.



Voltage: 12/24

Material: Plastic
No./poles: 2
Male/female: Male

ACCESSORIES
171518 Coiled Cable

Servicing: HC-CARGO 170292, 170387, 170405, 170788, 170406, 170562, 170789, 170537, 171576, 170419, 170460



Working length: 2 m

Plug type: Cigar plug
Plug: 2
ISO norm: 4165

171562 Coiled Cable

Servicing: HC-CARGO 171763, 171764, 171494, 171495, 171496



Working length: 3 m

Plug type: Cigar plug

181579 Plug and Socket

Servicing: HC-CARGO 181629, 180315



Voltage: 12/24

Material: Plastic
No./mounting holes: 2
No./poles: 2

181602 USB Charging Kit		Servicing: HC-CARGO 181601, 181550, 181631	
Plug 1: Nokia N70/628/6300/N95. Plug 2: Sony PSP. Plug 3: I-Phone. Plug 4: Nokia 8600/6500C. Plug 5: Nintendo DS Lite. Plug 6: Motorola, Android. Plug 7: Samsung Trace/E900.			
			Material: PVC
ADAPTERS - 12/24 V			
7-7 PIN			
18201 Trailer Adapter		Servicing: HC-CARGO 181617	
	Voltage: 12/24		Plug type: 24N, 12N Plug 1: 7 Plug 2: 7 ISO norm: 1724 ISO norm 2: 1185
ADAPTERS 12 V			
2-2 PIN			
181622 Splitter Cable		Servicing: HC-CARGO 181617	
	Voltage: 12	Cable dim.: 2x1 mm ² Length: 0.25 m	Plug 1: 2 Plug 2: 2
7-8 PIN			
181618 Trailer Adapter		Servicing: HC-CARGO 181617	
	Voltage: 12	Cable dim.: 6x1 mm ² Length: 8.5 m	Plug type: 12N, Bayonet Colour: Black Material: ABS plastic Plug 1: 7 Plug 2: 8 ISO norm: 1724
181619 Trailer Adapter		Servicing: HC-CARGO 181617	
	Voltage: 12	Cable dim.: 6x1 mm ² Length: 11 m	Plug type: 12N, Bayonet Colour: Black Material: ABS plastic Plug 1: 7 Plug 2: 8 ISO norm: 1724
181620 Trailer Adapter		Servicing: HC-CARGO 181617	
	Voltage: 12	Cable dim.: 6x1 mm ² Length: 14 m	Plug type: 12N, Bayonet Colour: Black Material: ABS plastic Plug 1: 7 Plug 2: 8 ISO norm: 1724

	EL. SPECIFICATIONS	DIMENSIONS	ADDITIONAL SPECIFICATIONS
181621 Socket with cable			
	Servicing: HC-CARGO 181617		
	Voltage: 12	Cable dim.: 4x1 mm ² Length: 2 m	Plug type: 12N, 4 pin Power Seal Colour: Black Material: ABS plastic Plug 1: 7 Plug 2: 4 ISO norm: 1724
7-13 PIN			
180221 Trailer Adapter			
	Voltage: 12	Cable length: 1 m	Plug 1: 7 Plug 2: 13 Cable: w/ ISO norm: 11446 ISO norm 2: 1724
181273 Trailer Adapter			
<i>Extremely compact.</i>			
	Voltage: 12		Plug 1: 7 Plug 2: 13 ISO norm: 1724 ISO norm 2: 11446
181461 Trailer Adapter			
Servicing: Hobby and Hymer caravans - Visit www.hc-cargo.com for further information			
<i>Connect pos. 2/54 on 7-pin to pos. 9 and 10 on 13-pin. (continuous power supply) and connect 3/31 on 7-pin to pos. 3.11 and 13 on 13-pin.</i>			
	Voltage: 12		Plug 1: 7 Plug 2: 13 ISO norm: 1724 ISO norm 2: 11446
13-7 PIN			
180213 Trailer Adapter			
	Voltage: 12	Cable length: 0.8 m	Plug 1: 13 Plug 2: 7 Cable: w/ ISO norm: 11446 ISO norm 2: 1724
180298 Trailer Adapter			
	Voltage: 12		Plug 1: 13 Plug 2: 7 Cable: w/ ISO norm: 11446 ISO norm 2: 1724
180305 Trailer Adapter			
	Voltage: 12		Plug 1: 13 Plug 2: 7 ISO norm: 11446 ISO norm 2: 1724

	EL. SPECIFICATIONS	DIMENSIONS	ADDITIONAL SPECIFICATIONS
180332 Trailer Adapter		Voltage: 12	Plug type: Multicon Plug 1: 13 Plug 2: 7-13 ISO norm: 11446 ISO norm 2: 1724
180373 Trailer Adapter		Voltage: 12	Cable length: 0.1 mm Plug 1: 7 Plug 2: 13 Cable: w/ ISO norm: 11446 ISO norm 2: 1724
180574 Trailer Adapter		Voltage: 12	Cable length: 0.3 mm Plug type: 12N/12S Plug 1: 13 Plug 2: 7 Cable: w/ ISO norm: 11446 ISO norm 2: 1724
180606 Trailer Adapter	<i>Extremely compact.</i> 	Voltage: 12	Plug 1: 13 Plug 2: 7 ISO norm: 11446 ISO norm 2: 1724
ADAPTERS 24 V			
15-7 PIN			
180327 Trailer Adapter	<i>w/ 42 windings.</i> 	Voltage: 24	Cable dim.: 6x1+1x2.5 mm ² Cable length: 3.5 mm Plug type: 24N/24S, Europe Colour: Black Material: Polyurethan Plug 1: 15 Plug 2: 2x7 Cable: w/ ISO norm: 12098 ISO norm 2: 1185 ISO norm 3: 3731
180328 Trailer Adapter		Voltage: 24	Cable dim.: 6x1+1x2.5 mm ² Cable length: 0.4 mm Plug type: 24N/24S, Europe Colour: Black Material: Aluminium Plug 1: 15 Plug 2: 2x7 Cable: w/ ISO norm: 12098 ISO norm 2: 1185 ISO norm 3: 3731
180622 Trailer Adapter		Voltage: 24	Plug type: 24N/24S Plug 1: 15 Plug 2: 7 ISO norm: 12098 ISO norm 2: 1185 ISO norm 3: 3721

DISTRIBUTOR BOX

181617 Distribution Box



Dim.: 160x60x120 mm
 Input: 8 pin
 Outlet: 6x4 pin + 2x3 pin

Protection degree: IP 54

TRAILER SOCKETS - 12 V

3 PIN

180306 Socket



Voltage: 12
 Amp: 5/25/25

Connection: Terminal

Colour: Black
 Material: Plastic
 No./poles: 3
 Male/female: Female

180307 Socket



Voltage: 12
 Amp: 5/25/25

Connection: Terminal

Colour: Black
 Material: Plastic
 No./poles: 3
 Male/female: Female
 DIN norm: 9680

7 PIN

180110 Trailer Socket

Servicing: HC-CARGO 180107, 180108, 180147, 181547



Voltage: 12

Connection: Screw

Plug type: 12N
 Colour: Black
 Material: Shock thermo plastic
 No./poles: 7
 Male/female: Female
 DIN norm: 72577
 ISO norm: 1724

180150 Coupling Socket

Servicing: HC-CARGO 180110, 180218, 180293, 181485



Voltage: 12

Connection: Screw

Plug type: 12N
 Colour: Black
 Material: Shock thermo plastic
 No./poles: 7
 Male/female: Female
 DIN norm: 72579
 ISO norm: 1724

180218 Trailer Socket

Servicing: HC-CARGO 180107, 180108, 180147, 181547



Voltage: 12

Connection: Screw

Plug type: 12N
 Colour: Black
 Material: Cast aluminum
 No./poles: 7
 Male/female: Female
 DIN norm: 72577
 ISO norm: 1724

	EL. SPECIFICATIONS	DIMENSIONS	ADDITIONAL SPECIFICATIONS
180239 Trailer Socket Servicing: HC-CARGO 180238			
<i>w/ changed central contact 7/58L. w/ grey cap.</i>			
	Voltage: 12	Connection: Screw	Plug type: 12S Colour: Black Material: Shock thermo plastic No./poles: 7 Male/female: Female ISO norm: 3732
180293 Trailer Socket Servicing: HC-CARGO 180107, 180108, 180147, 181547			
	Voltage: 12	Connection: Terminal	Plug type: 12N Colour: Black Material: Shock thermo plastic No./poles: 7 Male/female: Female DIN norm: 72577 ISO norm: 1724
180620 Coupling Socket Servicing: HC-CARGO 180239			
<i>w/ changed 7/58L contact.</i>			
	Voltage: 12	Connection: Cable	Plug type: 12S Colour: Grey Material: Shock thermo plastic No./poles: 7 Male/female: Female
181485 Trailer Socket Servicing: HC-CARGO 180107, 180108, 180147, 181547			
<i>w/ rear fog light cut-off.</i>			
	Voltage: 12	Connection: Screw	Plug type: 12N Colour: Black Material: Shock thermo plastic No./poles: 7 Male/female: Female DIN norm: 72577 ISO norm: 1724
181604 Trailer Socket Servicing: HC-CARGO 180107, 180108, 180147, 181547			
<i>Micro and mechanical switch.</i>			
	Voltage: 12 Amp: 6	Connection: Screw	Plug type: 12N Colour: Black Material: Shock thermo plastic No./poles: 7 Male/female: Female DIN norm: 72577 ISO norm: 1724
13 PIN			
180214 Trailer Socket 13-Pol Servicing: HC-CARGO 180212			
<i>Trailer socket kit: HC-CARGO 180405.</i>			
	Voltage: 12	Connection: Screw	Colour: Black Locking device: Bayonet Material: Nickel plated brass No./poles: 13 Male/female: Female DIN norm: 72570 ISO norm: 11446 Protection degree: Splash proof
181274 Trailer Socket Servicing: HC-CARGO 180212			
<i>w/ micro switch, that switch over the rear fog lamps from car to trailer. Trailer socket kit: HC-CARGO 180405.</i>			
	Voltage: 12	Connection: Screw	Colour: Black Locking device: Bayonet Material: Nickel plated brass No./poles: 13 Male/female: Female DIN norm: 72570 ISO norm: 11446 Protection degree: Splash proof

181576 Coupling Socket

Voltage: 12

Connection: Screw

 Colour: Black
 Material: Shockproof plastic
 No./poles: 13
 Male/female: Female
 ISO norm: 11446

13-7 PIN
180329 Trailer Socket

Servicing: HC-CARGO 180330

w/ micro switch, that switch over the rear fog lamps from car to trailer.

Voltage: 12

Connection: Screw

 Plug type: Multicon
 Colour: Black
 Material: Shock thermo plastic
 No./poles: 7/13
 Male/female: Female
 ISO norm: 1724

SPARE PARTS
180249 Rubber Gasket

Servicing: HC-CARGO 180110, 180218, 180239, 180293, 181485



No./poles: 7

181510 Rubber Gasket

Servicing: HC-CARGO 180110, 180218, 180239, 180293, 181485

181582 Rubber Gasket

Servicing: HC-CARGO 180214, 181274

w/ 90° cable bulge.

 Material: Plastics
 No./poles: 13

TRAILER SOCKETS - 24 V
3 PIN
180402 Trailer Socket

Voltage: 6/24

Connection: Screw

 Colour: Black
 Material: Shock thermo plastic
 No./poles: 3
 Male/female: Female

5 PIN			
180243 ABS Socket			
<i>w/ ejector device for correct plug/socket connection. Incl. pins 3x1.5+2x4 mm².</i>			
	Voltage: 24		Plug type: ABS No./poles: 5 Male/female: Female DIN norm: 74001 ISO norm: 7638
181467 ABS Socket			
<i>Screw connection w/ wirecolour indication.</i>			
	Voltage: 24		Plug type: ABS Locking device: Metal bracket No./poles: 5 Male/female: Female ISO norm: 7638
7 PIN			
180112 Trailer Socket		Servicing: HC-CARGO 180296, 180351, 180111, 180154	
	Voltage: 24	Connection: Terminal	Plug type: 24N, Europe Colour: Black Material: Shock thermo plastic No./poles: 7 Male/female: Female DIN norm: 72579 ISO norm: 1185
180153 Trailer Socket		Servicing: HC-CARGO 180296, 180351, 180111, 180154	
	Voltage: 24	Connection: Screw	Plug type: 24N, Europe Colour: Black Material: Shock thermo plastic No./poles: 7 Male/female: Female DIN norm: 72579 ISO norm: 1185
180219 Trailer Socket		Servicing: HC-CARGO 180296, 180351, 180111, 180154	
	Voltage: 24	Connection: Screw	Plug type: 24N, Europe Material: Cast aluminum No./poles: 7 Male/female: Female DIN norm: 72579 ISO norm: 1185
180240 Trailer Socket		Servicing: HC-CARGO 180568, 180610, 180624	
<i>w/ changed 1/31 contact. w/ grey cap.</i>			
	Voltage: 24	Connection: Screw	Plug type: 24S, Europe Colour: Black Material: Shock thermo plastic No./poles: 7 Male/female: Female ISO norm: 3731

	EL. SPECIFICATIONS	DIMENSIONS	ADDITIONAL SPECIFICATIONS
180296 Trailer Socket Servicing: HC-CARGO 180112, 180153, 180219, 180607, 180297			
	Voltage: 24	Connection: Terminal	Plug type: 24N, Europe Material: Cast aluminum No./poles: 7 Male/female: Female DIN norm: 72579 ISO norm: 1185
180351 Trailer Socket Servicing: HC-CARGO 180112, 180153, 180219, 180607, 180297			
<i>16x flat tongue.</i>			
	Voltage: 24	Connection: Terminal	Plug type: 24N, Europe Material: Cast aluminum No./poles: 7 Male/female: Female DIN norm: 72579 ISO norm: 1185
180568 Trailer Socket Servicing: HC-CARGO 180240, 180569, 180608, 180241			
<i>w/ changed 1/31 contact. w/ grey cap.</i>			
	Voltage: 24	Connection: Terminal	Plug type: 24S, Europe Colour: Black Material: Shock thermo plastic No./poles: 7 Male/female: Female ISO norm: 3731
180569 Trailer Socket Servicing: HC-CARGO 180568, 180610, 180624			
<i>w/ changed 1/31 contact. w/ grey cap.</i>			
	Voltage: 24	Connection: Terminal	Plug type: 24S, Europe Material: Cast aluminum No./poles: 7 Male/female: Female ISO norm: 3731
180571 EBS Socket			
<i>w/ ejector device for correct plug/socket connection. Incl. pins 3x1.5+2x4 mm².</i>			
	Voltage: 24	Connection: Terminal	Plug type: EBS No./poles: 7 Male/female: Female DIN norm: 74001 ISO norm: 7638
180607 Trailer Socket Servicing: HC-CARGO 180296, 180351, 180111, 180154			
	Voltage: 24	Connection: Terminal	Plug type: 24N, Europe No./poles: 7 Male/female: Female DIN norm: 72579 ISO norm: 1185 Protection degree: IP 54 ADR-approved: Yes
180608 Trailer Socket Servicing: HC-CARGO 180568, 180610, 180624			
<i>w/ changed 1/31 contact. w/ grey cap.</i>			
	Voltage: 24	Connection: Terminal	Plug type: 24S, Europe Colour: Black Material: Shock thermo plastic No./poles: 7 Male/female: Female ISO norm: 3731 Protection degree: IP 54 ADR-approved: Yes

181470 EBS Socket

Screw connection w/ wirecolour indication.



Voltage: 24

Plug type: EBS
 Locking device: Metal bracket
 No./poles: 7
 Male/female: Female
 ISO norm: 7638

13 PIN
180253 EBS Socket

Incl. pins 12x1+1x2.5 mm². Weather proof.



Voltage: 24

No./poles: 13
 Male/female: Female
 DIN norm: 74001
 ISO norm: 12098
 ADR-approved: Yes
 GGVs approval: Yes

14 PIN
180352 Trailer Socket

Servicing: HC-CARGO 180353

For max. 6 mm² cable. Socket and plug can be disconnected automatically.



Voltage: 24

Colour: Black
 Material: Shock thermo plastic
 No./poles: 14
 Male/female: Female

15 PIN
180286 EBS Socket

w/ locking device preventing accidental disengagement. Incl. terminals 10x1.5 + 2x1 + 3x2.5 mm².



Voltage: 24

No./poles: 15
 Male/female: Female
 DIN norm: 72570
 ISO norm: 12098
 ADR-approved: Yes
 GGVs approval: Yes

181473 EBS Socket

Voltage: 24

Connection: Screw

Locking device: Metal bracket
 No./poles: 15
 Male/female: Female
 DIN norm: 72570
 ISO norm: 12098
 Protection degree: Waterproof
 ADR-approved: Yes
 GGVs approval: Yes

181474 EBS Socket

Voltage: 24

Connection: Screw

Locking device: Bayonet
 No./poles: 15
 Male/female: Female
 DIN norm: 72570
 ISO norm: 12098
 Protection degree: Waterproof
 ADR-approved: Yes
 GGVs approval: Yes

ACCESSORIES
180611 Terminal Coupling

Servicing: HC-CARGO 180112, 180569, 180607, 180608, 180241, 180297

For trailer sockets.



Voltage: 24

 Plug type: Europe
 Colour: White
 No./poles: 7
 Male/female: Multiplug

TRAILER SOCKETS - 6/24 V
4 PIN
180404 Trailer Socket

Voltage: 6/24

Connection: Screw

 Colour: Black
 Material: Shock thermo plastic
 No./poles: 4
 Male/female: Female
 DIN norm: 72575

TRAILER PLUGS - 12 V
7 PIN
180107 Trailer Plug

Servicing: HC-CARGO 180110, 180218, 180293, 181485



Voltage: 12

Connection: Screw

 Plug type: 12N
 Material: Cast aluminum
 No./poles: 7
 Male/female: Male
 DIN norm: 72577
 ISO norm: 1724

180108 Trailer Plug

Servicing: HC-CARGO 180110, 180218, 180293, 181485



Voltage: 12

Connection: Screw

 Plug type: 12N
 Colour: Black
 Material: Shock thermo plastic
 No./poles: 7
 Male/female: Male
 DIN norm: 72577
 ISO norm: 1724

180147 Trailer Plug

Servicing: HC-CARGO 180110, 180218, 180293, 181485



Voltage: 12

 Connection: Snap-on
 Mount.: Screw

 Plug type: 12N
 Colour: Black
 Material: Shock thermo plastic w/
 snap-on session
 No./poles: 7
 Male/female: Male
 DIN norm: 72577
 ISO norm: 1724

180238 Trailer Plug

Servicing: HC-CARGO 180239

w/ changed 7/58L contact.



Voltage: 12

Connection: Screw

 Plug type: 12S
 Colour: Grey
 Material: Shock thermo plastic
 No./poles: 7
 Male/female: Male
 ISO norm: 3732

	EL. SPECIFICATIONS	DIMENSIONS	ADDITIONAL SPECIFICATIONS
180308 Plug			
	Voltage: 12 Amp: 5/25/25	Connection: Terminal	Colour: Black Material: Plastic No./poles: 3 Male/female: Male DIN norm: 9680
181547 Trailer Plug Servicing: HC-CARGO 180110, 180218, 180293, 181485			
<i>w/ rubber grommet for 1 cable. Grommet for 2 cables: HC-CARGO 181581.</i>			
	Voltage: 12	Connection: Terminal	Plug type: 12N Colour: Black Material: Plastic No./poles: 7 Male/female: Male DIN norm: 72577 ISO norm: 1724
13 PIN			
180212 Trailer Plug Servicing: HC-CARGO 180214, 181274			
<i>Nickel plated brass pins.</i>			
	Voltage: 12	Connection: Screw	Colour: Black Locking device: Bayonet Material: Shock thermo plastic No./poles: 13 Male/female: Male DIN norm: 72570 ISO norm: 11446 Protection degree: Splash proof
13-7 PIN			
180330 Trailer Plug Servicing: HC-CARGO 180329			
<i>+ 6 contacts.</i>			
	Voltage: 12	Connection: Screw	Plug type: Multicon Colour: Black Material: Shock thermo plastic No./poles: 7-13 Male/female: Male ISO norm: 1724
TRAILER PLUGS - 24 V			
5 PIN			
180242 ABS Plug			
<i>Incl. tubes 3x1.5+2x4 mm² (HC-CARGO 191170).</i>			
	Voltage: 24	Connection: Terminal	Plug type: ABS Locking device: Metal bracket No./poles: 5 Male/female: Male ISO norm: 7638
181466 ABS Plug			
<i>Screw connection w/ wirecolour indication.</i>			
	Voltage: 24	Connection: Terminal	Plug type: ABS Locking device: Metal bracket No./poles: 5 Male/female: Male ISO norm: 7638

7 PIN

		EL. SPECIFICATIONS	DIMENSIONS	ADDITIONAL SPECIFICATIONS
180111 Trailer Plug				
Servicing: HC-CARGO 180112, 180153, 180219, 180607, 180297				
	Voltage: 24	Connection: Terminal	Plug type: 24N, Europe Colour: Black Material: Shock thermo plastic No./poles: 7 Male/female: Male DIN norm: 72579 ISO norm: 1185	
180154 Trailer Plug				
Servicing: HC-CARGO 180112, 180153, 180219, 180607, 180297				
	Voltage: 24	Connection: Screw	Plug type: 24N, Europe Colour: Black Material: Shock thermo plastic No./poles: 7 Male/female: Male DIN norm: 72579 ISO norm: 1185	
180220 Trailer Plug				
	Voltage: 24	Connection: Screw	Plug type: 24N, Europe Material: Cast aluminum No./poles: 7 Male/female: Male DIN norm: 72579 ISO norm: 1185	
180241 Trailer Plug				
Servicing: HC-CARGO 180568, 180610, 180624				
<i>w/ changed 1/31 contact. w/ grey plastic interior.</i>				
	Voltage: 24	Connection: Screw	Plug type: 24S, Europe Colour: Black Material: Shock thermo plastic No./poles: 7 Male/female: Male ISO norm: 3731	
180297 Trailer Plug				
Servicing: HC-CARGO 180296, 180351, 180111, 180154				
	Voltage: 24	Connection: Terminal	Plug type: 24N, Europe Material: Cast aluminum No./poles: 7 Male/female: Male DIN norm: 72579 ISO norm: 1185	
180570 EBS Plug				
<i>Incl. pins 5x1.5+2x4 mm². w/ locking device.</i>				
	Voltage: 24	Connection: Terminal	Plug type: EBS Locking device: Metal bracket No./poles: 7 Male/female: Male DIN norm: 40050 ISO norm: 7638 Protection degree: Waterproof	
180610 Trailer Plug				
Servicing: HC-CARGO 180240, 180569, 180608, 180241				
<i>w/ changed 1/31 contact. w/ grey plastic interior.</i>				
	Voltage: 24	Connection: Screw	Plug type: 24S, Europe Colour: Black Material: Shock thermo plastic No./poles: 7 Male/female: Male ISO norm: 3731 Protection degree: IP 54 ADR-approved: Yes	

180624 Trailer Plug <i>w/ changed 1/31 contact. w/ grey plastic interior.</i>		Servicing: HC-CARGO 180240, 180569, 180608, 180241	
	Voltage: 24	Connection: Screw	Plug type: 24S, Europe Material: Cast aluminum No./poles: 7 Male/female: Male ISO norm: 3731
181469 EBS Plug <i>Screw connection w/ wirecolour indication.</i>			
	Voltage: 24	Connection: Terminal	Plug type: EBS Locking device: Metal bracket No./poles: 7 Male/female: Male ISO norm: 7638 Protection degree: Waterproof
13 PIN			
180252 EBS Plug <i>Incl. pins 12x1+1x2.5 mm². Weather proof.</i>			
	Voltage: 24	Connection: Terminal	No./poles: 13 Male/female: Male DIN norm: 40050 ISO norm: 7638 ADR-approved: Yes GGVS approval: Yes
14 PIN			
180353 Trailer Plug <i>For max. 6 mm² cable. Socket and plug can be disconnected automatically.</i>		Servicing: HC-CARGO 180352	
	Voltage: 24		Colour: Black Material: Shock thermo plastic No./poles: 14 Male/female: Male
15 PIN			
180285 EBS Plug <i>Incl. pins 12x1.5+3x2.5 mm².</i>			
	Voltage: 24	Connection: Terminal	No./poles: 15 Male/female: Male DIN norm: 72570 ISO norm: 12098 ADR-approved: Yes GGVS approval: Yes
181472 EBS Plug 15-Pol			
	Voltage: 24	Connection: Screw	Locking device: Metal bracket No./poles: 15 Male/female: Male DIN norm: 72570 ISO norm: 12098 Protection degree: Waterproof GGVS approval: Yes

SPARE PARTS

191170 Tube Terminal Kit

Assortment for HC-CARGO 180242 (3x HC-CARGO 191168 + 2x HC-CARGO 191169).



Type: Female, ABS, EBS

ACCESSORIES

180612 Terminal Coupling

Servicing: HC-CARGO 180296, 180351, 180568, 180111, 180609



Voltage: 24

Plug type: Europe
Colour: Red
No./poles: 7

TRAILER PLUGS - 6/24 V

3 PIN

180401 Plug



Voltage: 6/24

Connection: Screw

Colour: Black
Material: Shock thermo plastic
No./poles: 3
Male/female: Male
DIN norm: 9680

4 PIN

180403 Plug



Voltage: 6/24

Connection: Screw

Colour: Black
Material: Shock thermo plastic
No./poles: 4
Male/female: Male
DIN norm: 72575

CABLE KITS 12 V

7 PIN

180001 Trailer Cable Kit



Voltage: 12

Length: 1.4 m

Cable type: Single core w/ flex
Socket type: 12N
Fixing materials: Yes
No./poles: 7
Gasket: Yes
DIN norm: 72577
ISO norm: 1724

180144 Trailer Cable Kit



Voltage: 12

Length: 1.4 m

Cable type: Multi core
Socket type: 12N
Fixing materials: Yes
No./poles: 7
Gasket: Yes
Male/female: Male
DIN norm: 72577
ISO norm: 1724

	EL. SPECIFICATIONS	DIMENSIONS	ADDITIONAL SPECIFICATIONS
180248 Trailer Cable Kit			
	Voltage: 12	Length: 2 m	Cable type: Multi core Socket type: 12N Fixing materials: Yes No./poles: 7 Gasket: Yes Male/female: Male DIN norm: 72577 ISO norm: 1724
13 PIN			
180405 Trailer Cable Kit Servicing: HC-CARGO 180214			
<i>w/ rubber gasket.</i>			
	Voltage: 12	Length: 1.8 m	Cable type: Multi core Socket: 13 Fixing materials: Yes Gasket: Yes DIN norm: 72570 ISO norm: 4091
TRAILER COILS 12 V			
13 PIN			
181600 Trailer coil w/ 2x13 pin plugs			
<i>Max extension length: 4.5 m.</i>			
	Voltage: 12	Working length: 3 m	Windings: 17 Plug 1: 13 Plug 2: 13 ISO norm: 11446
7 PIN			
180225 Trailer Coil			
	Voltage: 12	Cable dim.: 6x1+1x1.5 mm ² Working length: 3.5 m	Plug type: 12N, 24N, Europe Colour: Black Material: Polyurethan Windings: 42 Plug 1: 7 Plug 2: 7 ISO norm: 1724
180372 Trailer Coil			
	Voltage: 12	Cable dim.: 6x1+1x1.5 mm ² Working length: 3.5 m	Plug type: 12N, 12N Colour: Black Material: Polyurethan Windings: 42 Plug 1: 7 Plug 2: 7 ISO norm: 1724
180613 Trailer Coil			
	Voltage: 12	Cable dim.: 6x1+1x1.5 mm ² Working length: 1.5 m	Plug type: 12N, 12N Colour: Black Material: Polyurethan Windings: 15 Plug 1: 7 Plug 2: 7 ISO norm: 1724

181544 Extension Cable Coil

Voltage: 12

 Cable dim.:
6x1.5+1x2 mm²
Mount.: Screw
Working length: 3.5 m

 Plug type: 12N, Europe, 12N, Europe
Colour: Black
Material: Shock thermo plastic
Windings: 42
Plug 1: 7
Plug 2: 7
DIN norm: 72577
ISO norm: 1724

TRAILER COILS 24 V
2 PIN
181489 Trailer Coil

Voltage: 24

 Cable dim.: 2x35 mm²
Working length: 4 m

 Plug type: Nato plug
Colour: Red/black
Material: Polyurethan
Windings: 35
Plug 1: 2
Plug 2: 2

5 PIN
180247 ABS Trailer Coil

Voltage: 24

 Cable dim.:
2x4+3x1.5 mm²
Working length: 4 m

 Plug type: ABS
Material: Polyurethan
Plug 1: 5
Plug 2: 5
DIN norm: 74001
ISO norm: 7638

7 PIN
180194 Trailer Coil

Voltage: 24

 Cable dim.:
6x1+1x1.5 mm²
Working length: 3.5 m

 Plug type: 12N, 24N, Europe
Colour: Black
Material: Nylon
Windings: 20
Plug 1: 7
Plug 2: 7
ISO norm: 1185
ISO norm 2: 1724

180195 Trailer Coil

Aluminium plug.



Voltage: 24

 Cable dim.:
6x1+1x1.5 mm²
Working length: 3.5 m

 Plug type: 24N, Europe
Colour: Black
Material: Nylon
Windings: 20
Plug 1: 7
Plug 2: 7
DIN norm: 72579
ISO norm: 1185

180196 Trailer Coil

Voltage: 24

 Cable dim.:
6x1+1x1.5 mm²
Working length: 3.5 m

 Plug type: 24N, Europe
Colour: Black
Material: Nylon
Windings: 20
Plug 1: 7
Plug 2: 7
DIN norm: 72579
ISO norm: 1185

	EL. SPECIFICATIONS	DIMENSIONS	ADDITIONAL SPECIFICATIONS
180226 Trailer Coil		Voltage: 24 Cable dim.: 6x1+1x1.5 mm ² Working length: 3.5 m	Plug type: 24N, Europe Colour: Black Material: Polyurethan Windings: 42 Plug 1: 7 Plug 2: 7 ISO norm: 1185
180227 Trailer Coil <i>Aluminium plug.</i>		Voltage: 24 Cable dim.: 6x1+1x1.5 mm ² Working length: 3.5 m	Plug type: 24N, Europe Colour: Black Material: Polyurethan Windings: 42 Plug 1: 7 Plug 2: 7 ISO norm: 1185
180228 Trailer Coil		Voltage: 24 Cable dim.: 6x1+1x1.5 mm ² Mount.: Moulded Working length: 3.5 m	Plug type: 24N, Europe Colour: Black Material: Polyurethan Windings: 42 Plug 1: 7 Plug 2: 7 ISO norm: 1185
180316 Trailer Coil		Voltage: 24 Cable dim.: 6x1+1x1.5 mm ² Working length: 3.5 m	Plug type: 24S, Europe Colour: Black Material: Polyurethan Windings: 42 Plug 1: 7 Plug 2: 7 ISO norm: 3731
180572 Trailer Coil		Voltage: 24 Cable dim.: 2x4+5x1.5 mm ² Working length: 4 m	Plug type: EBS Material: Polyurethan Plug 1: 7 Plug 2: 7 DIN norm: 74001 ISO norm: 7638
15 PIN			
180251 Trailer Coil		Voltage: 24 Cable dim.: 12x1.5+3x2.5 mm ² Working length: 3.5 m	Material: Polyurethan Plug 1: 15 Plug 2: 15 ISO norm: 4141 ISO norm 2: 6772 ISO norm 3: 12098 GGVS approval: Yes
ACCESSORIES			
180245 ABS Sealing Kit			Socket type: ABS No./poles: 7

	EL. SPECIFICATIONS	DIMENSIONS	ADDITIONAL SPECIFICATIONS
181581 Rubber Bushing <i>w/ 2 outlets.</i> 	Servicing: HC-CARGO 181547	OD: 6.5 mm	
181583 Mounting Bracket <i>For trailer socket.</i> 	Servicing: HC-CARGO 180110, 180218, 180239, 180293, 181485	ID: 40 mm OD: 80 mm Dist. mount. holes: 20 mm Mount hole: 12 mm	No./mounting holes: 2 (0)
181612 Rubber Gasket 	Servicing: HC-CARGO 180110, 180218, 180239, 180293, 181485		Colour: Black Material: EPDM rubber
181623 Cable w/ connector 2P 2m 	Servicing: HC-CARGO 181617 Voltage: 12	Cable dim.: 2x1 mm ² Length: 2 m	Plug type: 2 pin Power Seal Plug 1: 2
181624 Cable w/ connector 2P 3.56m 	Servicing: HC-CARGO 181617 Voltage: 12	Cable dim.: 2x1 mm ² Length: 3.56 m	Plug type: 2 pin Power Seal Plug 1: 2
181625 Cable w/ connector 4P 2.3 m 	Servicing: HC-CARGO 181617 Voltage: 12	Cable dim.: 4x1 mm ² Length: 2.3 m	Plug type: 4 pin Power Seal Plug 1: 4
181626 Cable w/ connector 4P 4.06 m 	Servicing: HC-CARGO 181617 Voltage: 12	Cable dim.: 4X1 mm ² Length: 4.06 m	Plug type: 4 pin Power Seal Plug 1: 4

	EL. SPECIFICATIONS	DIMENSIONS	ADDITIONAL SPECIFICATIONS
181627 Bayonet connector 	Servicing: HC-CARGO 181617 Voltage: 12	Cable dim.: 8x1.5-2.5 mm ² Mount.: Terminal	Locking device: Bayonet No./poles: 8 DIN norm: 72580
181628 Rubber Gasket 	Servicing: HC-CARGO 180110, 180218, 180239, 180293, 181485		Colour: Black Material: EPDM rubber
<h2>NATO CABLE CONNECTORS</h2>			
180197 Nato Socket <i>Terminal: HC-CARGO 180560.</i> 	Voltage: 24 Amp: 200	Dim.: 35-50 mm ² Dist. mount. holes: 82.5/47.6 mm Connection: Solder/crimp	No./mounting holes: 4 No./poles: 2 Male/female: Female Approvals: VG 96917
180198 Nato Plug 	Voltage: 24 Amp: 200	Dim.: 50 mm ² Connection: Solder/crimp	No./poles: 2 Male/female: Male Approvals: VG 96917
180325 Nato Plug <i>w/ screw device.</i> 	Voltage: 24 Amp: 200	Dim.: 50 mm ² Connection: Solder/crimp	Material: Metal/Rubber No./poles: 2 Male/female: Male
180349 Nato Socket 	Voltage: 24 Amp: 250	Dim.: 70 mm ² Dist. mount. holes: 85/60 mm Connection: 10 mm ring terminals	No./mounting holes: 4 No./poles: 2 Male/female: Female
180350 Nato Plug 	Voltage: 24 Amp: 250	Dim.: 70 mm ² Connection: Soldering	No./poles: 2 Male/female: Male

	EL. SPECIFICATIONS	DIMENSIONS	ADDITIONAL SPECIFICATIONS
181563 Nato Plug			
	Servicing: HC-CARGO 180197		
	Voltage: 24 Amp: 200	Dim.: 50 mm ² Connection: Solder/ crimp	No./poles: 2 Male/female: Male
181611 Nato Plug			
Terminal: HC-CARGO 180561.			
	Servicing: HC-CARGO 180197		
	Voltage: 24 Amp: 200	Dim.: 35 mm ² Connection: Solder/ crimp	Material: Aluminium No./poles: 2 Male/female: Male Approvals: VG 96917
181630 Nato Socket			
Terminal: HC-CARGO 180561.			
	Servicing: HC-CARGO 180198		
	Voltage: 24	Dim.: 35-50 mm ²	Colour: Yellow/black No./mounting holes: 4 No./poles: 2 Male/female: Female Approvals: VG 96917
193002 Nato Socket 2-pin			
Terminal: HC-CARGO 180561.			
	Servicing: HC-CARGO 180198		
	Voltage: 24	Dim.: 35 mm ² ID/mount. hole: 6 mm Dist. mount. holes: 82x49 mm Connection: Soldering	Colour: Black Material: Plastic No./mounting holes: 4 No./poles: 2 Cap: w/ Male/female: Female Approvals: VG 96917
SPARE PARTS			
180560 Terminal			
Long.			
	Servicing: HC-CARGO 180197, 181630		
		Plug length: 67.2 mm Cable size: 35-50 mm ²	Male/female: Female
180561 Terminal			
Servicing: HC-CARGO 181611			
	Servicing: HC-CARGO 181611		
		Plug length: 42 mm Cable size: 35 mm ²	Male/female: Male
ACCESSORIES			
180199 Nato Coupling			
	Servicing: HC-CARGO 180197, 181630		
	Voltage: 24 Amp: 200	Dim.: 35-50 mm ²	No./poles: 2 Approvals: VG 96917

Contact allocation for 7 - 13 and 14 - Pin Sockets

7-PIN plugs / sockets 12 V ISO 1724, DIN 72577 (12N)

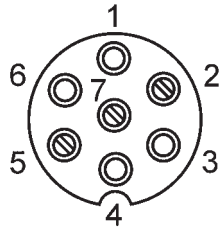

- 1/L) Left-hand direction indicator lamp.
- 2/54G) Rear fog lamp.
- 3/31) Common return.
- 4/R) Right-hand direction indicator lamp.
- 5/58L) Right-hand rear position and end-outline marker lamp, and rear-registration plate illumination device. 1)
- 6/54) Stop lamp.
- 7/58L) Left-hand rear position and end-outline marker lamp, and rear-registration plate illumination device. 1)

1) The rear registration plate illumination device shall be connected in such a manner that no lamp of such a device has a common connection with both contacts 5 and 7.

7-PIN plugs / sockets 12 V ISO 3732 (12S)

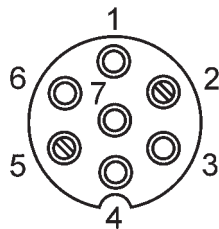

- 1/L) R Reversing lamp. 2)
- 2/54G) Coding for coupled trailer (within the plug pin no. 2 shall be connected to pin no. 3 to signal to the towing vehicle when a trailer is connected).
- 3/31) Common return (for contact no. 4-5).
- 4/R) Continuous power supply.
- 5/58L) Sensing device.
- 6/54) Power supply (controlled by ignition switch).
- 7/58L) Common return (for contact no. 6).

2) The common return for the circuit of this contact will normally be by contact no. 3/31 of the 12N connector according to ISO 1724.

7-PIN plugs / sockets 24 V ISO 1185, DIN 72579 (24N)

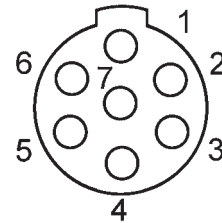

- 1/31) Common return.
- 2/58L) Left-hand rear position and end-outline marker lamp, and rear-registration plate illumination device. 3)
- 3/L) Left-hand direction indicator lamp.
- 4/54) Stop lamp.
- 5/R) Right-hand direction indicator lamp.
- 6/58R) Right-hand rear position and end-outline marker lamp, and rear-registration plate illumination device. 3)
- 7/54G) Braking control for trailers.

3) The rear registration plate illumination device shall be connected in such a manner that no lamp of such a device has a common connection with both contacts 2 and 6.

7-PIN plugs / sockets 24 V ISO 3731 (24S)

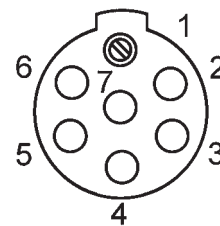

- 1/31) Common return.
- 2/58L) No allocation.
- 3/L) Reversing lamp.
- 4/54) Continuous power supply.
- 5/R) Control via common return.
- 6/58R) Power supply (controlled by ignition switch).
- 7/54G) Rear fog lamp.

13-PIN plugs / sockets
ISO 11446, DIN 72570
and 13-PIN Multicon

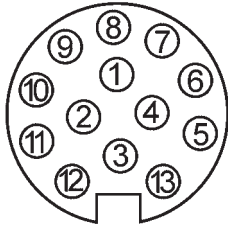

- 1) Left-hand direction indicator lamp.
- 2) Rear fog lamp.
- 3) Common return for contacts nos. 1 to 8. 1)
- 4) Right-hand direction indicator lamp.
- 5) Right-hand rear position and end-outline marker lamp, and rear-registration plate illumination device. 2)
- 6) Stop lamp.
- 7) Left-hand rear position and end-outline marker lamp, and rear-registration plate illumination device. 2)
- 8) Reversing lamp.
- 9) Continuous power supply.
- 10) Power supply (controlled by ignition switch).
- 11) Earth (for contact no. 10). 1)
- 12) Coding for coupled trailer (on the plug, pin no. 12 shall be bridged to pin no. 3 to return to the towing vehicle the information whether a trailer is coupled or not).
- 13) Common return (for contact no. 9). 1)

1) The three common return circuits shall not be connected electrically in the trailer.
2) The rear registration plate illumination device shall be connected such that no lamp of the device has a common connection with either contact 5 or 7.

VBG contact14

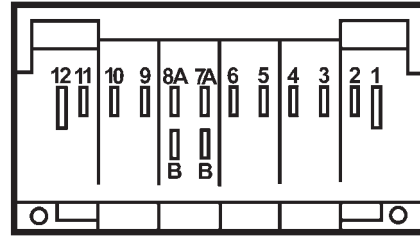

- 1) Common return.
- 2) Left hand direction indicator lamp.
- 3) Right hand direction indicator lamp.
- 4) Stop lamp.
- 5) Left-hand rear position and end-outline marker lamp, and rear-registration plate illumination device.
- 6) Right-hand rear position and end-outline marker lamp, and rear-registration plate illumination device.
- 7) a) Reversing b) Rear fog lamp. lamp.
- 8) a) b)
- 9)
- 10)
- 11)
- 12) Charging current.

Contact Allocation for ABS, EBS and ADR Connections

ABS / Plugs & Sockets ISO 7638

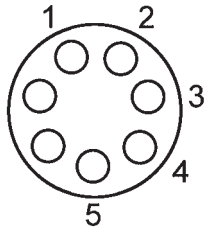

Contact allocation w/ electrical features

- | | | |
|----|------------------------------|-----------------------|
| 1) | Pos. (+) of solenoid valve | 4/6 mm ² . |
| 2) | Pos. (+) of electronic valve | 1.5 mm ² . |
| 3) | Neg. (-) of electronic valve | 1.5 mm ² . |
| 4) | Neg. (-) of solenoid valve | 4/6 mm ² . |
| 5) | Alarm equipment | 1.5 mm ² . |

EBS / Plugs & Sockets ISO 7638

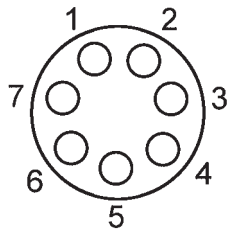

Contact allocation w/ electrical features

- | | | |
|----|---------------------------------|-----------------------|
| 1) | Pos. (+) of solenoid valve | 4/6 mm ² . |
| 2) | Pos. (+) of electronic valve | 1.5 mm ² . |
| 3) | Neg. (-) of electronic valve | 1.5 mm ² . |
| 4) | Neg. (-) of solenoid valve | 4/6 mm ² . |
| 5) | Alarm equipment | 1.5 mm ² . |
| 6) | Reserved for data communication | 1.5 mm ² . |
| 7) | Reserved for data communication | 1.5 mm ² . |

13-PINS and 15-PINS plugs/sockets DIN 40050 ISO 12098

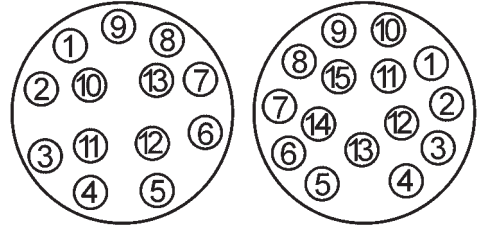

Contacts allocation

- 1) Left-hand direction indicator lamp.
- 2) Right-hand direction indicator lamp.
- 3) Rear fog lamp.
- 4) Common return.
- 5) Left-hand rear position and end-outline marker lamp, and rear registration plate illumination device. 1)
- 6) Right-hand rear position and end-outline marker lamp, and rear registration plate illumination device. 1)
- 7) Stop lamp.
- 8) Reversing lamp.
- 9) Power supply (+24V).
- 10) Worn brake lining sensor.
- 11) Pressure sensor for brakes.
- 12) Axle lifting device.
- 13) Common return for contacts 14 and 15.
- 14) Reserved for data communication. 2)
- 15) Reserved for data communication. 2)

1) The rear registration plate illumination shall be connected in such a manner that no lamp device has a common connection with both contacts 5 and 6.

2) Contacts 14 and 15, which are not used at present, shall be blanked to accept later fitment of pins and sleeves for data transmission functions, which are being designed. These blanks shall permit 13-pole version to mate with 15-pole versions

FUSES

TORPEDO

	HC-CARGO	Ampere	Voltage	Dim.
	190276	5	36	25x6 mm
	190277	8	36	25x6 mm
	190278	16	36	25x6 mm
	190279	25	36	25x6 mm
	190280	40	36	25x6 mm

CAR RADIO FUSES

	HC-CARGO	Ampere	Voltage	Dim.
	190285	0.5	250	20x5 mm
	192721	1	250	20x5 mm
	190286	2	250	20x5 mm
	190284	6.3	250	20x5 mm
	190734	10	250	20x5 mm
	191534	20	12/24	20x5 mm

GLASS

29X6.3 MM

	HC-CARGO	Ampere	Dim.
	190735	10	29x6.3 mm
	191570	15	29x6.3 mm
	191571	20	29x6.3 mm
	190736	25	29x6.3 mm
	191572	30	29x6.3 mm

32X6.3 MM

	HC-CARGO	Ampere	Voltage	Dim.
	190287	5	32	32x6.3 mm
	190288	10	32	32x6.3 mm
	190289	15	32	32x6.3 mm
	190274	20	32	32x6.3 mm
	190275	35	32	32x6.3 mm

MIDGET

KLK

Replaces: Fluke 892583.

	HC-CARGO	Ampere	Voltage	Dim.
	191671	15	600	38x10.3 mm
	191904	10	600	38x10.3 mm

BLS

Replaces: Fluke 871207.

	HC-CARGO	Ampere	Voltage	Dim.
	191760	1	600	35x10.3 mm

FLO				
	HC-CARGO	Ampere	Voltage	Dim.
	192533	20	500	38x10.3 mm

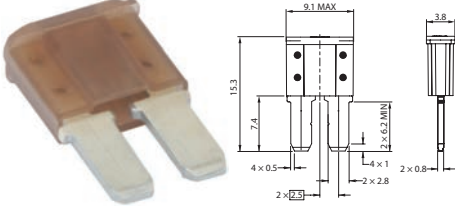
MICRO BLADE					
	HC-CARGO	Ampere	Voltage	Colour	Length
	193213	5	32	Tan	15.3 mm
	193214	7.5	32	Brown	15.3 mm
	193215	10	32	Red	15.3 mm
	193216	15	32	Blue	15.3 mm
	193217	20	32	Yellow	15.3 mm
	193218	25	32	Transparent	15.3 mm
	193219	30	32	Green	15.3 mm

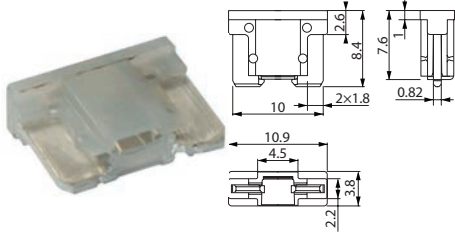
MINI BLADE LOW PROFILE					
	HC-CARGO	Ampere	Voltage	Colour	Length
	192762	2	58	Grey	10.9 mm
	192763	3	58	Purple	10.9 mm
	192764	4	58	Pink	10.9 mm
	192765	5	58	Tan	10.9 mm
	192766	7.5	58	Brown	10.9 mm
	192767	10	58	Red	10.9 mm
	192768	15	58	Blue	10.9 mm
	192769	20	58	Yellow	10.9 mm
	192770	25	58	Nature	10.9 mm
	192771	30	58	Green	10.9 mm

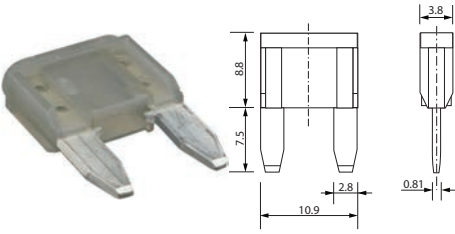
MINI BLADE					
	HC-CARGO	Ampere	Voltage	Colour	Length
	191465	2	32	Grey	16.3 mm
	191466	3	32	Purple	16.3 mm
	191467	4	32	Pink	16.3 mm
	191468	5	32	Tan	16.3 mm
	191469	7.5	32	Brown	16.3 mm
	191470	10	32	Red	16.3 mm
	191471	15	32	Blue	16.3 mm
	191472	20	32	Yellow	16.3 mm
	191473	25	32	Nature	16.3 mm
	191474	30	32	Green	16.3 mm

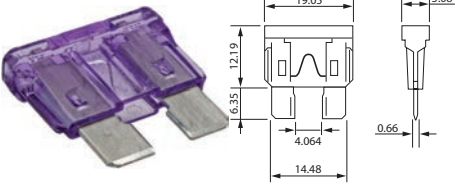
ATO BLADE					
	HC-CARGO	Ampere	Voltage	Colour	Length
	191475	1	32	Black	18.54 mm
	191476	2	32	Grey	18.54 mm
	190053	3	32	Purple	18.54 mm
	190054	4	32	Pink	18.54 mm
	190055	5	32	Tan	18.54 mm
	190056	7.5	32	Brown	18.54 mm
	190057	10	32	Red	18.54 mm
	190058	15	32	Blue	18.54 mm
	190059	20	32	Yellow	18.54 mm
	190060	25	32	Nature	18.54 mm
	190061	30	32	Green	18.54 mm
	191664	40	32	Orange	18.54 mm
	192165	35	32	Dark blue	18.54 mm

MAXI BLADE

	HC-CARGO	Ampere	Voltage	Colour	Length
	191249	20	32	Yellow	34.29 mm
	191250	30	32	Green	34.29 mm
	191251	40	32	Orange	34.29 mm
	191252	50	32	Red	34.29 mm
	191253	60	32	Blue	34.29 mm
	191254	70	32	Beige	34.29 mm
	191255	80	32	Nature	34.29 mm
	191256	100	32	Purple	34.29 mm

MIDI

	HC-CARGO	Ampere	Voltage	Colour	Length
	192427	30	32	Orange	41 mm
	192428	40	32	Green	41 mm
	192429	50	32	Red	41 mm
	192430	60	32	Yellow	41 mm
	192431	70	32	Brown	41 mm
	192432	80	32	White	41 mm
	192433	100	32	Blue	41 mm
	192434	125	32	Pink	41 mm
	192435	150	32	White	41 mm
	192976	200	32	Purple	41 mm

MEGA

	HC-CARGO	Ampere	Voltage	Colour	Length
	192791	40	32	White	68.58 mm
	192792	60	32	White	68.58 mm
	192793	80	32	Red	68.58 mm
	192049	100	32	Yellow	68.58 mm
	192050	125	32	Green	68.58 mm
	192051	150	32	Red	68.58 mm
	192052	175	32	White	68.58 mm
	192053	200	32	Blue	68.58 mm
	192229	225	32	Brown	68.58 mm
	192230	250	32	Pink	68.58 mm
	192231	300	32	Blue/grey	68.58 mm
	192977	350	32	Green	68.58 mm
	192978	400	32	Purple	68.58 mm
	192979	450	32	Yellow	68.58 mm
	192980	500	32	Brown	68.58 mm

HSB

	HC-CARGO	Ampere	Voltage	Dim.
	192798	30	32	42x12 mm
	192799	40	32	42x12 mm
	192800	50	32	42x12 mm
	192801	60	32	42x12 mm
	192802	80	32	42x12 mm
	192803	110	32	42x12 mm
	192804	150	32	42x12 mm
	192805	175	32	42x12 mm

PAL 293

	HC-CARGO	Ampere	Voltage	Colour	Length
	191152	30	32	Pink	30.6 mm
	191153	40	32	Green	30.6 mm
	191154	60	32	Yellow	30.6 mm
	191638	20	32	Blue	30.6 mm
	191970	50	32	Red	30.6 mm

PAL 2935						
	HC-CARGO	Ampere	Voltage	Colour	Length	
	191830	25	32	Brown	31.8 mm	
	191831	30	32	Green	31.8 mm	
	191832	45	32	Red	31.8 mm	
	191833	65	32	Black	31.8 mm	
	191834	75	32	Grey	31.8 mm	
PAL 2938						
	HC-CARGO	Ampere	Voltage	Colour	Length	
	191672	30	32	Pink	26.9 mm	
	191673	40	32	Green	26.9 mm	
PAL 294						
	HC-CARGO	Ampere	Voltage	Colour	Length	
	191155	30	32	Pink	42.8 mm	
	191973	40	32	Green	42.8 mm	
	191974	50	32	Red	42.8 mm	
	191156	60	32	Yellow	42.8 mm	
	191975	70	32	Brown	42.8 mm	
	191157	80	32	Black	42.8 mm	
	191971	100	32	Dark blue	42.8 mm	
	192760	120	32	White	42.8 mm	
PAL 295						
	HC-CARGO	Ampere	Voltage	Colour	Length	
	191628	30	32	Pink	63 mm	
	191629	40	32	Green	63 mm	
	191630	50	32	Red	63 mm	
	191631	60	32	Yellow	63 mm	
	191632	70	32	Brown	63 mm	
	191972	80	32	Black	63 mm	
	191977	100	32	Dark blue	63 mm	
	192982	120	32	White	63 mm	
	PAL 283					
	HC-CARGO	Ampere	Voltage	Colour	Length	
	191633	30	32	Pink	46 mm	
	191634	40	32	Green	46 mm	
	191635	50	32	Red	46 mm	
	191636	60	32	Yellow	46 mm	
	191637	70	32	Brown	46 mm	
	191976	80	32	Black	46 mm	
	191978	100	32	Dark blue	46 mm	
	192981	120	32	White	46 mm	
PAL JCASE						
	HC-CARGO	Ampere	Voltage	Colour	Length	
	192105	20	32	Blue	27 mm	
	192106	30	32	Pink	27 mm	
	192107	40	32	Green	27 mm	
	192108	50	32	Red	27 mm	
	192109	60	32	Yellow	27 mm	

PAL LOW PROFILE

	HC-CARGO	Ampere	Voltage	Colour	Length
	192779	20	58	Blue	16 mm
	192780	25	58	White	16 mm
	192781	30	58	Pink	16 mm
	192782	40	58	Green	16 mm
	192783	50	58	Red	16 mm
	192784	60	58	Yellow	16 mm

COMPACT

	HC-CARGO	Ampere	Voltage	Dim.	DIN norm	
	192538	50	58	20x23.5 mm	72581/3F	w/ ceramic body.
	192539	75	58	20x23.5 mm	72581/3F	w/ ceramic body.
	192540	100	58	20x23.5 mm	72581/3F	w/ ceramic body.
	192541	125	58	20x23.5 mm	72581/3F	w/ ceramic body.
	192542	150	58	20x23.5 mm	72581/3F	w/ ceramic body.
	192543	175	58	20x23.5 mm	72581/3F	w/ ceramic body.
	192544	200	58	20x23.5 mm	72581/3F	w/ ceramic body.
	192545	250	58	20x23.5 mm	72581/3F	w/ ceramic body.
	192546	300	58	20x23.5 mm	72581/3F	w/ ceramic body.

ACCESSORIES

192547 Battery Terminal

Servicing: Compact fuses - Visit www.hc-cargo.com for further information



Amp: 250

Polarity: Positive

No./connections: 1
Tin plated: Yes

192548 Battery Terminal

Servicing: Compact fuses - Visit www.hc-cargo.com for further information



Amp: 250

Polarity: Positive

No./connections: 2
Tin plated: Yes

192549 Nut

Servicing: Compact fuses - Visit www.hc-cargo.com for further information



Spanner size: 19 mm

STRIP

30 MM

	HC-CARGO	Ampere	Voltage	Length	Lever dim.	DIN norm	
	192705	25	36	41 mm	5.5 mm	72581/2	Small size
	191184	30	36	41 mm	5.5 mm	72581/2	Small size
	191185	40	36	41 mm	5.5 mm	72581/2	Small size
	191186	50	36	41 mm	5.5 mm	72581/2	Small size
	191187	60	36	41 mm	5.5 mm	72581/2	Small size
	191188	80	36	41 mm	5.5 mm	72581/2	Small size
	191189	100	36	41 mm	5.5 mm	72581/2	Small size
	192338	150	36	41 mm	5.5 mm	72581/2	Small size

60 MM							
9 MM							
	HC-CARGO	Ampere	Voltage	Length	Lever dim.	DIN norm	
	192298	50	36	82 mm	9 mm	43560	<i>Big size</i>
	192299	80	36	82 mm	9 mm	43560	<i>Big size</i>
	192300	100	36	82 mm	9 mm	43560	<i>Big size</i>
	192301	125	36	82 mm	9 mm	43560	<i>Big size</i>
	192302	160	36	82 mm	9 mm	43560	<i>Big size</i>
	192303	200	36	82 mm	9 mm	43560	<i>Big size</i>
	192304	250	36	82 mm	9 mm	43560	<i>Big size</i>
11 MM							
	HC-CARGO	Ampere	Voltage	Length	Lever dim.	DIN norm	
	192305	35	36	82 mm	11 mm	43560	<i>Big size</i>
	192306	50	36	82 mm	11 mm	43560	<i>Big size</i>
	192307	80	36	82 mm	11 mm	43560	<i>Big size</i>
	192308	100	36	82 mm	11 mm	43560	<i>Big size</i>
	192309	125	36	82 mm	11 mm	43560	<i>Big size</i>
	192310	160	36	82 mm	11 mm	43560	<i>Big size</i>
	192311	200	36	82 mm	11 mm	43560	<i>Big size</i>
	192312	250	36	82 mm	11 mm	43560	<i>Big size</i>
	192313	300	36	82 mm	11 mm	43560	<i>Big size</i>
	192314	355	36	82 mm	11 mm	43560	<i>Big size</i>
	192315	425	36	82 mm	11 mm	43560	<i>Big size</i>
	192316	500	36	82 mm	11 mm	43560	<i>Big size</i>
	60 MM, CLOSED TYPE						
9 MM							
	HC-CARGO	Ampere	Voltage	Length	Lever dim.	DIN norm	
	192317	35	80	82 mm	9 mm	43560	<i>Big size</i>
	192318	50	80	82 mm	9 mm	43560	<i>Big size</i>
	192319	80	80	82 mm	9 mm	43560	<i>Big size</i>
	192320	100	80	82 mm	9 mm	43560	<i>Big size</i>
	192321	125	80	82 mm	9 mm	43560	<i>Big size</i>
	192322	160	80	82 mm	9 mm	43560	<i>Big size</i>
	192323	200	80	82 mm	9 mm	43560	<i>Big size</i>
	192324	250	80	82 mm	9 mm	43560	<i>Big size</i>
11 MM							
	HC-CARGO	Ampere	Voltage	Length	Lever dim.	DIN norm	
	192325	35	80	82 mm	11 mm	43560	<i>Big size</i>
	192326	50	80	82 mm	11 mm	43560	<i>Big size</i>
	192327	80	80	82 mm	11 mm	43560	<i>Big size</i>
	192328	100	80	82 mm	11 mm	43560	<i>Big size</i>
	192329	125	36	82 mm	11 mm	43560	<i>Big size</i>
	192330	160	80	82 mm	11 mm	43560	<i>Big size</i>
	192331	200	80	82 mm	11 mm	43560	<i>Big size</i>
	192332	250	80	82 mm	11 mm	43560	<i>Big size</i>
	192333	275	80	82 mm	11 mm	43560	<i>Big size</i>
	192334	300	80	82 mm	11 mm	43560	<i>Big size</i>
	192335	355	80	82 mm	11 mm	43560	<i>Big size</i>
	192336	425	80	82 mm	11 mm	43560	<i>Big size</i>
	192337	500	80	82 mm	11 mm	43560	<i>Big size</i>
VARIOUS							
	HC-CARGO	Ampere	Voltage	Dim.			
	192861	10	250	31x6 mm			
	192862	10	250	25x6 mm			
	192863	20	250	25x6 mm	<i>For digital multimeter.</i>		

FUSE CARDS

TORPEDO TYPE

190002 Fuse Card

Content: 1x5 A, 4x8 A, 3x16 A, 1x25 A, 1x2 A.



Voltage: 32

Type: Torpedo

ATO BLADE TYPE

190004 Fuse Card

Contains: 1x3 A, 1x5 A, 1x7.5 A, 2x10 A, 1x15 A, 2x20 A, 1x25 A, 1x30 A.



Voltage: 32

Type: ATO

BOXES

TORPEDO TYPE

190768 Fuse Box

w/ 8 A fuse.



Type/fuse: Torpedo
 Plug type: Screw
 Bracket colour: Transparent
 Outlets: 2 way
 No./fuses: 2
 Fuses incl.: Yes

190770 Fuse Box

w/ 8 A fuse.



Type/fuse: Torpedo
 Plug type: Screw
 Bracket colour: Transparent
 Outlets: 4 way
 No./fuses: 4
 Fuses incl.: Yes

190772 Fuse Box

w/ 8 A fuse.



Type/fuse: Torpedo
 Plug type: Screw
 Bracket colour: Transparent
 Outlets: 6 way
 No./fuses: 6
 Fuses incl.: Yes

190774 Fuse Box

w/ 8 A fuse.



Type/fuse: Torpedo
 Plug type: Screw
 Bracket colour: Transparent
 Outlets: 8 way
 No./fuses: 8
 Fuses incl.: Yes

190775 Fuse Box

w/ 8 A fuse.

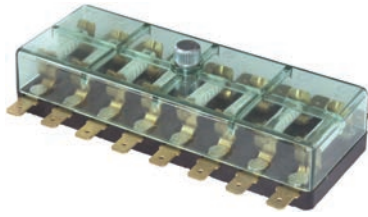

Type/fuse: Torpedo
 Plug type: Flat
 Bracket colour: Transparent
 Outlets: 8 way
 No./fuses: 8
 Fuses incl.: Yes

ATO BLADE TYPE
191161 Fuse Box

Type/fuse: ATO
 Plug type: Flat
 Bracket colour: Transparent
 Outlets: 4 way
 No./fuses: 4
 Fuses incl.: No

191162 Fuse Box

Type/fuse: ATO
 Plug type: Flat
 Bracket colour: Transparent
 Outlets: 6 way
 No./fuses: 6
 Fuses incl.: No

191163 Fuse Box

Type/fuse: ATO
 Plug type: Flat
 Bracket colour: Transparent
 Outlets: 8 way
 No./fuses: 8
 Fuses incl.: No

191164 Fuse Box

Type/fuse: ATO
 Plug type: Flat
 Bracket colour: Transparent
 Outlets: 4 way
 No./fuses: 4
 Fuses incl.: No

191165 Fuse Box

Type/fuse: ATO
 Plug type: Flat
 Bracket colour: Transparent
 Outlets: 6 way
 No./fuses: 6
 Fuses incl.: No

191409 Fuse Box

Kit set w/ cover, terminlas and terminal lock. Can be assembled in rows.



Type/fuse: ATO
 Plug type: Flat
 Bracket colour: Transparent
 Outlets: 16 way
 No./fuses: 16
 Fuses incl.: No

192057 Fuse Box

Servicing: Blade fuses up to 15 A - Visit www.hc-cargo.com for further information

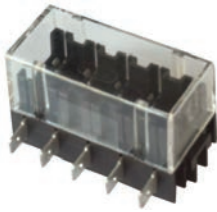

Type/fuse: ATO
 Plug type: Flat
 Bracket colour: Transparent
 Outlets: 5 way
 No./fuses: 5
 Fuses incl.: No

192058 Fuse Box

Servicing: Blade fuses up to 15 A - Visit www.hc-cargo.com for further information



Type/fuse: ATO
 Plug type: Flat
 Bracket colour: Transparent
 Outlets: 5 way
 No./fuses: 5
 Fuses incl.: No

192484 Fuse Box



Type/fuse: ATO
 Plug type: Flat
 Bracket colour: Transparent
 Outlets: 8 way
 No./fuses: 8
 Fuses incl.: No

192685 Fuse Box



Type/fuse: ATO
 Plug type: Flat
 Bracket colour: Transparent
 Outlets: 8 way
 No./fuses: 8
 Fuses incl.: No

192686 Multi Socket Set

Servicing: HC-CARGO 192685

For HC-CARGO 192685. w/ 4 multi plugs and 2 connectors in each.



Plug: Multiplug

HOLDERS

TORPEDO TYPE

190273 Fuse Holder



Amp/max: 8

Type/fuse: Torpedo
 Plug type: Screw

190787 Fuse Holder



Amp/max: 8

Type/fuse: Torpedo
 Plug type: Flat

191012 Fuse Holder

w/ 16 A fuse.

 Type/fuse: Torpedo
 Plug type: Screw

GLASS TYPE
190957 Fuse Holder

w/ 2 A radio fuse.

Amp/max: <2

 Type/fuse: Radio glass
 Cable incl.: Yes

192797 Fuse Holder

20x5 mm fuse and 32x6 mm fuse.

Amp/max: 17.5

 Type/fuse: Glass
 Cable incl.: Yes

MINI BLADE TYPE
191768 Fuse Holder

Amp/max: 20

 Cable dim. max: 2 mm²

 Type/fuse: Mini blade
 Material: Rubber
 Splash proof: Yes
 Cable incl.: Yes

191769 Fuse Holder

Amp/max: 30

 Cable dim. max: 3 mm²

 Type/fuse: Mini blade
 Material: Rubber
 Splash proof: Yes
 Cable incl.: Yes

ATO BLADE TYPE
190870 Fuse Holder

Scotch lock type.

 Cable dim. max: 2 mm²
 Cable dia. min: 0.8 mm²

 Type/fuse: ATO
 Colour: Blue

191001 Fuse Holder

Can be assembled in rows.

 Type/fuse: ATO
 Plug type: Flat

191054 Fuse Holder

Can be assembled in rows.



Type/fuse: ATO
Plug type: Flat

191640 Fuse Holder

Amp/max: 20

Cable dim. max: 1.3 mm²

Type/fuse: ATO
Material: Rubber
Splash proof: Yes
Cable incl.: Yes

191680 Fuse Holder

Amp/max: 30

Cable dim. max: 3.3 mm²

Type/fuse: ATO
Material: Rubber
Splash proof: Yes
Cable incl.: Yes

192631 Fuse Holder

w/ secondary lock. w/ cover and silicone gasket. Terminal: HC-CARGO 191870, 191871, 191872. Single wire seal: HC-CARGO 192647.



Amp/max: 5

Type/fuse: ATO
Colour: Nature
Splash proof: Yes
Holder incl.: No

192632 Fuse Holder

w/ secondary lock. w/ cover and silicone gasket. Terminal: HC-CARGO 191870, 191871, 191872. Single wire seal: HC-CARGO 192647.



Amp/max: 7.5

Type/fuse: ATO
Colour: Brown
Splash proof: Yes
Holder incl.: No

192633 Fuse Holder

w/ secondary lock. w/ cover and silicone gasket. Terminal: HC-CARGO 191870, 191871, 191872. Single wire seal: HC-CARGO 192647.



Amp/max: 10

Type/fuse: ATO
Colour: Red
Splash proof: Yes
Holder incl.: No

192634 Fuse Holder

w/ secondary lock. w/ cover and silicone gasket. Terminal: HC-CARGO 191870, 191871, 191872. Single wire seal: HC-CARGO 192647.



Amp/max: 15

Type/fuse: ATO
Colour: Blue
Splash proof: Yes
Holder incl.: No

EL. SPECIFICATIONS	DIMENSIONS	ADDITIONAL SPECIFICATIONS
<p>192635 Fuse Holder Servicing: Universal - Visit www.hc-cargo.com for further information <i>w/ secondary lock. w/ cover and silicone gasket. Terminal: HC-CARGO 191870, 191871, 191872. Single wire seal: HC-CARGO 192647.</i></p>		
	<p>Amp/max: 20</p>	<p>Type/fuse: ATO Colour: Yellow Splash proof: Yes Holder incl.: No</p>
<p>192636 Fuse Holder Servicing: Universal - Visit www.hc-cargo.com for further information <i>w/ secondary lock. w/ cover and silicone gasket. Terminal: HC-CARGO 191870, 191871, 191872. Single wire seal: HC-CARGO 192647.</i></p>		
	<p>Amp/max: 25</p>	<p>Type/fuse: ATO Colour: White Splash proof: Yes Holder incl.: No</p>
<p>192637 Fuse Holder Servicing: Universal - Visit www.hc-cargo.com for further information <i>w/ secondary lock. w/ cover and silicone gasket. Terminal: HC-CARGO 191870, 191871, 191872. Single wire seal: HC-CARGO 192647.</i></p>		
	<p>Amp/max: 30</p>	<p>Type/fuse: ATO Colour: Green Splash proof: Yes Holder incl.: No</p>
<p>192759 Fuse Holder Servicing: HC-CARGO 191411, 191412, 191413, 191870, 191871, 191872 <i>Can be assembled in rows. w/o terminals.</i></p>		
		<p>Type/fuse: ATO</p>
<p>191774 Fuse Holder Kit Servicing: HC-CARGO 191053, 191054, 191055 <i>Contains: 1x HC-CARGO 191053, 1x HC-CARGO 191054, 1x HC-CARGO 191055.</i></p>		
		
<p>192794 Fuse Holder Servicing: HC-CARGO 192986 <i>w/ mounting bracket. Can be built together w/ relay multi plug.</i></p>		
		<p>Type/fuse: ATO Plug type: Flat</p>

MAXI BLADE TYPE
191257 Maxi Blade Fuse Holder

To be assembled in rows. w/o terminals. Terminals: HC-CARGO 191260, 191261, 191262 (2 pcs).



Type/fuse: Maxi blade

191775 Maxi Blade Fuse Holder Kit

Contains: 1x HC-CARGO 191257, 1x HC-CARGO 191259, 1x HC-CARGO 191258, 2x HC-CARGO 191261.



Type/fuse: Maxi blade

192132 Maxi Blade Fuse Holder

To be assembled in rows. w/o terminals. w/ bracket. Terminals: HC-CARGO 192134, 192135 (2 pcs).



Amp/max: 80

Type/fuse: Maxi blade

192136 Maxi Blade Fuse Holder Kit

Contains: 1x HC-CARGO 192132, 192133, 2x HC-CARGO 192134, 191554, 190612.



Amp/max: 80

 Cable dim. max: 6 mm²
 Cable dia. min: 2.5 mm²

 Type: Set
 Type/fuse: Maxi blade

192137 Maxi Blade Fuse Holder Kit

Contains: 1x HC-CARGO 192132, 192133, 2x HC-CARGO 192135, 191554, 190612.



Amp/max: 80

 Cable dim. max: 10 mm²
 Cable dia. min: 5 mm²

 Type: Set
 Type/fuse: Maxi blade

192421 Maxi Blade Fuse Holder Kit

Contains: 1 splash/waterproof holder, 1 cover, 2 terminals for 4-6 mm cable (HC-CARGO 192486), 2 rubber wire seals.



Amp/max: 60

 Cable dim. max: 6 mm²
 Cable dia. min: 4 mm²

 Type/fuse: Maxi blade
 Splash proof: Yes
 Holder incl.: Yes
 Cable incl.: Yes

192422 Maxi Blade Fuse Holder Kit

Contains: 1 cover, 2 terminals for 6-10 mm cable, 2 rubber wire seals.



Amp/max: 60

Cable dim. max: 10 mm²
Cable dia. min: 6 mm²

Type: Set
Type/fuse: Maxi blade
Splash proof: Yes
Holder incl.: Yes
Cable incl.: Yes

192687 Maxi Blade Fuse Holder Kit

Contents: 1 splash waterproof holder, 1 cover, 2 terminals for 16 mm² cable and 2 wireseals.



193016 Fuse Holder



Amp/max: 60

Cable dia. min: 13 mm²

Type/fuse: Maxi
Colour: Black
Cable incl.: Yes

MIDI TYPE

192436 Fuse Holder



Amp/max: 200

Type/fuse: Midi

MEGA TYPE

192055 Mega Blade Fuse Holder

2 screws M8.

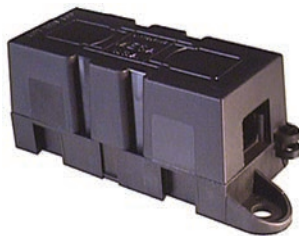

Amp/max: 250

Type/fuse: Mega
Plug type: Screw

192423 Mega Blade Fuse Holder

Servicing: HC-CARGO 192424

2 screws M8.



Amp/max: 250

Type/fuse: Mega
Splash proof: Yes

MICRO BLADE TYPE
192864 Fuse Holder

Amp/max: 10

 Type/fuse: Micro
 Colour: Black
 Material: Shockproof plastic
 Splash proof: Yes
 Cable incl.: Yes

JCASE TYPE
192952 Fuse Holder

Can be used together with JCase + JCase low profile fuses.

Amp/max: 60

 Type: Single
 Type/fuse: JCase
 Colour: Black
 Material: Rubber
 Splash proof: Yes
 Cable incl.: Yes

VARIOUS
191190 Fuse Holder

w/o fuse. w/ 2xM5 screws and washers.

Type/fuse: DIN 72581 strip

192344 Fuse Holder

2 screws M10. w/o fuse.

 Type: Single
 Type/fuse: DIN 43560 strip
 Plug type: Screw

192345 Fuse Holder

2 screws M10. w/o fuse.

 Type: Dual
 Type/fuse: DIN 43560 strip
 Plug type: Screw

ACCESSORIES
191053 Fixing Plate

Servicing: HC-CARGO 191054

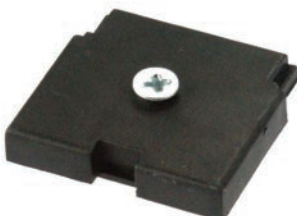

EL. SPECIFICATIONS	DIMENSIONS	ADDITIONAL SPECIFICATIONS
191055 Cover 	Servicing: HC-CARGO 191054	Material: Polycarbonate
191258 Cover 	Servicing: HC-CARGO 191257	
191259 Fixing Plate 	Servicing: HC-CARGO 191257	
192133 Cover 	Servicing: HC-CARGO 192132	
192424 Cover 	Servicing: HC-CARGO 192423	Type/fuse: Mega
192638 Fixing Plate 	Servicing: HC-CARGO 192631, 192637	
192639 Fixing Plate 	Servicing: HC-CARGO 192631, 192637	

ADAPTERS

192419 Fuse Adapter

For ATO blade fuse up to 10 A. Adapter for installation of extra fuse for accessories.

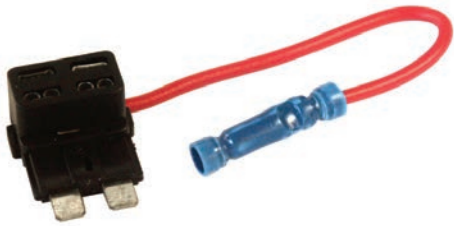

Voltage: 12
Amp: <10

Type: ATO
Terminals: 2

192420 Fuse Adapter

For Mini blade fuse up to 10 A. Adapter for installation of extra fuse for accessories. A safe and economical alternative to splicing.

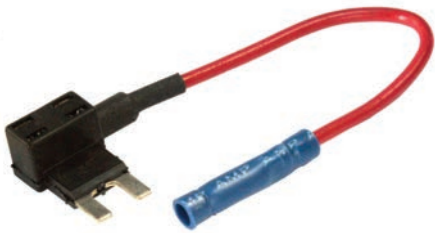

Voltage: 12
Amp: <10

Type: Mini blade
Terminals: 2

INDICATOR LIGHTS

180014 Indicator Light



Voltage: 12/24

Mount. hole size: 17 mm

Type/terminal: Screw
Socket type: BA9s
Colour: Blue
Material: Shockproof plastic
Bulb incl.: No
DIN norm: 72601

180015 Indicator Light



Voltage: 12/24

Mount. hole size: 17 mm

Type/terminal: Screw
Socket type: BA9s
Colour: Orange
Material: Shockproof plastic
Bulb incl.: No
DIN norm: 72601

180016 Indicator Light



Voltage: 12/24

Mount. hole size: 17 mm

Type/terminal: Screw
Socket type: BA9s
Colour: Green
Material: Shockproof plastic
Bulb incl.: No
DIN norm: 72601



180017 Indicator Light



Voltage: 12/24

Mount. hole size: 17 mm

Type/terminal: Screw
Socket type: BA9s
Colour: Red
Material: Shockproof plastic
Bulb incl.: No
DIN norm: 72601

	EL. SPECIFICATIONS	DIMENSIONS	ADDITIONAL SPECIFICATIONS
180343 Indicator Light 	Voltage: 12 Watt: 1.2	Terminal: 2.8 mm Mount. hole size: 10 mm	Type/terminal: Flat Colour: Orange Material: Shockproof plastic Terminals: 2 Bulb incl.: Yes
180344 Indicator Light Servicing: Renault, VW - Visit www.hc-cargo.com for further information			
	Voltage: 12 Watt: 1.2	Terminal: 2.8 mm Mount. hole size: 10 mm	Type/terminal: Flat Colour: Green Material: Shockproof plastic Terminals: 2 Bulb incl.: Yes
180345 Indicator Light 	Voltage: 12 Watt: 1.2	Terminal: 2.8 mm Mount. hole size: 10 mm	Type/terminal: Flat Colour: Red Material: Shockproof plastic Terminals: 2 Bulb incl.: Yes
180346 Indicator Light 	Voltage: 24 Watt: 1.2	Terminal: 2.8 mm Mount. hole size: 10 mm	Type/terminal: Flat Colour: Orange Material: Shockproof plastic Terminals: 2 Bulb incl.: Yes
180347 Indicator Light 	Voltage: 24 Watt: 1.2	Terminal: 2.8 mm Mount. hole size: 10 mm	Type/terminal: Flat Colour: Green Material: Shockproof plastic Terminals: 2 Bulb incl.: Yes
180348 Indicator Light 	Voltage: 24 Watt: 1.2	Terminal: 2.8 mm Mount. hole size: 10 mm	Type/terminal: Flat Colour: Red Material: Shockproof plastic Terminals: 2 Bulb incl.: Yes
LED			
181570 Indicator Light <i>EN60947-5-1, IEC947-5-1.</i>			
	Voltage: 24	Mount. hole size: 8 mm	Type/terminal: Solder Colour: Red Material: Nickel plated brass Bulb: LED

	EL. SPECIFICATIONS	DIMENSIONS	ADDITIONAL SPECIFICATIONS
181571 Indicator Light 	Voltage: 24	Mount. hole size: 8 mm	Type/terminal: Solder Colour: Green Material: Nickel plated brass Bulb: LED
181572 Indicator Light 	Voltage: 24	Mount. hole size: 8 mm	Type/terminal: Solder Colour: Yellow Material: Nickel plated brass Bulb: LED
181573 Indicator Light 	Voltage: 24	Mount. hole size: 8 mm	Type/terminal: Solder Colour: Blue Material: Nickel plated brass Bulb: LED
181574 Indicator Light 	Voltage: 24	Mount. hole size: 8 mm	Type/terminal: Solder Colour: White Material: Nickel plated brass Bulb: LED
181633 Indicator Light 	Voltage: 12	Mount. hole size: 8 mm	Type/terminal: Solder Colour: Red Material: Nickel plated brass Bulb: LED
181634 Indicator Light 	Voltage: 12	Mount. hole size: 8 mm	Type/terminal: Solder Colour: Green Material: Nickel plated brass Bulb: LED
181635 Indicator Light 	Voltage: 12	Mount. hole size: 8 mm	Type/terminal: Solder Colour: Yellow Material: Nickel plated brass Bulb: LED

181636 Indicator Light

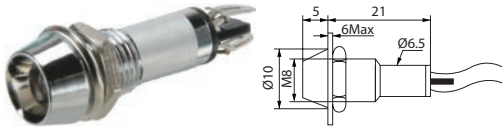

Voltage: 12

Mount. hole size: 8 mm

Type/terminal: Solder
Colour: Blue
Material: Nickel plated brass
Bulb: LED

181637 Indicator Light

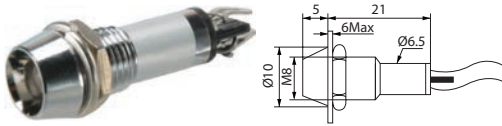

Voltage: 12

Mount. hole size: 8 mm

Type/terminal: Solder
Colour: White
Material: Nickel plated brass
Bulb: LED

CIRCUIT BREAKERS

ATO BLADE FUSE TYPE



HC-CARGO	Ampere	Voltage	Type	
192936	5	28	ATO	Manual reset.
192937	7.5	28	ATO	Manual reset.
192938	10	28	ATO	Manual reset.
192939	15	28	ATO	Manual reset.
192940	20	28	ATO	Manual reset.
192941	25	28	ATO	Manual reset.
192999	30	28	ATO	Manual reset.

MAXI BLADE FUSE TYPE

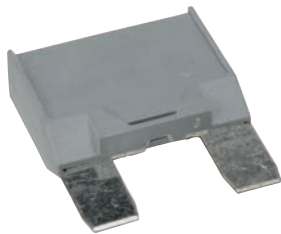

HC-CARGO	Ampere	Voltage	Type	
192942	10	28	Maxi blade	Manual reset.
192943	15	28	Maxi	Manual reset.
192944	20	28	Maxi	Manual reset.
192945	25	28	Maxi	Manual reset.
192947	35	28	Maxi	Manual reset.
192948	40	28	Maxi	Manual reset.
192949	50	28	Maxi	Manual reset.

PANEL MOUNT TYPE

192953 Circuit Breaker

Servicing: Motors, transformers, extra low voltage systems, household and office machines, instrumentation, marine applications

Switch/thermal circuit breaker w/ reset actuation mechanism. Designed for snap-in panel mounting utilising round hole or industry standard fuse holder cut dimension. AC 250 V, DC 28 V.



Voltage: Multi
Amp: 2.5

Length: 66 mm

Type: Panel mounted
Plug type: Flat

192954 Circuit Breaker

Servicing: Motors, transformers, extra low voltage systems, household and office machines, instrumentation, marine applications







Switch/thermal circuit breaker w/ reset actuation mechanism. Designed for snap-in panel mounting utilising round hole or industry standard fuse holder cut dimension. AC 250 V, DC 28 V.



Voltage: Multi
Amp: 5

Length: 66 mm

Type: Thermo contact
Plug type: Flat

	EL. SPECIFICATIONS	DIMENSIONS	ADDITIONAL SPECIFICATIONS
192955 Circuit Breaker Servicing: Motors, transformers, extra low voltage systems, household and office machines, instrumentation, marine applications <i>Switch/thermal circuit breaker w/ reset actuation mechanism. Designed for snap-in panel mounting utilising round hole or industry standard fuse holder cut dimension. AC 250 V, DC 28 V.</i>			
	Voltage: Multi Amp: 7	Length: 66 mm	Type: Thermo contact Plug type: Flat
192956 Circuit Breaker Servicing: Motors, transformers, extra low voltage systems, household and office machines, instrumentation, marine applications <i>Switch/thermal circuit breaker w/ reset actuation mechanism. Designed for snap-in panel mounting utilising round hole or industry standard fuse holder cut dimension. AC 250 V, DC 28 V.</i>			
	Voltage: Multi Amp: 10	Length: 66 mm	Type: Thermo contact Plug type: Flat
192957 Circuit Breaker Servicing: Motors, transformers, extra low voltage systems, household and office machines, instrumentation, marine applications <i>Switch/thermal circuit breaker w/ reset actuation mechanism. Designed for snap-in panel mounting utilising round hole or industry standard fuse holder cut dimension. AC 250 V, DC 28 V.</i>			
	Voltage: Multi Amp: 15	Length: 66 mm	Type: Thermo contact Plug type: Flat
192959 Circuit Breaker Servicing: Motors, transformers, battery chargers, machinery, extra low voltage systems <i>Circuit breaker w/ thread neck for panel mounting. Mounting hole 9.6 mm.</i>			
	Voltage: Multi Amp: 5	Length: 79.4 mm	Type: Thermo contact Plug type: Flat
192960 Circuit Breaker Servicing: Motors, transformers, battery chargers, machinery, extra low voltage systems <i>Circuit breaker w/ thread neck for panel mounting. Mounting hole 9.6 mm.</i>			
	Voltage: Multi Amp: 7	Length: 79.4 mm	Type: Thermo contact Plug type: Flat
192961 Circuit Breaker Servicing: Motors, transformers, battery chargers, machinery, extra low voltage systems <i>Circuit breaker w/ thread neck for panel mounting. Mounting hole 9.6 mm.</i>			
	Voltage: Multi Amp: 10	Length: 79.4 mm	Type: Thermo contact Plug type: Flat

	EL. SPECIFICATIONS	DIMENSIONS	ADDITIONAL SPECIFICATIONS
192962 Circuit Breaker			
Servicing: Motors, transformers, battery chargers, machinery, extra low voltage systems			
<i>Circuit breaker w/ thread neck for panel mounting. Mounting hole 9.6 mm.</i>			
	Voltage: Multi Amp: 15	Length: 79.4 mm	Type: Thermo contact Plug type: Flat
192963 Circuit Breaker			
Servicing: Motors, transformers, battery chargers, machinery, extra low voltage systems			
<i>Circuit breaker w/ thread neck for panel mounting. Mounting hole 9.6 mm.</i>			
	Voltage: Multi Amp: 20	Length: 79.4 mm	Type: Thermo contact Plug type: Flat
192964 Circuit Breaker			
Servicing: Motors, transformers, battery chargers, machinery, extra low voltage systems			
<i>Circuit breaker w/ thread neck for panel mounting. Mounting hole 9.6 mm.</i>			
	Voltage: Multi Amp: 25	Length: 79.4 mm	Type: Thermo contact Plug type: Flat
192966 Circuit Breaker			
Servicing: Motor protection, transformer protection, household appliances and office equipment, electrical tools, mobile homes			
<i>LED illuminated. Panel hole 36.8x21.1 mm. Optional rocker colour.</i>			
	Voltage: Multi Amp: 2.5		Type: Thermo contact Plug type: Flat Tightness norm: IP66
192967 Circuit Breaker			
Servicing: Motor protection, transformer protection, household appliances and office equipment, electrical tools, mobile homes			
<i>LED illuminated. Panel hole 36.8x21.1 mm. Optional rocker colour.</i>			
	Voltage: Multi Amp: 5		Type: Thermo contact Plug type: Flat Tightness norm: IP66
192968 Circuit Breaker			
Servicing: Motor protection, transformer protection, household appliances and office equipment, electrical tools, mobile homes			
<i>LED illuminated. Panel hole 36.8x21.1 mm. Optional rocker colour.</i>			
	Voltage: Multi Amp: 8		Type: Thermo contact Plug type: Flat Tightness norm: IP66

192969 Circuit Breaker

Servicing: Motor protection, transformer protection, household appliances and office equipment, electrical tools, mobile homes

LED illuminated. Panel hole 36.8x21.1 mm. Optional rocker colour.



Voltage: Multi
Amp: 10

Type: Thermo contact
Plug type: Flat
Tightness norm: IP66

192970 Circuit Breaker

Servicing: Motor protection, transformer protection, household appliances and office equipment, electrical tools, mobile homes

LED illuminated. Panel hole 36.8x21.1 mm. Optional rocker colour.



Voltage: Multi
Amp: 15

Type: Thermo contact
Plug type: Flat
Tightness norm: IP66

192971 Circuit Breaker

Servicing: Motor protection, transformer protection, household appliances and office equipment, electrical tools, mobile homes

LED illuminated. Panel hole 36.8x21.1 mm. Optional rocker colour.



Voltage: Multi
Amp: 20

Type: Thermo contact
Plug type: Flat
Tightness norm: IP66

ACCESSORIES

192958 Water Splash Cover

Servicing: HC-CARGO 192953, -192957



Colour: Transparent
Material: Rubber
Tightness norm: IP64

192965 Splash Proof Cover

Servicing: HC-CARGO 192959, 192964



Colour: Black

192972 Blue Cover

Servicing: HC-CARGO 192966, 192971

For circuit breaker.



Colour: Blue

192973 Black Cover

Servicing: HC-CARGO 192966, 192971

For circuit breaker.



Colour: Black

192974 Green Cover

Servicing: HC-CARGO 192966, 192971

For circuit breaker.



Colour: Green

RELAYS

DAYTIME RUNNING LIGHTS

160274AT Daytime Running Light

Servicing: Most european and japanese vehicles - Visit www.hc-cargo.com for further information

Complete w/ relays, wires and connecting material. Fitting instruction included.



Voltage: 12

160278 Relay

Special relay for automatic daytime running light (HC-CARGO 160274). To be used on vehicles w/ alternator w/o diodetro.

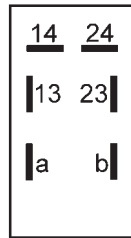
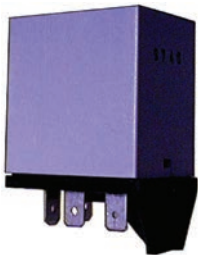

Voltage: 12

Terminals: 6

160904 Relay

Servicing: Opel, Opel, Vauxhall - Visit www.hc-cargo.com for further information

For day time running light.

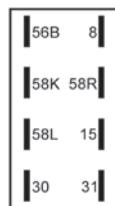

Voltage: 12

Terminals: 8

ACOUSTIC WARNING

160276 Warning Relay

Servicing: Nissan - Visit www.hc-cargo.com for further information

Light's on warning.



Voltage: 12
Decibel: 85

Terminals: 2

160347 Warning Relay

Voltage: 12
Decibel: 72

Type: Electronic
Terminals: 2

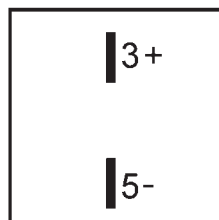

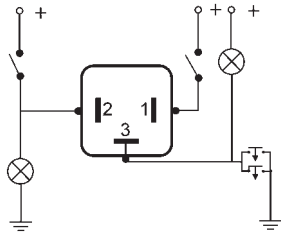
160509 Warning Relay

 Voltage: 12
 Decibel: Min 65

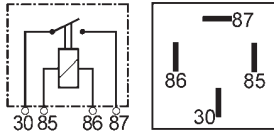
 Type: Electronic
 Terminals: 3

WORK RELAYS
MINI - 6 V
160652 Mini Relay

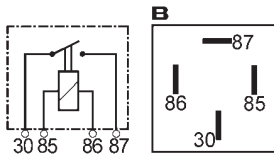
 Voltage: 6
 Amp: 20

 Terminals: 4
 Bracket: w/

MINI - 12 V
160080 Mini Relay

 Voltage: 12
 Amp: 30

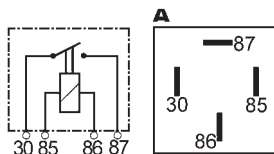
 Terminals: 4
 Bracket: w/

160083 Mini Relay

 Servicing: BMW - Visit www.hc-cargo.com for further information

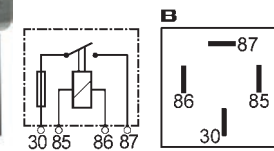
 Voltage: 12
 Amp: 30

 Terminals: 4
 Bracket: w/

160155 Mini Relay

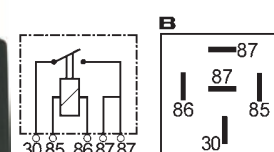
 Voltage: 12
 Amp: 30

 Type/fuse: ATO
 Terminals: 4
 Bracket: w/
 Fuses incl.: Yes

160265 Mini Relay

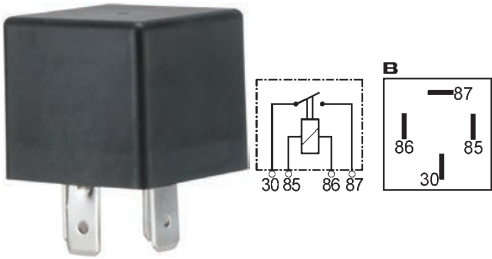
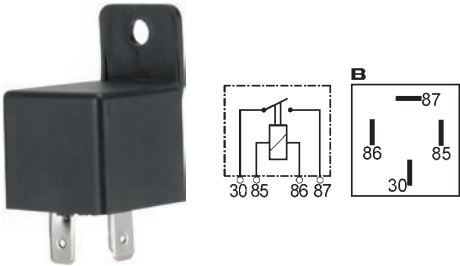
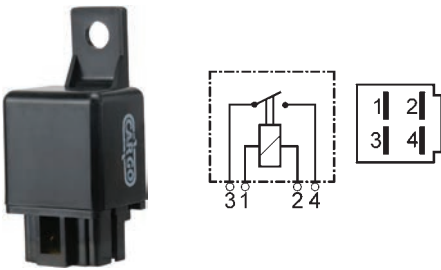
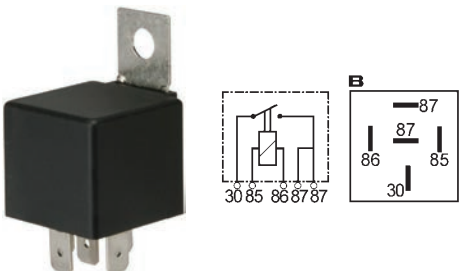
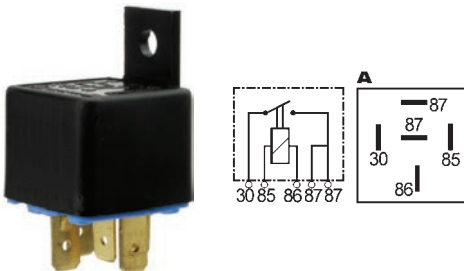
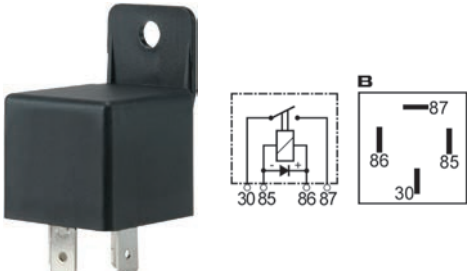
 Voltage: 12
 Amp: 40

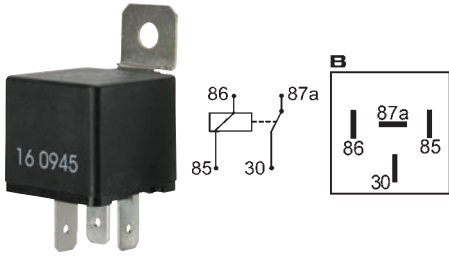
 Terminals: 5
 Bracket: w/

EL. SPECIFICATIONS	DIMENSIONS	ADDITIONAL SPECIFICATIONS
<p>160282 Mini Relay</p> 	<p>Servicing: 1403010, S115HD24-2, ZGS002, ZGS003, Kia</p> <p>Voltage: 12 Amp: 40</p>	<p>Terminals: 4 Bracket: w/o</p>
<p>160311 Mini Relay</p> 	<p>Voltage: 12 Amp: 40</p>	<p>Terminals: 4 Bracket: w/</p>
<p>160480 Mini Relay</p> 	<p>Voltage: 12 Amp: 30</p>	<p>Terminals: 4 Bracket: w/</p>
<p>160903 Mini Relay</p> 	<p>Voltage: 12 Amp: 40</p>	<p>Terminals: 5 Bracket: w/</p>
<p>160921 Mini Relay</p> 	<p>Voltage: 12 Amp: 40</p>	<p>Plug type: Flat Terminals: 5 Bracket: w/</p>
<p>160929 Mini Relay</p> 	<p>Voltage: 12 Amp: 40</p>	<p>Terminals: 4 Bracket: w/ Diode: w/</p>

160945 Mini Relay

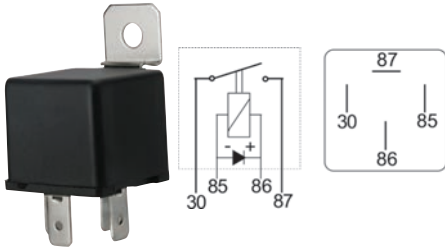
 Voltage: 12
Amp: 20

 Terminals: 4
Bracket: w/

160982 Mini Relay

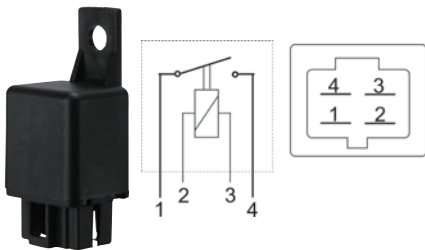
 Voltage: 12
Amp: 40

 Terminals: 4
Bracket: w/
Diode: w/

160983 Mini Relay

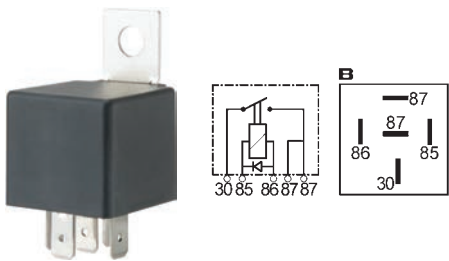
 Voltage: 12
Amp: 30

 Type: Japanese
Terminals: 4
Bracket: w/

161009 Mini Relay

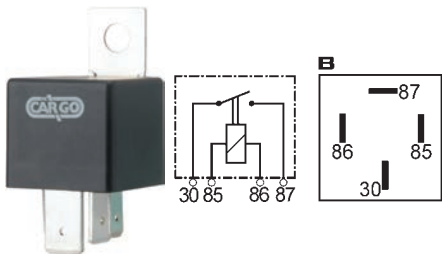
 Voltage: 12
Amp: 40

 Terminals: 5
Bracket: w/
Diode: w/

MINI - 12 V HIGH PERFORMANCE
160239 Mini Relay
w/ two 6.3 mm and two 9.5 mm terminals. (terminals 30 and 87).

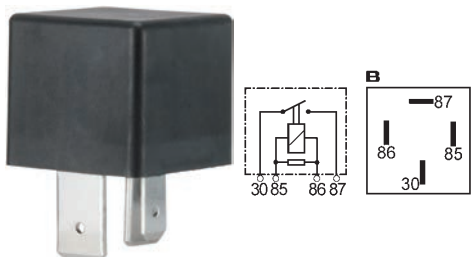
 Voltage: 12
Amp: 70

 Type: High performance
Terminals: 4
Bracket: w/

160468 Mini Relay
w/ two 6.3 mm and two 9.5 mm terminals. (terminals 30 and 87).

 Voltage: 12
Amp: 70

 Type: High performance
Terminals: 4
Resistor: w/
Bracket: w/o

160477 Mini Relay

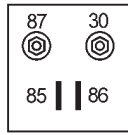
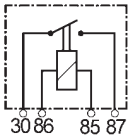
180 A for 15 sec. w/ 2x6.3 mm screws and 2xM6 flat plugs.



Voltage: 12
Amp: 100

Type: High performance
Terminals: 4
Bracket: w/

160477Z Mini Relay

180 A for 15 sec. w/ 2x6.3 mm screws and 2xM6 flat plugs.

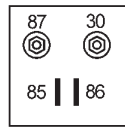
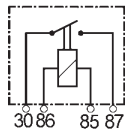

Voltage: 12
Amp: 100

Type: High performance
Terminals: 4
Bracket: w/

160720 Mini Relay

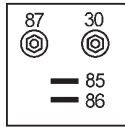
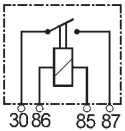

Voltage: 12
Amp: 120

Type: High performance
Terminals: 4
Bracket: w/

160922 Mini Relay

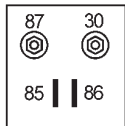
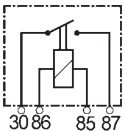

Voltage: 12
Amp: 140

Type: High performance
Terminals: 4
Bracket: w/

160923 Mini Relay

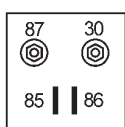
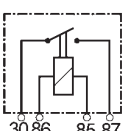

Voltage: 12
Amp: 200

Type: High performance
Terminals: 4
Bracket: w/

160931 Mini Relay

Terminal 85+86=6.3 mm. Terminal 87+30=8 mm.

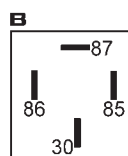
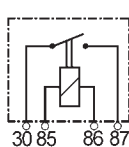

Voltage: 12
Amp: 50

Type: High performance
Terminals: 4
Bracket: w/

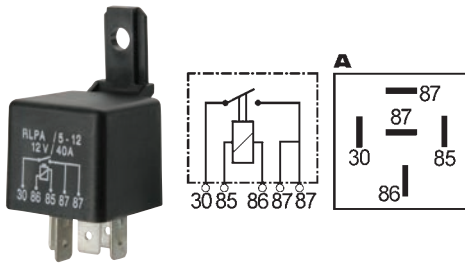
160940 Mini Relay
w/ double output.

 Voltage: 12
Amp: 40

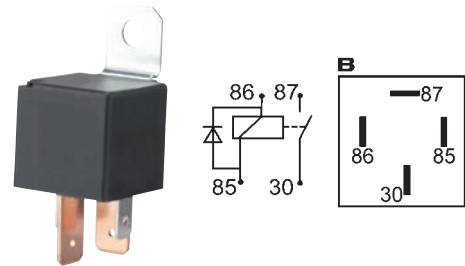
 Type: High performance
Terminals: 5
Bracket: w/

160941 Mini Relay

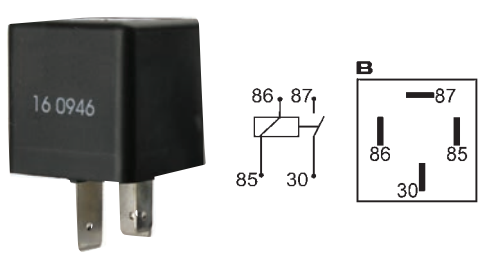
 Voltage: 12
Amp: 70

 Type: High performance
Terminals: 4
Bracket: w/
Diode: w/

160946 Mini Relay

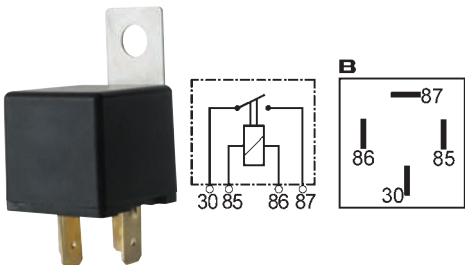
 Voltage: 12
Amp: 100

 Type: High performance
Terminals: 4
Bracket: w/o

MINI - 24 V
160082 Mini Relay

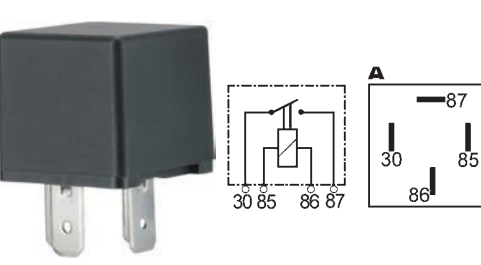
 Voltage: 24
Amp: 20

 Terminals: 4
Bracket: w/

160215 Mini Relay

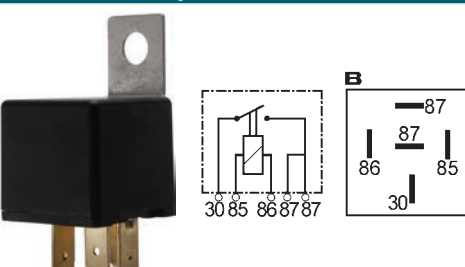
 Voltage: 24
Amp: 20

 Terminals: 4
Bracket: w/o

160266 Mini Relay

 Voltage: 24
Amp: 20

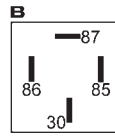
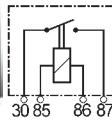
 Terminals: 5
Bracket: w/

160307 Mini Relay



Voltage: 24
Amp: 20

Terminals: 4
Bracket: w/o

160473 Mini Relay

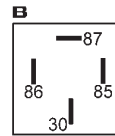
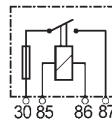

Voltage: 24
Amp: 30

Type/fuse: ATO
Terminals: 4
Bracket: w/
Fuses incl.: Yes

160890 Mini Relay

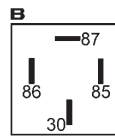
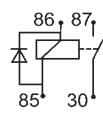

Voltage: 24
Amp: 20

Terminals: 4
Bracket: w/
Diode: w/

160926 Mini Relay

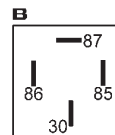
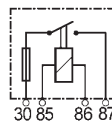

Voltage: 24
Amp: 15

Type/fuse: ATO
Terminals: 4
Bracket: w/
Fuses incl.: Yes

160935 Mini Relay

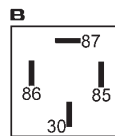
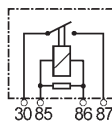

Voltage: 24
Amp: 22

Terminals: 4
Bracket: w/
Resistor: w/

160936 Mini Relay

w/ double output.

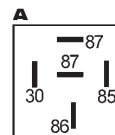

Voltage: 24
Amp: 22

Terminals: 5
Bracket: w/

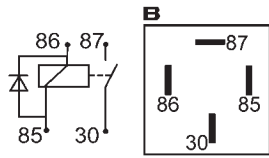
160947 Mini Relay

 Voltage: 24
 Amp: 30

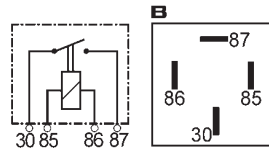
 Terminals: 4
 Bracket: w/
 Diode: w/

MINI - 24 V HIGH PERFORMANCE
160240 Mini Relay
w/ two 6.3 mm and two 9.5 mm terminals. (terminals 30 and 87).

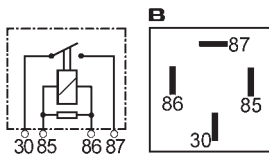
 Voltage: 24
 Amp: 40

 Type: High performance
 Terminals: 4
 Bracket: w/o

160272 Mini Relay
w/ two 6.3 mm and two 9.5 mm terminals. (terminals 30 and 87).

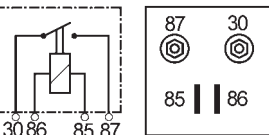
 Voltage: 24
 Amp: 70

 Type: High performance
 Terminals: 4
 Bracket: w/o
 Resistor: w/

160478 Mini Relay
180 A for 15 sec. w/ 2x6.3 mm screws and 2xM6 flat plugs.

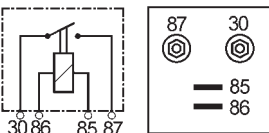
 Voltage: 24
 Amp: 60

 Type: High performance
 Terminals: 4
 Bracket: w/

160721 Mini Relay

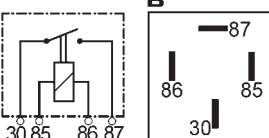
 Voltage: 24
 Amp: 100

 Type: High performance
 Terminals: 4
 Bracket: w/

160769 Mini Relay
w/ two 6.3 mm and two 9.5 mm terminals. (terminals 30 and 87).

 Voltage: 24
 Amp: 70

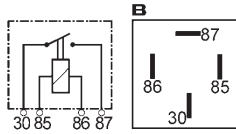
 Type: High performance
 Terminals: 4
 Bracket: w/o

160937 Mini Relay



Voltage: 24
Amp: 40

Type: High performance
Terminals: 4
Bracket: w/

160975 Mini Relay

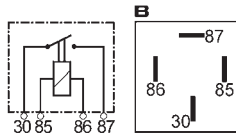

Voltage: 24
Amp: 70

Type: High performance
Terminals: 4
Bracket: w/

160977 Mini Relay

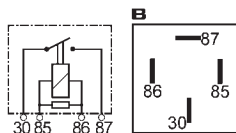

Voltage: 24
Amp: 50

Type: High performance
Terminals: 4
Bracket: w/
Resistor: w/

160978 Mini Relay

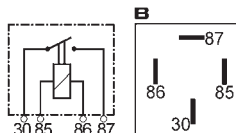

Voltage: 24
Amp: 40

Type: High performance
Terminals: 4
Bracket: w/o

160979 Mini Relay

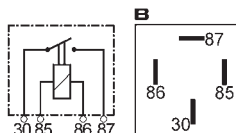

Voltage: 24
Amp: 30

Type: High performance
Terminals: 4
Bracket: w/

MICRO

160363 Micro Relay

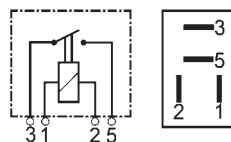

Voltage: 12
Amp: 30

Terminals: 4
Bracket: w/o

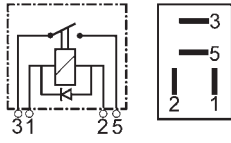
160364 Micro Relay

 Voltage: 12
 Amp: 25

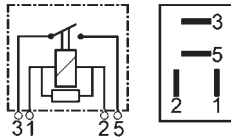
 Terminals: 4
 Bracket: w/o
 Diode: w/

160918 Micro Relay

 Voltage: 12
 Amp: 25

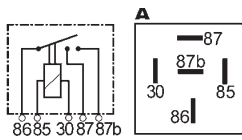
 Terminals: 4
 Bracket: w/o
 Resistor: w/

DOUBLE CONTACT
160168 Relay

 Servicing: Mercedes-Benz - Visit www.hc-cargo.com for further information

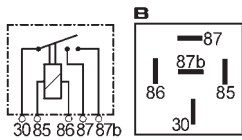
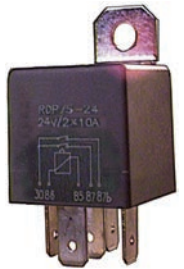
 Voltage: 12
 Amp: 2x20

 Terminals: 5
 Bracket: w/

160169 Relay

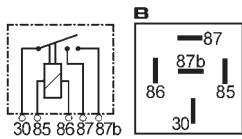
 Voltage: 24
 Amp: 2x10

 Terminals: 5
 Bracket: w/

160902 Relay

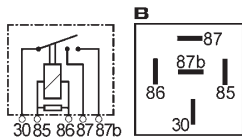
 Voltage: 12
 Amp: 2x15

 Terminals: 5
 Bracket: w/

160933 Mini Relay

 Voltage: 12
 Amp: 2x20

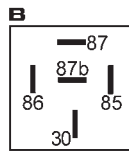
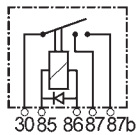
 Terminals: 5
 Bracket: w/
 Resistor: w/

160934 Mini Relay



Voltage: 12
Amp: 2x20

Terminals: 5
Bracket: w/
Diode: w/

160938 Relay

w/ double contact.

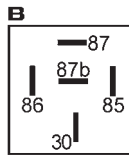
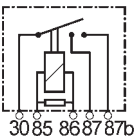

Voltage: 24
Amp: 2x10

Terminals: 5
Bracket: w/
Resistor: w/

160939 Relay

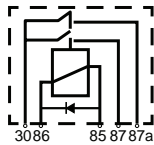
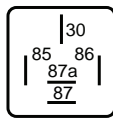

Voltage: 24
Amp: 2x10

Terminals: 5
Bracket: w/
Diode: w/

161011 Relay

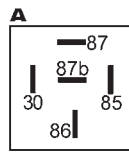
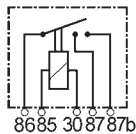

Voltage: 12
Amp: 2x20

Terminals: 5
Bracket: w/

161012 Relay

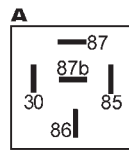
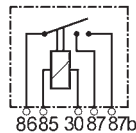

Voltage: 24
Amp: 2x10

Terminals: 5
Bracket: w/

TWIN

160267 Twin Relay

Servicing: VW - Visit www.hc-cargo.com for further information

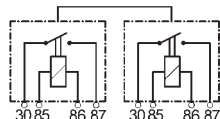
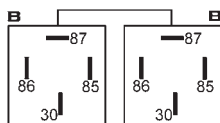

Voltage: 12
Amp: 2x40

Terminals: 2x4
Bracket: w/

HIGH PERFORMANCE 12 V
160984 Relay

 Voltage: 12
 Amp: 300

 Type: High performance
 Terminals: 3
 Bracket: w/

HIGH PERFORMANCE 24 V
160985 Relay

 Voltage: 24
 Amp: 200

 Type: High performance
 Terminals: 3
 Bracket: w/

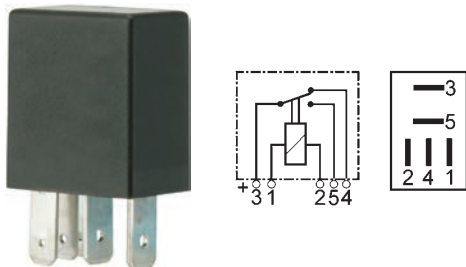
CHANGE OVER - 12 V
MICRO
160365 Micro Relay

 Voltage: 12
 Amp: 20/10

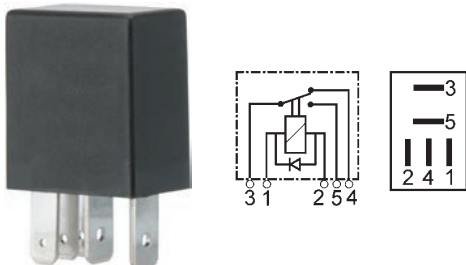
 Type: Change Over
 Terminals: 5
 Bracket: w/o

160366 Micro Relay

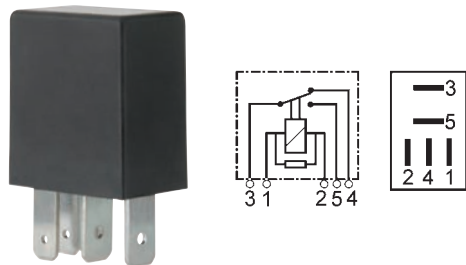
 Voltage: 12
 Amp: 15/25

 Type: Change Over
 Terminals: 5
 Bracket: w/o
 Diode: w/

160367 Micro Relay

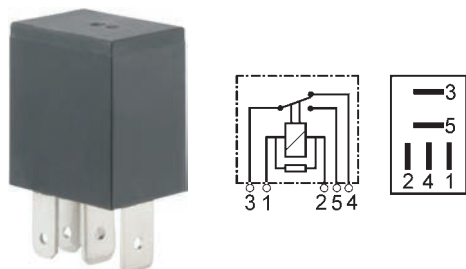
 Voltage: 12
 Amp: 15/25

 Type: Change Over
 Terminals: 5
 Bracket: w/o
 Resistor: w/

160919 Micro Relay

 Voltage: 12
 Amp: 20/10

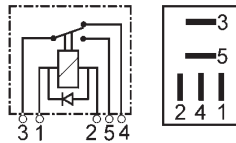
 Terminals: 5
 Bracket: w/o
 Resistor: w/

160920 Micro Relay



Voltage: 12
Amp: 20/10

Terminals: 5
Bracket: w/o
Diode: w/

160081 Relay

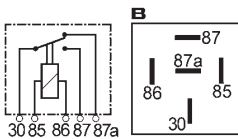

Voltage: 12
Amp: 20/30

Type: Change Over
Terminals: 5
Bracket: w/

160270 Relay

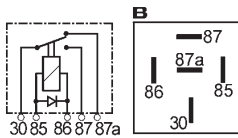

Voltage: 12
Amp: 20/30

Type: Change Over
Terminals: 5
Bracket: w/
Diode: w/

160308 Relay

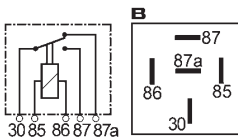

Voltage: 12
Amp: 40/15

Type: Change Over
Terminals: 5
Bracket: w/o

160316 Relay

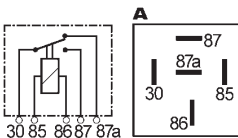

Voltage: 12
Amp: 40/15

Type: Change Over
Terminals: 5
Bracket: w/

160403 Relay

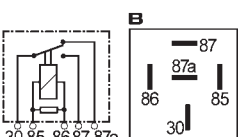

Voltage: 12
Amp: 20/30

Type: Change Over
Terminals: 5
Bracket: w/
Resistor: w/

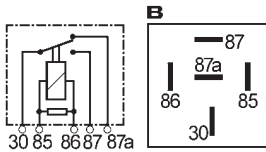
160932 Relay

 Voltage: 12
 Amp: 40/15

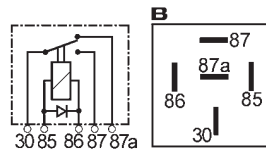
 Type: Change Over
 Terminals: 5
 Bracket: w/
 Resistor: w/

160942 Relay

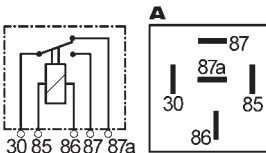
 Voltage: 12
 Amp: 40/15

 Type: Change Over
 Terminals: 5
 Bracket: w/
 Diode: w/

160974 Relay

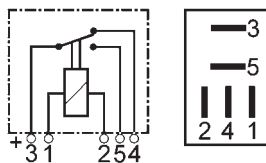
 Voltage: 12
 Amp: 40/70

 Type: Change Over
 Terminals: 5
 Bracket: w/

CHANGE OVER - 24 V
MICRO
160368 Micro Relay

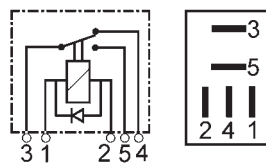
 Voltage: 24
 Amp: 5/10

 Type: Change Over
 Terminals: 5
 Bracket: w/o

160521 Micro Relay

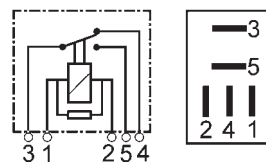
 Voltage: 24
 Amp: 5/10

 Type: Change Over
 Terminals: 5
 Bracket: w/o
 Diode: w/

161010 Micro Relay

 Voltage: 24
 Amp: 5/10

 Type: Change Over
 Terminals: 5
 Bracket: w/o
 Resistor: w/

 NEW PRODUCT
www.hc-cargo.com

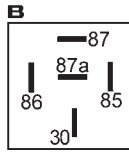
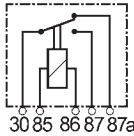
160216 Relay



Voltage: 24
Amp: 20/10

Type: Change Over
Terminals: 5
Bracket: w/

160271 Relay

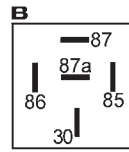
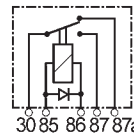

Voltage: 24
Amp: 20/10

Type: Change Over
Terminals: 5
Bracket: w/
Diode: w/

160317 Relay

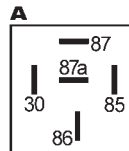
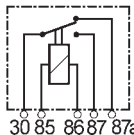

Voltage: 24
Amp: 20/10

Type: Change Over
Terminals: 5
Bracket: w/

160337 Relay

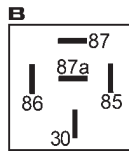
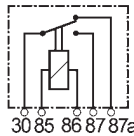

Voltage: 24
Amp: 10/22

Type: Change Over
Terminals: 5
Bracket: w/o

160394 Relay

Servicing: Mercedes, Iveco, Audi - Visit www.hc-cargo.com for further information

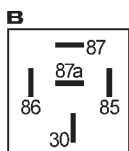
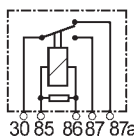

Voltage: 24
Amp: 40/60

Type: Change Over
Terminals: 5
Bracket: w/o
Resistor: w/

160944 Relay

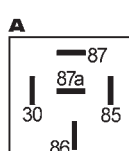
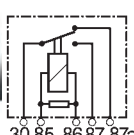

Voltage: 24
Amp: 10/20

Type: Change Over
Terminals: 5
Bracket: w/o
Resistor: w/

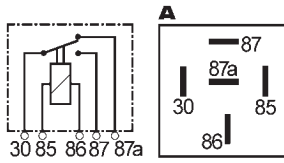
160976 Relay

 Voltage: 24
Amp: 30/50

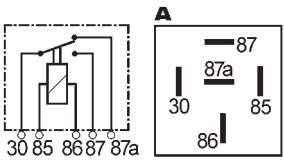
 Type: Change Over
Terminals: 5
Bracket: w/o

160980 Relay

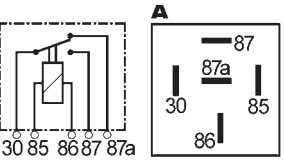
 Voltage: 24
Amp: 30/40

 Type: Change Over
Terminals: 5
Bracket: w/

160981 Relay

 Voltage: 24
Amp: 10/20

 Type: Change Over
Terminals: 5
Bracket: w/

FLIP FLOP
160654 Flip Flop Relay

 Servicing: Audi, VW - Visit www.hc-cargo.com for further information

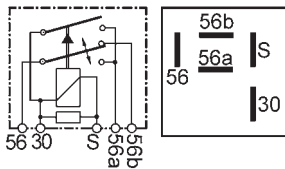
2 sec. on/off.



 Voltage: 12
Watt: 2x150

 Type: Flip Flop
Terminals: 5
Bracket: w/
Diode: w/

TIME DELAY - 12 V
160297 Time Delay Relay

 Servicing: Alfa Romeo, Opel, Audi, VW, Renault, Citroen, Peugeot, Volvo, Seat, Saab, Porsche, Skoda, Ford, Vauxhall, Alfa Romeo - Visit www.hc-cargo.com for further information

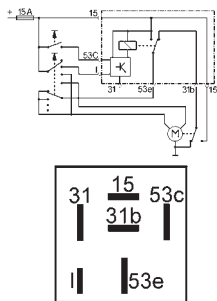
For windshield wiper and washer. Also for universal use.

 Voltage: 12
Amp: 15

Delay time: 3.5 sec.

 Terminals: 6
Bracket: w/o

160570 Relay Time Delay

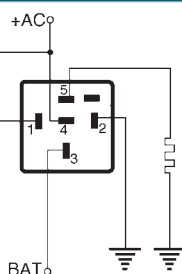
 Servicing: Universal - Visit www.hc-cargo.com for further information

 Voltage: 12
Amp: 20

Delay time: 10 min.

 Terminals: 5
Bracket: w/o

160749 Relay

Servicing: Audi, VW - Visit www.hc-cargo.com for further information

Washing/wiper unit w/ changeable intervals.

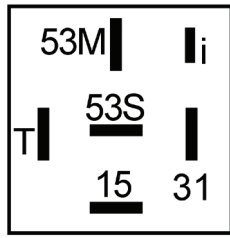

Voltage: 12
Amp: 30

Delay time: 0.5 sec

Terminals: 6
Bracket: w/o

160992 Time Delay Relay

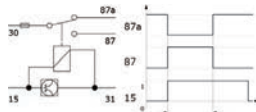

Voltage: 12
Amp: 20

Delay time: 3.5 sec

Type: Delay off
Terminals: 5
Bracket: w/

TIME DELAY - 24 V

160466 Time Delay Relay

For A/C compressor, bus doors and time delayed motors.

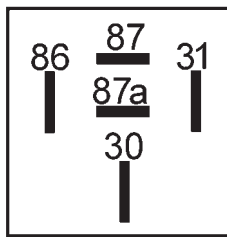

Voltage: 24
Amp: 5

Delay time: 4 sec

Terminals: 5
Bracket: w/o

MULTITIMER

160927 Multitimer Relay

0.5 sec. -6 hours.

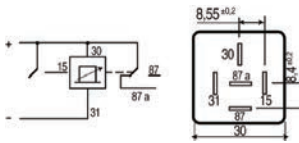

Voltage: 12
Amp: 10

Terminals: 5
Bracket: w/o

160928 Multitimer Relay

0.5 sec. -6 hours.

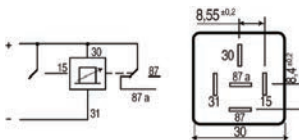

Voltage: 24
Amp: 10

Terminals: 5
Bracket: w/o

161008 Multitimer Relay

5 sec. - 10 hours.

 Voltage: 12
Amp: 10

 Terminals: 5
Bracket: w/o

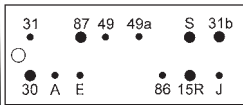
TIMING DEVICES
160287 Timing Device

 Voltage: 12
Watt: 2/4x21

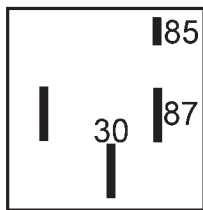
 Terminals: 12
Bracket: w/o

RADIATOR FANS
160637 Relay

 Voltage: 12
Amp: 30

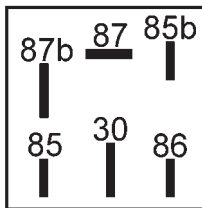
 Terminals: 4
Bracket: w/o

FUEL PUMPS
160295 Fuel Pump Relay

 Servicing: Opel, Vauxhall - Visit www.hc-cargo.com for further information

Voltage: 12

 Terminals: 6
Bracket: w/o

160348 Fuel Pump Relay

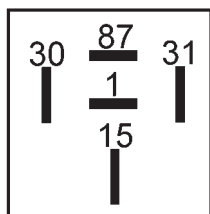
 Servicing: Ford - Visit www.hc-cargo.com for further information







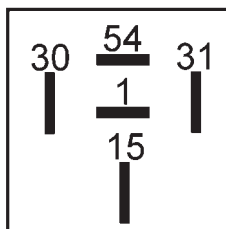



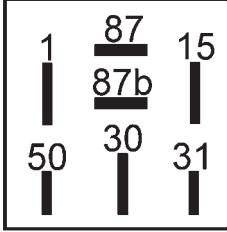

Voltage: 12

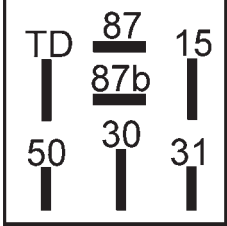
 Terminals: 5
Bracket: w/o

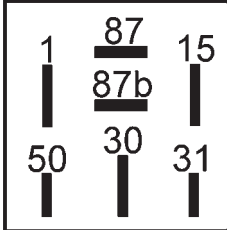
160350 Fuel Pump Relay

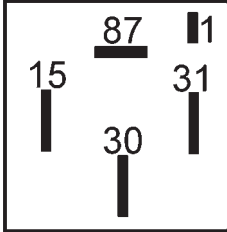
 Servicing: Ford - Visit www.hc-cargo.com for further information

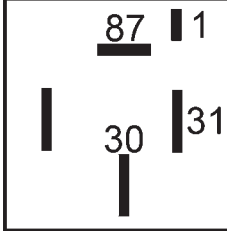
 Voltage: 12
Amp: 16

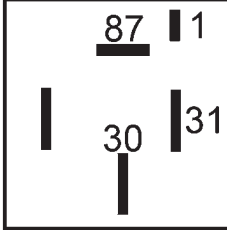
 Terminals: 5
Bracket: w/

EL. SPECIFICATIONS		DIMENSIONS	ADDITIONAL SPECIFICATIONS
160352 Fuel Pump Relay			
Servicing: BMW, Opel, Vauxhall, VW - Visit www.hc-cargo.com for further information			
		Voltage: 12	Terminals: 7 Bracket: w/
160353 Fuel Pump Relay			
Servicing: Alfa Romeo, Citroen, Ferrari, Fiat, Ford, Lancia, Peugeot, Seat - Visit www.hc-cargo.com for further information			
		Voltage: 12 Amp: 16	Terminals: 7 Bracket: w/
160354 Fuel Pump Relay			
Servicing: Alfa Romeo, Citroen, Fiat, Lancia, Opel, Peugeot, Renault, Vauxhall - Visit www.hc-cargo.com for further information			
		Voltage: 12 Amp: 16	Terminals: 7 Bracket: w/
160372 Fuel Pump Relay			
Servicing: Audi - Visit www.hc-cargo.com for further information			
		Voltage: 12	Terminals: 5 Bracket: w/o
160373 Fuel Pump Relay			
Servicing: Audi, VW - Visit www.hc-cargo.com for further information			
		Voltage: 12	RPM limited: 6600 Terminals: 5 Bracket: w/o
160374 Fuel Pump Relay			
Servicing: Audi, VW - Visit www.hc-cargo.com for further information			
		Voltage: 12	RPM limited: 6600 Terminals: 5 Bracket: w/o

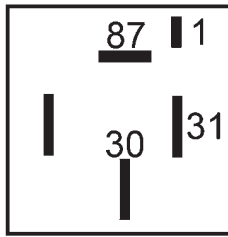
EL. SPECIFICATIONS
DIMENSIONS
ADDITIONAL SPECIFICATIONS
160375 Fuel Pump Relay

 Servicing: Audi, VW - Visit www.hc-cargo.com for further information

Voltage: 12

RPM limited: 6600

 Terminals: 5
Bracket: w/o

160400 Fuel Pump Relay

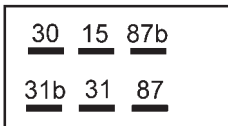
 Servicing: Volvo - Visit www.hc-cargo.com for further information

 Voltage: 12
Amp: 30

 Terminals: 6
Bracket: w/o

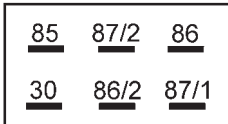
160401 Fuel Pump Relay

 Servicing: Volvo - Visit www.hc-cargo.com for further information

 Voltage: 12
Amp: 15

 Terminals: 6
Bracket: w/o

160470 Fuel Pump Relay

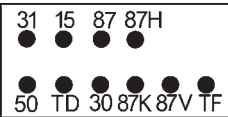
 Servicing: Mercedes-Benz - Visit www.hc-cargo.com for further information

Cold start valve.

Voltage: 12

RPM limited: 6200

 Terminals: 10
Bracket: w/o

160751 Fuel Pump Relay

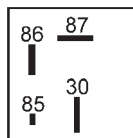
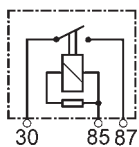
 Servicing: Audi, Seat, Skoda, VW - Visit www.hc-cargo.com for further information

 Voltage: 12
Amp: 30

 Terminals: 4
Bracket: w/o
Resistor: w/

160792 Fuel Pump Relay

 Servicing: Volvo - Visit www.hc-cargo.com for further information

Voltage: 12

 Terminals: 4
Bracket: w/o

MULTI PLUGS

190766 Relay Multiplug

Sockets can be built together. 5x6.3 mm flat plug terminals. 4x2.8 mm flat plug terminals.



Type: Socket
No./poles: 9
Plug: Female

190767 Relay Multiplug

6.3 mm.



Type: Socket
Type/terminal: Flat
No./poles: 5

191026 Relay Multiplug

Sockets can be built together. 2x9.5 mm flat plug terminals. 3x6.3 mm flat plug terminals. 4x2.8 mm flat plug terminals.



Type: Socket
No./poles: 9

191752 Relay Multiplug

Sockets can be built together. 2x6.3 mm flat plug terminals. 3x4.7 mm flat plug terminals.



Type: Socket
No./poles: 5

KITS

192158 Relay Multiplug Kit

Contents: 1x HC-CARGO 190766, 5x HC-CARGO 190252, 4x HC-CARGO 191083.



192159 Relay Multiplug Kit

Content: 1x HC-CARGO 190767, 5x HC-CARGO 190252.

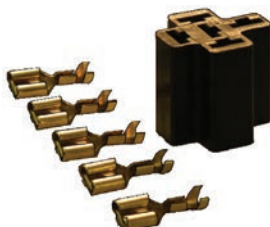

192160 Relay Multiplug Kit

Contents: 1x HC-CARGO 191026, 2x HC-CARGO 191025, 3x HC-CARGO190252, 4x HC-CARGO 191083.

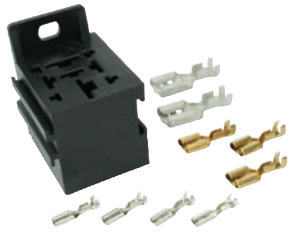
192161 Relay Multiplug Kit

Content: 1x HC-CARGO 191752, 2x HC-CARGO 190252, 3x HC-CARGO 191089.

BOXES
191410 Relay Box

Can be assembled in rows (terminals: HC-CARGO 190252 or 191029).



Capacity: 4
Assembling: Yes

Regulator type: Standard
Colour: Transparent
Terminals: w/
Lock: w/

191818 Relay Box

Can be assembled in rows (terminals: HC-CARGO 190252 or 191029).



Capacity: 7
Assembling: Yes

Regulator type: Micro
Colour: Transparent
Terminals: w/
Lock: w/

HAZARD WARNING LIGHT SYSTEM
160578 Hazard Warning Light

Complete set containing switch, relay and mounting bracket.

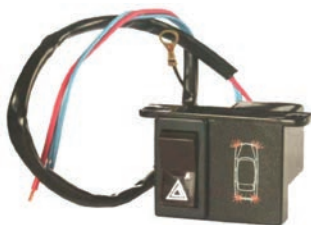

Voltage: 12

160924 Brake Hazard Relay

Activates hazard warning light when emergency braking.



Voltage: 12

Terminals: 5
Bracket: w/

160925 Brake Hazard Relay

Activates hazard warning light when emergency braking.

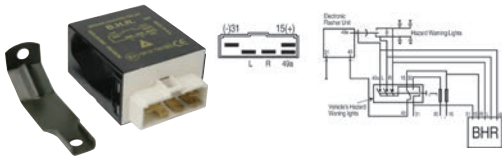

Voltage: 24

Terminals: 5
Bracket: w/

FLASHER UNITS - 6 V

160651 Flasher Unit

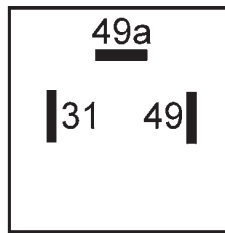

Voltage: 6
Watt: 42

Terminals: 3
Bracket: w/

FLASHER UNITS - 12 V

160115 Flasher Unit

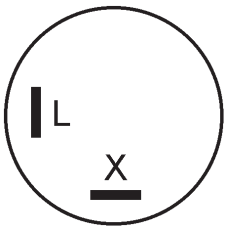

Voltage: 12
Watt: 138

Terminals: 2
Bracket: w/o

160116 Flasher Unit

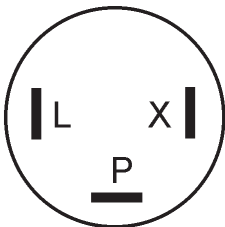

Voltage: 12
Watt: 138

Terminals: 3
Bracket: w/o

160242 Flasher Unit

Servicing: Alfa Romeo, Audi, Bedford, Ford, Nissan, Opel, Toyota - Visit www.hc-cargo.com for further information

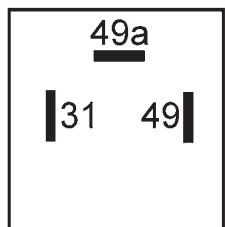

Voltage: 12
Watt: 2/4x21

Terminals: 3
Bracket: w/

160243 Flasher Unit

Servicing: Alfa Romeo, Audi, Austin, BMW, Citroen, Fiat, Ford, Honda, Iveco, Lada, Lancia, Mercedes-Benz, Opel, Peugeot, Porsche - Visit www.hc-cargo.com for further information

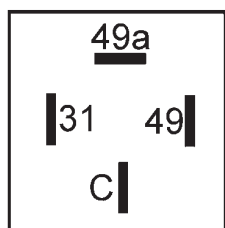

Voltage: 12
Watt: 2/4x21

Terminals: 4
Bracket: w/

160244 Flasher Unit

Servicing: Audi, Austin, BMW, Citroen, Daihatsu, Fiat, Ford, Honda, Lada, Lancia, Lexus, Mazda, Mercedes-Benz, Mitsubishi, Nissan - Visit www.hc-cargo.com for further information

For vehicles w/ towbars.

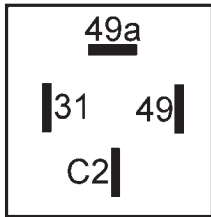

Voltage: 12
Watt: 2+1/6x21

Terminals: 4
Bracket: w/

160263 Flasher Unit

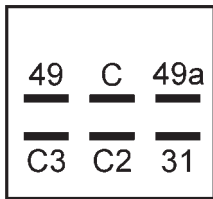

Voltage: 12
Watt: 2+1+1/8x21

Terminals: 6
Bracket: w/

160305 Flasher Unit

Servicing: Mercedes-Benz - Visit www.hc-cargo.com for further information

For vehicles w/ towbars.

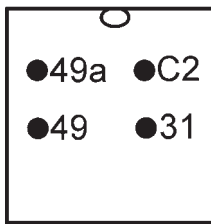

Voltage: 12
Watt: 2+1/6x21

Terminals: 4
Bracket: w/o

160312 Flasher Unit

Interchangeable w/ all 4 terminal device (+, -, C, R). for SAE standard vehicles (France, Italy, USA, Spain).

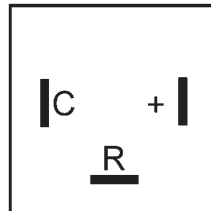

Voltage: 12
Watt: 2/4x21

Terminals: 3
Bracket: w/

160314 Flasher Unit

Servicing: Alfa Romero, Renault, Fiat, Lancia, Lada, Alfa Romeo, BMW, Fiat, Lada, Lancia, Renault - Visit www.hc-cargo.com for further information

For vehicles w/ towbars. For SAE standard vehicles (France, Italy, USA, Spain).

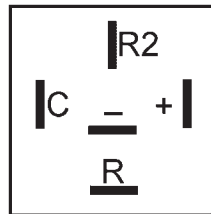

Voltage: 12
Watt: 2+1/6x21

Terminals: 5
Bracket: w/

160315 Flasher Unit

Servicing: Japanese vehicles - Visit www.hc-cargo.com for further information

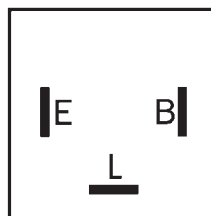

Voltage: 12
Watt: 2/4x21

Terminals: 3
Bracket: w/o

160318 Flasher Unit

Universal.

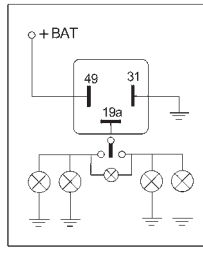

Voltage: 12
Watt: 3/92

Plug type: Flat
Terminals: 3
Bracket: w/

160341 Flasher Unit

Servicing: Alfa Romeo, Audi, Austin, BMW, Citroen, Fiat, Ford, Honda, Lada, Mercedes-Benz, Opel, Peugeot, Porsche - Visit www.hc-cargo.com for further information

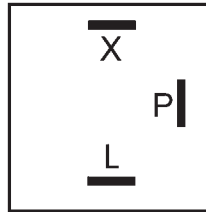

Voltage: 12
Amp: 16
Watt: 180

Terminals: 3
Bracket: w/

160402 Flasher Unit

For vehicles w/ towbars.

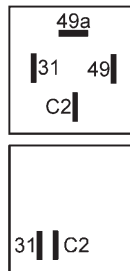

Voltage: 12
Watt: 2+1/6x21

Terminals: 4+2/top
Bracket: w/o

160474 Flasher Unit

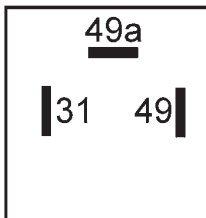

Voltage: 12
Watt: 2/4x21

Terminals: 3
Bracket: w/o

160475 Flasher Unit

For vehicles w/ towbars.

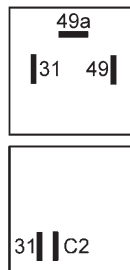

Voltage: 12
Watt: 2+1/6x21

Terminals: 3+2/top
Bracket: w/o

160791 Flasher Unit

Servicing: BMW, Saab - Visit www.hc-cargo.com for further information

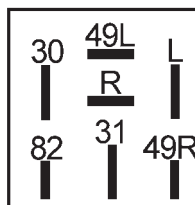

Voltage: 12

Terminals: 7
Bracket: w/o

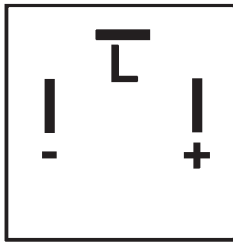
W/ LED
160948 Flasher Unit

 Voltage: 12
Watt: 0.1-150

Height: 30 mm

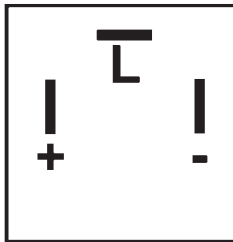
 Plug type: Flat
Terminals: 3
Bracket: w/o

160949 Flasher Unit

 Voltage: 12
Watt: 0.1-150

Height: 30 mm

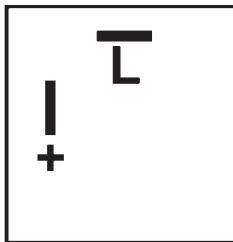
 Plug type: Flat
Terminals: 3
Bracket: w/o

160950 Flasher Unit

 Voltage: 12
Watt: 0.1-150

Height: 30 mm

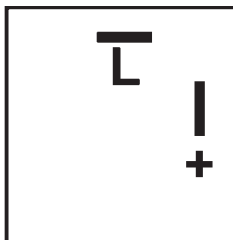
 Plug type: Flat
Terminals: 2
Bracket: w/o

160951 Flasher Unit

 Voltage: 12
Watt: 0.1-150

Height: 30 mm

 Plug type: Flat
Terminals: 2
Bracket: w/o

160954 i-LS sensor
In combination w/ an I-LS flasher unit, the I-LS sensor secures the legal requirements of "lamp failure warning".



Voltage: 12

Height: 26 mm

 Terminals: 3
Bracket: w/o

160956 Flasher Unit i-LS

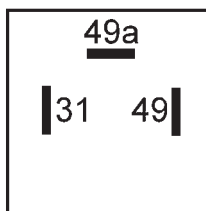
 Servicing: Vehicles w/ 2 LED lamps on front or rear - Visit www.hc-cargo.com for further information

In combination w/ an I-LS sensor, the I-LS flasher relay secures the legal requirements of "lamp failure warning" by installed LED lamps.

 Voltage: 12
Watt: 90

 Terminals: 3
Bracket: w/

160957 Flasher Unit I-LS

Servicing: Vehicles w/ trailer, w/ 2 LED lamps - Visit www.hc-cargo.com for further information

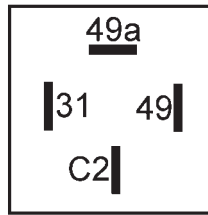
In combination w/ an I-LS sensor, the I-LS flasher relay secures the legal requirements of "lamp failure warning" by installed LED lamps.



Voltage: 12
Watt: 170

Terminals: 4
Bracket: w/

FLASHER UNITS - 24 V

160199 Flasher Unit

Servicing: Mazda, Volvo - Visit www.hc-cargo.com for further information

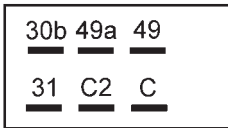

Voltage: 24
Watt: 3+1/8x21

Terminals: 6
Bracket: w/

160261 Flasher Unit

Servicing: Mercedes-Benz - Visit www.hc-cargo.com for further information

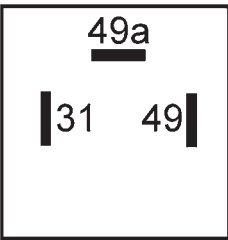

Voltage: 24
Watt: 2/4x21

Terminals: 3
Bracket: w/

160262 Flasher Unit

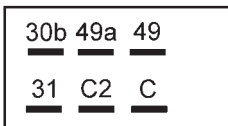

Voltage: 24
Watt: 2+1/6x21

Terminals: 6
Bracket: w/

160296 Flasher Unit

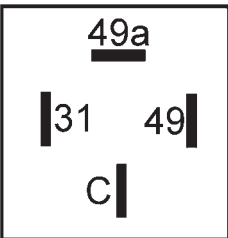

Voltage: 24
Watt: 2/4x21

Terminals: 4
Bracket: w/

160313 Flasher Unit

Interchangeable w/ all 4 terminal device (+, -, C, R). for SAE standard vehicles (France, Italy, USA, Spain).

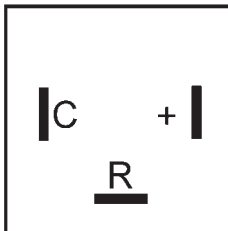

Voltage: 24
Watt: 2/4x21

Terminals: 3
Bracket: w/

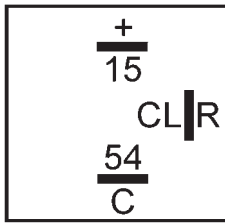
160716 Flasher Unit

 Voltage: 24
Watt: 500

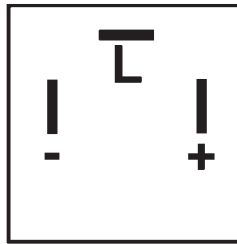
 Plug type: Flat
Terminals: 3
Bracket: w/

W/ LED
160952 Flasher Unit

 Voltage: 24
Watt: 0.1-150

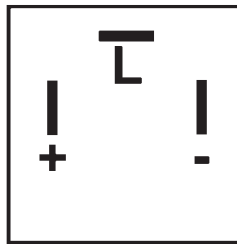
Height: 30 mm

 Plug type: Flat
Terminals: 3
Bracket: w/o

160953 Flasher Unit

 Voltage: 24
Watt: 0.1-150

Height: 30 mm

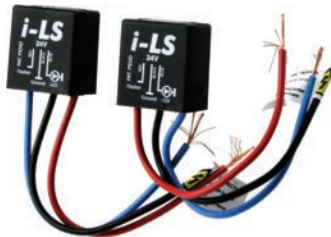
 Plug type: Flat
Terminals: 3
Bracket: w/o

160955 i-LS Sensor
In combination w/ an I-LS flasher unit, the I-LS sensor secures the legal requirements of "lamp failure warning".

Voltage: 24

 Terminals: 3
Bracket: w/o

160958 Flasher Unit i-LS

 Servicing: Vehicles w/ 2 LED lamps on front or rear - Visit www.hc-cargo.com for further information

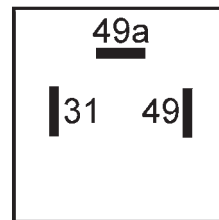
In combination w/ an I-LS sensor, the I-LS flasher relay secures the legal requirements of "lamp failure warning" by installed LED lamps.

 Voltage: 24
Watt: 90

 Terminals: 3
Bracket: w/

160959 Flasher Unit i-LS

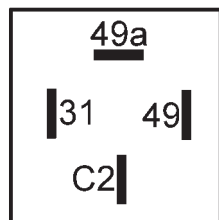
 Servicing: Vehicles w/ trailer, w/ 2 LED lamps - Visit www.hc-cargo.com for further information

In combination w/ an I-LS sensor, the I-LS flasher relay secures the legal requirements of "lamp failure warning" by installed LED lamps.

 Voltage: 24
Watt: 170

 Terminals: 4
Bracket: w/

CHARGE RELAYS

160407 Charge Relay

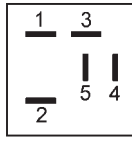
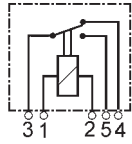
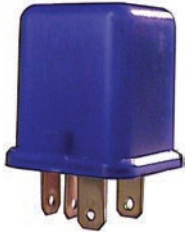
5 terminals.



Amp: 20

Bracket: w/o

POWR-BLOKS

191717 Powr-Blok

Servicing: HC-CARGO 191733, 191734

The POWR-BLOKSTM system gives you unlimited flexibility to design electrical distribution systems that range from simple to complex. Choose from a variety of POWR-BLOKSTM modules that accommodate everything you need in power distribution or circuit protection blocks, including fuses, circuit breakers, relays, flashers and specialty devices. It is the totally modular way to build your own junction block. Typical Applications: Buses, Conversion Vans, Off Road and Recreational Vehicles, Construction Equipment, Emergency Vehicles, Farm Equipment, Heavy Duty Trucks, Industrial Vehicles, Marine, High Performance and Racing Vehicles. Terminals: HC-CARGO 191733, 191734.



Height: 30.48 mm
Module: Fuse holder

Type/fuse: ATO
Outlets: 2 way

191718 Powr-Blok

The POWR-BLOKSTM system gives you unlimited flexibility to design electrical distribution systems that range from simple to complex. Choose from a variety of POWR-BLOKSTM modules that accommodate everything you need in power distribution or circuit protection blocks, including fuses, circuit breakers, relays, flashers and specialty devices. It is the totally modular way to build your own junction block. Typical Applications: Buses, Conversion Vans, Off Road and Recreational Vehicles, Construction Equipment, Emergency Vehicles, Farm Equipment, Heavy Duty Trucks, Industrial Vehicles, Marine, High Performance and Racing Vehicles. Terminals: HC-CARGO 191733, 191734.

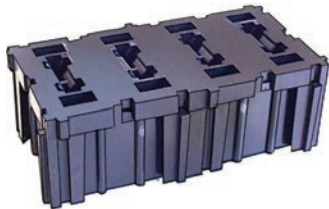

Height: 30.48 mm
Module: Fuse holder

Type/fuse: ATO
Outlets: 4 way

191719 Powr-Blok

The POWR-BLOKSTM system gives you unlimited flexibility to design electrical distribution systems that range from simple to complex. Choose from a variety of POWR-BLOKSTM modules that accommodate everything you need in power distribution or circuit protection blocks, including fuses, circuit breakers, relays, flashers and specialty devices. It is the totally modular way to build your own junction block. Typical Applications: Buses, Conversion Vans, Off Road and Recreational Vehicles, Construction Equipment, Emergency Vehicles, Farm Equipment, Heavy Duty Trucks, Industrial Vehicles, Marine, High Performance and Racing Vehicles. Terminals: HC-CARGO 191733, 191734.

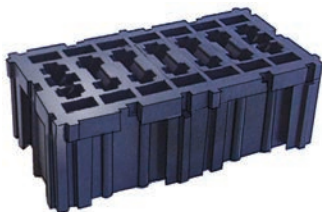

Height: 30.48 mm
Module: Fuse holder

Type/fuse: ATO
Outlets: 7 way

191721 Powr-Blok

The POWR-BLOKSTM system gives you unlimited flexibility to design electrical distribution systems that range from simple to complex. Choose from a variety of POWR-BLOKSTM modules that accommodate everything you need in power distribution or circuit protection blocks, including fuses, circuit breakers, relays, flashers and specialty devices. It is the totally modular way to build your own junction block. Typical Applications: Buses, Conversion Vans, Off Road and Recreational Vehicles, Construction Equipment, Emergency Vehicles, Farm Equipment, Heavy Duty Trucks, Industrial Vehicles, Marine, High Performance and Racing Vehicles. Terminals: HC-CARGO 191735, 191736.

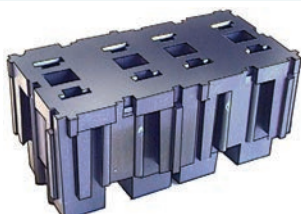

Height: 33.02 mm
Module: Fuse holder

Type/fuse: Maxi
Outlets: 4 way
No./relays: 1

191722 Powr-Blok Relay Multi Plug

The POWR-BLOKSTM system gives you unlimited flexibility to design electrical distribution systems that range from simple to complex. Choose from a variety of POWR-BLOKSTM modules that accommodate everything you need in power distribution or circuit protection blocks, including fuses, circuit breakers, relays, flashers and specialty devices. It is the totally modular way to build your own junction block. Typical Applications: Buses, Conversion Vans, Off Road and Recreational Vehicles, Construction Equipment, Emergency Vehicles, Farm Equipment, Heavy Duty Trucks, Industrial Vehicles, Marine, High Performance and Racing Vehicles. Terminals: HC-CARGO 191764, 191765, 191766.

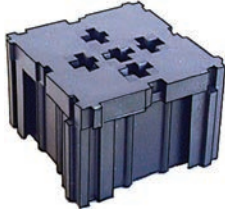

Height: 25.4 mm
Module: Relay holder

Type/fuse: ISO

191723 Powr-Blok Relay Multi Plug

The POWR-BLOKSTM system gives you unlimited flexibility to design electrical distribution systems that range from simple to complex. Choose from a variety of POWR-BLOKSTM modules that accommodate everything you need in power distribution or circuit protection blocks, including fuses, circuit breakers, relays, flashers and specialty devices. It is the totally modular way to build your own junction block. Typical Applications: Buses, Conversion Vans, Off Road and Recreational Vehicles, Construction Equipment, Emergency Vehicles, Farm Equipment, Heavy Duty Trucks, Industrial Vehicles, Marine, High Performance and Racing Vehicles. Terminals: HC-CARGO 191764, 191765, 191766.



Height: 25.4 mm
Module: Relay holder

Type/fuse: ISO
No./relays: 2

191724 Powr-Blok

The POWR-BLOKSTM system gives you unlimited flexibility to design electrical distribution systems that range from simple to complex. Choose from a variety of POWR-BLOKSTM modules that accommodate everything you need in power distribution or circuit protection blocks, including fuses, circuit breakers, relays, flashers and specialty devices. It is the totally modular way to build your own junction block. Typical Applications: Buses, Conversion Vans, Off Road and Recreational Vehicles, Construction Equipment, Emergency Vehicles, Farm Equipment, Heavy Duty Trucks, Industrial Vehicles, Marine, High Performance and Racing Vehicles. Terminals 4.7 mm: HC-CARGO 191737, 191738. Terminals 6.3 mm: HC-CARGO 191764, 191765, 191766.

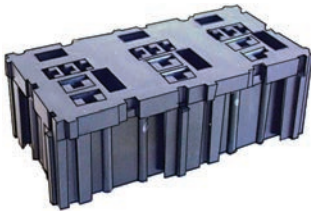

Height: 30.48 mm
Module: Relay holder

Type/fuse: Micro
No./relays: 3

191725 Powr-Blok Stud Module

The POWR-BLOKSTM system gives you unlimited flexibility to design electrical distribution systems that range from simple to complex. Choose from a variety of POWR-BLOKSTM modules that accommodate everything you need in power distribution or circuit protection blocks, including fuses, circuit breakers, relays, flashers and specialty devices. It is the totally modular way to build your own junction block. Typical Applications: Buses, Conversion Vans, Off Road and Recreational Vehicles, Construction Equipment, Emergency Vehicles, Farm Equipment, Heavy Duty Trucks, Industrial Vehicles, Marine, High Performance and Racing Vehicles.

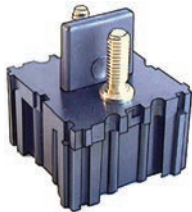

Height: 44.45 mm

Type/fuse: Assemble

191726 Powr-Blok Relay Socket

The POWR-BLOKSTM system gives you unlimited flexibility to design electrical distribution systems that range from simple to complex. Choose from a variety of POWR-BLOKSTM modules that accommodate everything you need in power distribution or circuit protection blocks, including fuses, circuit breakers, relays, flashers and specialty devices. It is the totally modular way to build your own junction block. Typical Applications: Buses, Conversion Vans, Off Road and Recreational Vehicles, Construction Equipment, Emergency Vehicles, Farm Equipment, Heavy Duty Trucks, Industrial Vehicles, Marine, High Performance and Racing Vehicles. Terminals 6.3 mm: HC-CARGO 191764, 191765, 191766. Terminals 9.5 mm: HC-CARGO 191025.

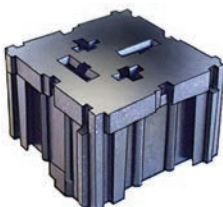

Height: 25.4 mm
Module: Relay holder

Type/fuse: Power
No./relays: 1

191744 Powr-Blok

The POWR-BLOKSTM system gives you unlimited flexibility to design electrical distribution systems that range from simple to complex. Choose from a variety of POWR-BLOKSTM modules that accommodate everything you need in power distribution or circuit protection blocks, including fuses, circuit breakers, relays, flashers and specialty devices. It is the totally modular way to build your own junction block. Typical Applications: Buses, Conversion Vans, Off Road and Recreational Vehicles, Construction Equipment, Emergency Vehicles, Farm Equipment, Heavy Duty Trucks, Industrial Vehicles, Marine, High Performance and Racing Vehicles. Terminals: HC-CARGO 191739, 191740.



Height: 34.29 mm
Module: Fuse holder

Type/fuse: Mini

191767 Powr-Blok Mounting

The POWR-BLOKSTM system gives you unlimited flexibility to design electrical distribution systems that range from simple to complex. Choose from a variety of POWR-BLOKSTM modules that accommodate everything you need in power distribution or circuit protection blocks, including fuses, circuit breakers, relays, flashers and specialty devices. It is the totally modular way to build your own junction block. Typical Applications: Buses, Conversion Vans, Off Road and Recreational Vehicles, Construction Equipment, Emergency Vehicles, Farm Equipment, Heavy Duty Trucks, Industrial Vehicles, Marine, High Performance and Racing Vehicles. Mounting accessory modules designed for mounting fuse block to be used w/ mounting stand -off.



Height: 76.2 mm

BRIDGE

191741 Powr-Blok

Powr-blok: HC-CARGO 191717.



Outlets: 2 way

191742 Powr-Blok

Powr-blok: HC-CARGO 191718.



Outlets: 4 way

191743 Powr-Blok

Powr-blok: HC-CARGO 191719.



Outlets: 7 way

ACCESSORIES

191727 Powr-Blok Connecting Locks

Insertable/removable locks designed to connect Powr-blok modules.

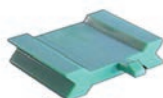

Height: 20.32 mm

191728 Powr-Blok
I.D. 8 mm. O.D. 25 mm. Rigid plastic.

Height: 19 mm

191729 Powr-Blok

Height: 25.4 mm

191730 Powr-Blok

Height: 31.7 mm

191731 Powr-Blok Mounting Leg

Height: 25 mm

191732 Powr-Blok Mounting Leg

Height: 76.2 mm

191745 Powr-Blok Seal

Servicing: HC-CARGO 191744



Height: 36.07 mm

Type/fuse: Mini

191746 Powr-Blok Plastic Cover

Servicing: HC-CARGO 191744



Height: 36.07 mm

Type/fuse: Mini

SWITCHES

ROTATING

180007 3-Way Switch

 Voltage: 12/24
Watt: 3

Mount. hole size: 26 mm

 Socket type: BA7s
Button colour: Black
Switch: On/Off/On
Terminals: 7
Illuminated: Yes
Bulb incl.: No

	EL. SPECIFICATIONS	DIMENSIONS	ADDITIONAL SPECIFICATIONS
180599 Mini Rocker Switch 	Servicing: Citroen, Fiat - Visit www.hc-cargo.com for further information Voltage: 12 Amp: 20	Mount. hole size: 21 mm	Type/terminal: Flat Button colour: Red Switch: On/Off Terminals: 3 Illuminated: Yes
180600 Mini Rocker Switch 	Voltage: 12 Amp: 10	Mount. hole size: 21 mm	Button colour: Black Switch: On/On Terminals: 3
180601 Mini Rocker Switch 	Voltage: 12 Amp: 20	Mount. hole size: 20 mm	Type/terminal: Flat Button colour: Red Switch: On/Off Terminals: 3 Bulb: LED Illuminated: Yes
180627 Mini Rocker Switch 	Voltage: 12 Amp: 20	Mount. hole size: 21 mm	Type/terminal: Flat Button colour: Blue Switch: On/Off Terminals: 3 Illuminated: Yes
180628 Mini Rocker Switch 	Voltage: 12 Amp: 20	Mount. hole size: 21 mm	Type/terminal: Flat Button colour: Green Switch: On/Off Terminals: 3 Illuminated: Yes
181557 Mini Rocker Switch 	Voltage: 12 Amp: 20	Mount. hole size: 20 mm	Button colour: Orange Switch: On/Off Material: Plastic Bulb: LED Automatic return: No
181558 Mini Rocker Switch 	Voltage: 12 Amp: 20	Mount. hole size: 20 mm	Type/terminal: Flat Button colour: Blue Switch: On/Off Material: Plastic Terminals: 3 Bulb: LED Illuminated: Yes Automatic return: No

	EL. SPECIFICATIONS	DIMENSIONS	ADDITIONAL SPECIFICATIONS
181559 Mini Rocker Switch		Voltage: 12 Amp: 20	Mount. hole size: 20 mm Type/terminal: Flat Button colour: Green Switch: On/Off Material: Plastic Terminals: 3 Bulb: LED Illuminated: Yes Automatic return: No
181607 Mini Rocker Switch		Voltage: 24 Amp: 10	Mount. hole size: 21 mm Type/terminal: Flat Button colour: Red Switch: On/Off Terminals: 3 Bulb: LED Illuminated: Yes
181608 Mini Rocker Switch		Voltage: 24 Amp: 10	Mount. hole size: 20 mm Type/terminal: Flat Button colour: Orange Switch: On/Off Terminals: 3 Bulb: LED Illuminated: Yes
181609 Mini Rocker Switch		Voltage: 24 Amp: 10	Mount. hole size: 20 mm Type/terminal: Flat Button colour: Blue Switch: On/Off Terminals: 3 Bulb: LED Illuminated: Yes
181610 Mini Rocker Switch		Voltage: 24 Amp: 10	Mount. hole size: 20 mm Type/terminal: Flat Button colour: Green Switch: On/Off Terminals: 3 Bulb: LED Illuminated: Yes
ROCKER			
180090 Rocker Switch		Voltage: 12 Amp: 16 Voltage 2: 24 Amp 2: 8	Mount. hole size: 28.5x11.5 mm Switch: On/Off No./terminals w/screw: 2
180099 Rocker Switch	<i>Supplied w/ 12 V bulb.</i> 	Voltage: 12 Amp: 16	Mount. hole size: 28.5x11.5 mm Button colour: Blue Switch: On/Off No./terminals w/screw: 3 Illuminated: Yes

180100 Rocker Switch

Supplied w/ 12 V bulb.

 Voltage: 12
Amp: 16

 Mount. hole size:
28.5x11.5 mm

 Button colour: Green
Switch: On/Off
No./terminals w/screw: 3
Illuminated: Yes

180101 Rocker Switch

Supplied w/ 12 V bulb.

 Voltage: 12
Amp: 16

 Mount. hole size:
28.5x11.5 mm

 Button colour: Red
Switch: On/Off
No./terminals w/screw: 3
Illuminated: Yes

180176 Rocker Switch

 Voltage: 12
Amp: 10
Voltage 2: 24
Amp 2: 5

Mount. hole size: 12.5 mm

 Switch: On/Off
Terminals: 2

180177 Rocker Switch

Supplied w/ 12 V bulb.

 Voltage: 12
Amp: 10

Mount. hole size: 12.5 mm

 Button colour: Blue
Switch: On/Off
No./terminals w/screw: 3
Illuminated: Yes

180178 Rocker Switch

Supplied w/ 12 V bulb.

 Voltage: 12
Amp: 10

Mount. hole size: 12.5 mm

 Button colour: Green
Switch: On/Off
No./terminals w/screw: 3
Illuminated: Yes

180179 Rocker Switch

Supplied w/ 12 V bulb.

 Voltage: 12
Amp: 10

Mount. hole size: 12.5 mm

 Button colour: Red
Switch: On/Off
No./terminals w/screw: 3
Illuminated: Yes

180180 Rocker Switch

Supplied w/ 12 V bulb.

 Voltage: 12
Amp: 10

Mount. hole size: 12.5 mm

 Button colour: Orange
Switch: On/Off
No./terminals w/screw: 3
Illuminated: Yes

	EL. SPECIFICATIONS	DIMENSIONS	ADDITIONAL SPECIFICATIONS
180206 Rocker Switch			
Servicing: HC-CARGO 180208 <i>w/o symbol plate. Illuminated w/ location and function light. Bulb: HC-CARGO 181615, 181667 (LED).</i>			
	Voltage: 12 Amp: 16 Watt: 1.2	Mount. hole size: 22.1x44.1 mm	Socket type: T5 Switch: On/Off No./terminals w/screw: 4 Bulb: HC-CARGO 170758 Illuminated: Yes Bulb incl.: Yes
180207 Rocker Switch			
Servicing: HC-CARGO 180208 <i>w/o symbol plate. Illuminated w/ location and function light. Bulb: HC-CARGO 181632, 181668 (LED).</i>			
	Voltage: 24 Amp: 8 Watt: 1.2	Mount. hole size: 22.1x44.1 mm	Socket type: T5 Switch: On/Off No./terminals w/screw: 4 Illuminated: Yes Bulb incl.: Yes
181546 Rocker Switch			
Servicing: HC-CARGO 180208 <i>w/o symbol plate. Illuminated w/ location and function light. Bulb: HC-CARGO 181615, 181667 (LED), 181632, 181668 (LED).</i>			
	Voltage: 12/24	Mount. hole size: 22.1x44.1 mm	Type/terminal: Flat Switch: (On)/Off/(On) Terminals: 6 Bulb incl.: No Automatic return: Yes
181554 Rocker Switch			
	Voltage: 12 Amp: 16	Mount. hole size: 12.5 mm	Button colour: Orange Switch: On/Off Material: Plastic Terminals: 2 Bulb: LED Automatic return: No
181555 Rocker Switch			
	Voltage: 12 Amp: 16	Mount. hole size: 12.5 mm	Button colour: Green Switch: On/Off Material: Plastic Terminals: 2 Bulb: LED Automatic return: No
181556 Rocker Switch			
	Voltage: 12 Amp: 16	Mount. hole size: 12.5 mm	Button colour: Red Switch: On/Off Material: Plastic Terminals: 2 Bulb: LED Automatic return: No

181638 Rocker Switch

w/o symbol plate. Illuminated w/ location and function light. Bulb: HC-CARGO 181615, 181667 (LED).

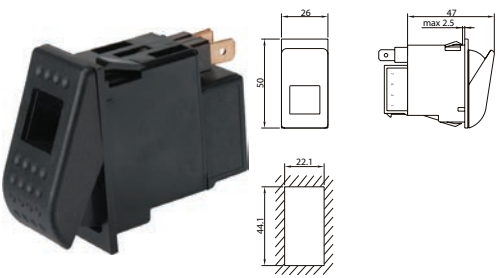

Voltage: 12
Amp: 16
Watt: 1.2

Mount. hole size:
22.1x44.1 mm

Socket type: T5
Switch: On/Off
No./terminals w/screw: 4
Bulb incl.: Yes
Automatic return: Yes

181639 Rocker Switch

w/o symbol plate. Illuminated w/ location and function light. Bulb: HC-CARGO 181632, 181668 (LED).

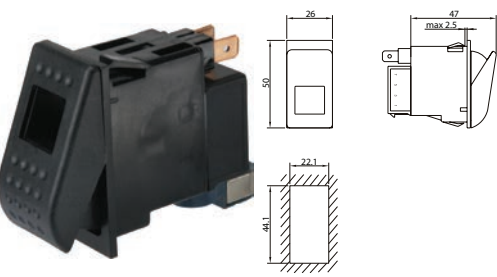

Voltage: 24
Amp: 8
Watt: 1.2

Mount. hole size:
22.1x44.1 mm

Socket type: T5
Switch: On/Off
No./terminals w/screw: 4
Bulb incl.: Yes
Automatic return: Yes

181640 Rocker Switch

w/o symbol plate. Illuminated w/ location and function light. Bulb: HC-CARGO 181615, 181667 (LED), 181632, 181668 (LED).



Voltage: 12/24

Mount. hole size:
22.1x44.1 mm

Type/terminal: Flat
Switch: (On)/Off/(On)
Terminals: 6
Bulb incl.: No
Automatic return: Yes

211123 Rocker Switch

Servicing: HC-CARGO 211083, 211097



Voltage: 12/24

Type/terminal: Flat
Terminals: 3

ACCESSORIES

180208 Multi Plug

Servicing: HC-CARGO 180206, 180207, 181546, 181638, 181639, 181640

For SWF-type switches. Terminal: HC-CARGO 19025, 190868, 192377, 192376, 191029.



Type/terminal: Flat
No./poles: 8
Plug: Female

181561 Plastic Module Panel









Servicing: HC-CARGO 180090, 180099, 180100, 180101









1 hole.









Mount. hole size:
28.5x11.5 mm

EL. SPECIFICATIONS	DIMENSIONS	ADDITIONAL SPECIFICATIONS
181615 Bulb Holder 12 V Servicing: HC-CARGO 180206, 181546, 181638, 181640		
	Voltage: 12	
181632 Bulb Holder 24 V Servicing: HC-CARGO 180207, 181546, 181639, 181640		
	Voltage: 24	
181667 Bulb Holder 12 V LED Servicing: HC-CARGO 180206, 181546, 181667, 181640		
	Voltage: 12	
181668 Bulb Holder 24 V LED Servicing: HC-CARGO 180207, 181546, 181639, 181640		
	Voltage: 24	
180209 Symbol Plate Servicing: HC-CARGO 180206, 180207, 181546, 181638, 181639, 181640		
		Colour: Yellow Symbol: Rotating beacon
180210 Symbol Plate Servicing: HC-CARGO 180206, 180207, 181546, 181638, 181639, 181640		
		Colour: Green Symbol: Work Light, front
181462 Symbol Plate Servicing: HC-CARGO 180206, 180207, 181546, 181638, 181639, 181640		
		Colour: Green

	EL. SPECIFICATIONS	DIMENSIONS	ADDITIONAL SPECIFICATIONS
181463 Symbol Plate	Servicing: HC-CARGO 180206, 180207, 181546, 181638, 181639, 181640		Colour: Red
			
181641 Symbol Plate	Servicing: HC-CARGO 180206, 180207, 181546, 181638, 181639, 181640		Colour: Green Symbol: High Beam
			
181642 Symbol Plate	Servicing: HC-CARGO 180206, 180207, 181546, 181638, 181639, 181640		Colour: Green Symbol: Fog Light
			
181643 Symbol Plate	Servicing: HC-CARGO 180206, 180207, 181546, 181638, 181639, 181640		Colour: Black Symbol: Parking light
			
181644 Symbol Plate	Servicing: HC-CARGO 180206, 180207, 181546, 181638, 181639, 181640		Colour: Red Symbol: Hazard Warning Lamp
			
181645 Symbol Plate	Servicing: HC-CARGO 180206, 180207, 181546, 181638, 181639, 181640		Colour: Black Symbol: Interior Lighting
			
181646 Symbol Plate	Servicing: HC-CARGO 180206, 180207, 181546, 181638, 181639, 181640		Colour: Green Symbol: Work Light
			
181647 Symbol Plate	Servicing: HC-CARGO 180206, 180207, 181546, 181638, 181639, 181640		Colour: Green Symbol: Work Light
			

	EL. SPECIFICATIONS	DIMENSIONS	ADDITIONAL SPECIFICATIONS
181648 Symbol Plate	Servicing: HC-CARGO 180206, 180207, 181546, 181638, 181639, 181640		Colour: Black Symbol: Loading Floor Lamp
			
181649 Symbol Plate	Servicing: HC-CARGO 180206, 180207, 181546, 181638, 181639, 181640		Colour: Green Symbol: Rotating beacon
			
181650 Symbol Plate	Servicing: HC-CARGO 180206, 180207, 181546, 181638, 181639, 181640		Colour: Green Symbol: Wiper & Washer
			
181651 Symbol Plate	Servicing: HC-CARGO 180206, 180207, 181546, 181638, 181639, 181640		Colour: Green Symbol: Horn
			
181652 Symbol Plate	Servicing: HC-CARGO 180206, 180207, 181546, 181638, 181639, 181640		Colour: Green Symbol: Blower
			
181653 Symbol Plate	Servicing: HC-CARGO 180206, 180207, 181546, 181638, 181639, 181640		Colour: Green Symbol: Washer
			
181654 Symbol Plate	Servicing: HC-CARGO 180206, 180207, 181546, 181638, 181639, 181640		Colour: Green Symbol: Windscreen Wiper
			
181655 Symbol Plate	Servicing: HC-CARGO 180206, 180207, 181546, 181638, 181639, 181640		Colour: Green Symbol: Seat Heating
			

	EL. SPECIFICATIONS	DIMENSIONS	ADDITIONAL SPECIFICATIONS
181656 Symbol Plate	Servicing: HC-CARGO 180206, 180207, 181546, 181638, 181639, 181640		Colour: Green Symbol: Parking Brake
			
181657 Symbol Plate	Servicing: HC-CARGO 180206, 180207, 181546, 181638, 181639, 181640		Colour: Green Symbol: Indicator
			
181658 Symbol Plate	Servicing: HC-CARGO 180206, 180207, 181546, 181638, 181639, 181640		Colour: Green Symbol: Rear Window Wiper
			
181659 Symbol Plate	Servicing: HC-CARGO 180206, 180207, 181546, 181638, 181639, 181640		Colour: Green Symbol: Rear Windscreen Wash
			
181660 Symbol Plate	Servicing: HC-CARGO 180206, 180207, 181546, 181638, 181639, 181640		Colour: White Symbol: Heating & Ventilation
			
181661 Blind cover	Servicing: HC-CARGO 180206, 180207, 181546, 181638, 181639, 181640		
			
181662 Plastic Module Panel	Servicing: HC-CARGO 180206, 180207, 181546, 181638, 181639, 181640		
			
181663 Plastic Module Panel	Servicing: HC-CARGO 180206, 180207, 181546, 181638, 181639, 181640		
<i>Can be assembled in rows.</i>			
			

181664 Plastic Module Panel

Servicing: HC-CARGO 180206, 180207, 181546, 181638, 181639, 181640

Can be assembled in rows (end piece.)



181665 Plastic Module Panel

Servicing: HC-CARGO 180206, 180207, 181546, 181638, 181639, 181640

3 holes.



181666 Plastic Module Panel

Servicing: HC-CARGO 180206, 180207, 181546, 181638, 181639, 181640

6 holes.



TOGGLE

METAL ARM

180039 3-Way Switch

For steering column of 35-40 mm.



Voltage: 12
Amp: 16
Voltage 2: 24
Amp 2: 8
Watt: 1.5

Socket type: T-1 1/2
Button colour: Green
Bulb: T 1 1/2 Midget
Illuminated: Yes
Bulb incl.: Yes

180048 3-Way Switch

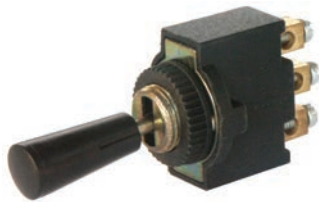

Voltage: 12
Amp: 20

Mount. hole size: 12.5 mm

Button colour: Black
Switch: On/Off/On
Terminals: 3

180584 Toggle Switch



Voltage: 12
Amp: 16
Voltage 2: 24
Amp 2: 8

Mount. hole size: 12 mm

Switch: On/Off
Material: Metal
Terminals: 2
Arm: Short







180585 Toggle Switch







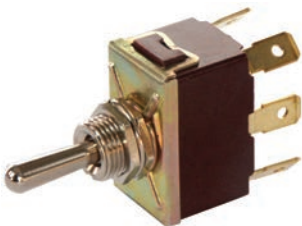

Voltage: 12
Amp: 16
Voltage 2: 24
Amp 2: 8

Mount. hole size: 12 mm

Switch: On/(On)
Material: Metal
Terminals: 3
Arm: Short

	EL. SPECIFICATIONS	DIMENSIONS	ADDITIONAL SPECIFICATIONS
180586 Toggle Switch 	Voltage: 12 Amp: 16 Voltage 2: 24 Amp 2: 8	Mount. hole size: 12 mm	Switch: On/On Material: Metal Terminals: 3 Arm: Short
180587 Toggle Switch 	Voltage: 12 Amp: 16 Voltage 2: 24 Amp 2: 8	Mount. hole size: 12 mm	Switch: (On)/Off/(On) Material: Metal Terminals: 3 Arm: Short
180588 Toggle Switch 	Voltage: 12 Amp: 16 Voltage 2: 24 Amp 2: 8	Mount. hole size: 12 mm	Servicing: Ford - Visit www.hc-cargo.com for further information Switch: On/Off/(On) Material: Metal Terminals: 3 Arm: Short
180589 Toggle Switch 	Voltage: 12 Amp: 16 Voltage 2: 24 Amp 2: 8	Mount. hole size: 12 mm	Switch: On/Off/On Material: Metal Terminals: 3 Arm: Short
180590 Toggle Switch 	Voltage: 12 Amp: 16 Voltage 2: 24 Amp 2: 8	Mount. hole size: 12 mm	Switch: On/Off Material: Metal Terminals: 4 Arm: Short 2 poles: w/
180591 Toggle Switch 	Voltage: 12 Amp: 16 Voltage 2: 24 Amp 2: 8	Mount. hole size: 12 mm	Switch: On/On Material: Metal Terminals: 6 Arm: Short 2 poles: w/
180592 Toggle Switch 	Voltage: 12 Amp: 16 Voltage 2: 24 Amp 2: 8	Mount. hole size: 12 mm	Switch: (On)/Off/(On) Material: Metal Terminals: 6 Arm: Short 2 poles: w/

	EL. SPECIFICATIONS	DIMENSIONS	ADDITIONAL SPECIFICATIONS
180593 Toggle Switch		Voltage: 12 Amp: 16 Voltage 2: 24 Amp 2: 8	Mount. hole size: 12 mm Switch: On/Off/(On) Material: Metal Terminals: 6 Arm: Short 2 poles: w/
180594 Toggle Switch		Voltage: 12 Amp: 16 Voltage 2: 24 Amp 2: 8	Mount. hole size: 12 mm Switch: On/Off/On Material: Metal Terminals: 6 Arm: Short 2 poles: w/
180618 Toggle Switch		Voltage: 12 Amp: 6 Voltage 2: 24 Amp 2: 3	Mount. hole size: 12 mm Switch: (On)/Off/(On) Material: Metal Terminals: 3 Arm: Long
181276 Mini Toggle Switch	<i>Mini.</i>		
	Voltage: 12 Amp: 6 Voltage 2: 24 Amp 2: 3	Mount. hole size: 6 mm	Switch: On/Off Material: Metal Terminals: 2 Arm: Short
181277 Mini Toggle Switch	<i>Mini.</i>		
	Voltage: 12 Amp: 6 Voltage 2: 24 Amp 2: 3	Mount. hole size: 6 mm	Switch: On/On Material: Metal Terminals: 3 Arm: Short
181278 Mini Toggle Switch		Voltage: 12 Amp: 6 Voltage 2: 24 Amp 2: 3	Mount. hole size: 6 mm Switch: On/Off/On Material: Metal Terminals: 3 Arm: Short
PLAST ARM			
180018 Toggle Switch		Voltage: 12 Amp: 10 Voltage 2: 24 Amp 2: 5	Mount. hole size: 12.5 mm Colour: Black Switch: On/Off Terminals: 2 Arm: Long

	EL. SPECIFICATIONS	DIMENSIONS	ADDITIONAL SPECIFICATIONS
180036 3-Way Switch 	Voltage: 12 Amp: 16 Voltage 2: 24 Amp 2: 8	Mount. hole size: 12.5 mm	Button colour: Black Switch: On/Off/On Terminals: 3
180088 Toggle Switch 	Voltage: 12 Amp: 16 Voltage 2: 24 Amp 2: 8	Mount. hole size: 12.5 mm	Colour: Black Switch: Off/(On) Terminals: 2 Arm: Short
180091 Toggle Switch 	Voltage: 12 Amp: 10	Mount. hole size: 12.5 mm	Colour: Blue Switch: On/Off Terminals: 3 Arm: Short Illuminated: Yes Bulb incl.: Yes
180092 Toggle Switch 	Voltage: 12 Amp: 10	Mount. hole size: 12.5 mm	Colour: Green Switch: On/Off Terminals: 3 Arm: Short Illuminated: Yes Bulb incl.: Yes
180094 Toggle Switch 	Voltage: 12 Amp: 10	Mount. hole size: 12.5 mm	Colour: Red Switch: On/Off Terminals: 3 Arm: Short Illuminated: Yes Bulb incl.: Yes
180140 Toggle Switch 	Voltage: 12 Amp: 10 Voltage 2: 24 Amp 2: 5	Mount. hole size: 12.5 mm	Colour: Black Switch: On/Off Terminals: 2 Arm: Short
180141 Toggle Switch 	Voltage: 12 Amp: 5 Voltage 2: 24 Amp 2: 2.5	Mount. hole size: 12.5 mm	Colour: Black Switch: On/On Terminals: 3 Arm: Short 2 poles: w/

ACCESSORIES			
180595 Rubber Boot		Servicing: HC-CARGO 180584-594	
			Material: Rubber
181551 Cover For Toggle Switch		Servicing: HC-CARGO 180584, 180594	
			Colour: Red Automatic return: Yes
181552 Cover For Toggle Switch		Servicing: HC-CAROG 180584, 180594	
			Colour: Yellow Automatic return: Yes
181553 Plastic Module Panel			
<i>1 hole.</i>			
		Mount. hole size: 12 mm	
PUSH-PULL			
180010 Push/Pull Switch			
<i>For lights ect.</i>			
	Voltage: 12	Mount. hole size: 10 mm	Button colour: Black Switch: On/Off/On
180021 Push/Pull Switch			
<i>Max. 3 W BA 7 bulb.</i>			
	Voltage: 12 Amp: 6 Voltage 2: 24 Amp 2: 3	Mount. hole size: 12.5 mm	Type/terminal: Flat Button colour: Orange Switch: On/Off Terminals: 2 Illuminated: Yes Bulb incl.: No
180022 Push/Pull Switch			
<i>Max. 3 W BA 7 bulb.</i>			
	Voltage: 12 Amp: 6 Voltage 2: 24 Amp 2: 3	Mount. hole size: 12.5 mm	Type/terminal: Terminal Button colour: Green Switch: On/Off Terminals: 2 Illuminated: Yes Bulb incl.: No

180023 Push/Pull Switch
Max. 3 W BA 7 bulb.

 Voltage: 12
 Amp: 6
 Voltage 2: 24
 Amp 2: 3

Mount. hole size: 12.5 mm

 Type/terminal: Terminal
 Button colour: Red
 Switch: On/Off
 Terminals: 2
 Illuminated: Yes
 Bulb incl.: No

180103 Push/Pull Switch

 Voltage: 12
 Amp: 25
 Voltage 2: 24
 Amp 2: 12.5

 Neck: Short
 Mount. hole size: 8 mm

 Type/terminal: Screw
 Button colour: Black
 Switch: On/Off
 No./terminals w/screw: 2
 Illuminated: No

180104 Push/Pull Switch

 Voltage: 12
 Amp: 25
 Voltage 2: 24
 Amp 2: 12.5

 Neck: Long
 Mount. hole size: 8 mm

 Button colour: Black
 Switch: On/Off
 No./terminals w/screw: 2

181233 Push/Pull Switch

 Voltage: 12
 Amp: 25
 Voltage 2: 24
 Amp 2: 12.5

 Neck: Short
 Mount. hole size: 8 mm

 Type/terminal: Flat
 Button colour: Black
 Switch: On/Off
 Terminals: 2

PUSH BUTTON
180040 Push Button Switch
Rubber moulded boot on front.

 Voltage: 12
 Amp: 25
 Voltage 2: 24
 Amp 2: 12.5

Mount. hole size: 22.5 mm

 Switch: Off/(On)
 No./terminals w/screw: 2
 Moulded: Yes
 DIN norm: 72764

180047 Push Button Switch

Voltage: 12/24

Mount. hole size: 12.5 mm

 Button colour: Black
 Switch: Off/(On)
 No./terminals w/screw: 1









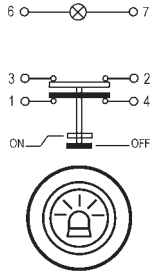

180049 Push Button Switch

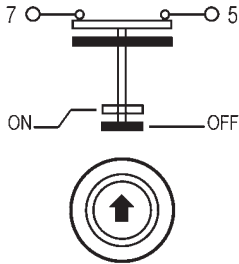
 Voltage: 12
 Amp: 25
 Voltage 2: 24
 Amp 2: 12.5

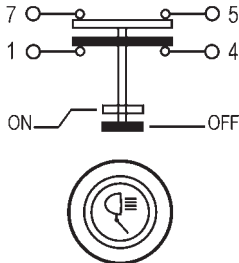
Mount. hole size: 22.5 mm

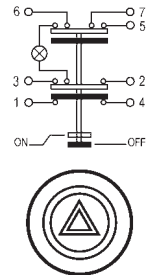
 Button colour: Black
 Switch: Off/(On)
 No./terminals w/screw: 2
 DIN norm: 72764

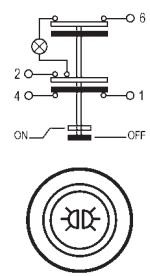
	EL. SPECIFICATIONS	DIMENSIONS	ADDITIONAL SPECIFICATIONS
180120 Push Button Switch 	Voltage: 12 Amp: 35 Voltage 2: 24 Amp 2: 17.5	Mount. hole size: 8.5 mm	Button colour: White Switch: Off/(On) Material: Metal No./terminals w/screw: 2 Silver contact: Yes
180121 Push Button Switch 	Voltage: 12 Amp: 25 Voltage 2: 24 Amp 2: 12.5	Mount. hole size: 22 mm	Button colour: Black Switch: Off/(On) Material: Metal No./terminals w/screw: 2 DIN norm: 72764
180215 Push Button Switch 	Voltage: 12 Amp: 25 Voltage 2: 24 Amp 2: 12.5	Mount. hole size: 22.5 mm	Switch: Off/(On) No./terminals w/screw: 2 Moulded: Yes Silver contact: Yes
180400 Push Button Switch Depth: 20 mm. 	Voltage: 12 Amp: 7 Voltage 2: 24 Amp 2: 3.5	Mount. hole size: 15.5 mm	Type/terminal: Screw Button colour: Black Switch: Off/(On) No./terminals w/screw: 2
SPARE PARTS			
181272 Rubber Boot Moulded.	Servicing: HC-CARGO 180049, 180040, 180215		
		OD: 28.3 mm Length: 18 mm	Colour: Black Material: Rubber
PUSH-PUSH			
180123 On/Off Switch 	Voltage: 12/24	Mount. hole size: 8 mm	Button colour: White Switch: On/Off No./terminals w/screw: 2
181564 Push Button Switch Illuminated ring. Vandal proof.   	Voltage: 12/24 Amp: <2 Voltage 2: 250 Amp 2: 3	Mount. hole size: 16 mm	Type/terminal: Solder Socket type: LED Colour: Red Switch: On/Off Material: Nickel plated brass Moulded: No Silver contact: Yes Protection degree: IP 67

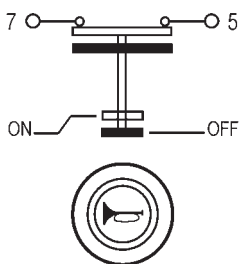
	EL. SPECIFICATIONS	DIMENSIONS	ADDITIONAL SPECIFICATIONS
181251 Push Switch  	Voltage: 12 Amp: 50 Voltage 2: 24 Amp 2: 25	Mount. hole size: 30.5 mm	Button symbol: Rotating beacon Switch: On/Off No./terminals w/screw: 6 Illuminated: Yes DIN norm: 40053 Protection degree: IP 67
181252 Push Switch  	Voltage: 12 Amp: 50 Voltage 2: 24 Amp 2: 25	Mount. hole size: 30.5 mm	Button symbol: Start Switch: On/Off No./terminals w/screw: 2 DIN norm: 40053 Protection degree: IP 67
181253 Push Switch  	Voltage: 12 Amp: 50 Voltage 2: 24 Amp 2: 25	Mount. hole size: 30.5 mm	Button symbol: Adjustable light Switch: On/Off No./terminals w/screw: 4 Illuminated: Yes DIN norm: 40053 Protection degree: IP 67
181256 Push Switch  	Voltage: 12 Amp: 50 Voltage 2: 24 Amp 2: 25	Mount. hole size: 30.5 mm	Button symbol: Hazard Warning Lamp Switch: On/Off No./terminals w/screw: 7 Illuminated: Yes Automatic return: Yes DIN norm: 40053 Protection degree: IP 67
181257 Push Switch  	Voltage: 12 Amp: 50 Voltage 2: 24 Amp 2: 25	Mount. hole size: 30.5 mm	Button symbol: Sidemarker Switch: On/Off No./terminals w/screw: 4 Illuminated: Yes DIN norm: 40053 Protection degree: IP 67
181258 Push Switch  	Voltage: 12 Amp: 50 Voltage 2: 24 Amp 2: 25	Mount. hole size: 30.5 mm	Button symbol: Horn Switch: On/Off No./terminals w/screw: 2 DIN norm: 40053 Protection degree: IP 67

181263 Push Switch

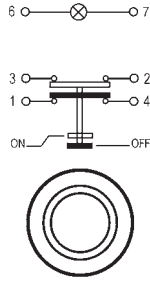

Voltage: 12
Amp: 50
Voltage 2: 24
Amp 2: 25

Mount. hole size: 30.5 mm

Switch: On/Off
No./terminals w/screw: 6
Illuminated: Yes
Automatic return: Yes
DIN norm: 40053
Protection degree: IP 67

181264 Multi Socket

Servicing: Renault - Visit www.hc-cargo.com for further information

For multi purpose switches.



Type/terminal: Flat
No./poles: 7

DOOR & BURGLAR ALARM

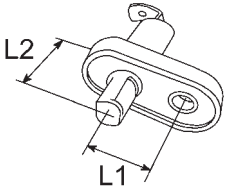

180254 Door Switch

Universal.



L1 dim.: 10-15 mm
L2 dim.: 0-20 mm
L2/self adjustable: Yes

Terminals: 1

180255 Door Switch

Universal.



L1 dim.: 10-15 mm
L2 dim.: 0-20 mm
L2/self adjustable: Yes

Terminals: 2

180261 Door Switch

For luggage compartment.



L1 dim.: 15 mm
L2 dim.: 49 mm
L2/self adjustable: Yes

Terminals: 1

180263 Door Switch

Servicing: Austin, Rover - Visit www.hc-cargo.com for further information



L1 dim.: 13 mm
L2 dim.: 15 mm

Terminals: 1

EL. SPECIFICATIONS	DIMENSIONS	ADDITIONAL SPECIFICATIONS
180265 Door Switch Servicing: Fiat, Seat - Visit www.hc-cargo.com for further information		
	L1 dim.: 12 mm L2 dim.: 9 mm	Terminals: 1
180266 Door Switch Servicing: Fiat Uno - Visit www.hc-cargo.com for further information		
	L1 dim.: 15 mm L2 dim.: 9 mm	Terminals: 2
180268 Door/Alarm Switch		
<i>Universal.</i>		
	L1 dim.: 11 mm L2 dim.: 22 mm Dist. mount. holes: 22 mm	Terminals: 1
180269 Door Switch		
<i>Universal.</i>		
	L1 dim.: 12 mm L2 dim.: 4.5 mm Dist. mount. holes: 22 mm	Terminals: 1
180529 Door Switch		
<i>Universal.</i>		
	L1 dim.: 14.5 mm L2 dim.: 12 mm Dist. mount. holes: 30 mm	Terminals: 2
180625 Door/Alarm Switch		
<i>Universal. Suitable for cutting to length.</i>		
	L1 dim.: 15 mm L2 dim.: 40 mm	Terminals: 1
JUNCTION BOXES		
191183 Junction Box		
	Length: 75 mm Height: 35 mm Width: 75 mm	Cable entries: 12 Connection block: No

191202 Junction Box

Length: 120 mm
Height: 36 mm
Width: 79 mm

Locking device: Mounting bracket
Material/house: Plastic
No./poles: 6
Cable entries: 4
Mount.: Screw
Waterproof: Yes
Dust proof: Yes

191203 Junction Box

Length: 120 mm
Height: 36 mm
Width: 79 mm

Type: Dual
Locking device: Mounting bracket
Material/house: Plastic
No./poles: 8
Cable entries: 4
Mount.: Terminal
Waterproof: Yes
Dust proof: Yes

191204 Junction Box

Length: 120 mm
Height: 36 mm
Width: 79 mm

Locking device: Mounting bracket
Material/house: Plastic
No./poles: 8
Cable entries: 4
Mount.: Screw
Waterproof: Yes
Dust proof: Yes

191205 Junction Box

Length: 120 mm
Height: 36 mm
Width: 79 mm

Locking device: Mounting bracket
Material/house: Plastic
No./poles: 12
Cable entries: 4
Mount.: Terminal
Waterproof: Yes
Dust proof: Yes

191206 Junction Box

Length: 120 mm
Height: 36 mm
Width: 79 mm

Locking device: Mounting bracket
Material/house: Plastic
No./poles: 12
Cable entries: 4
Mount.: Screw
Waterproof: Yes
Dust proof: Yes

191207 Junction Box

Length: 140 mm
Height: 47 mm
Width: 100 mm

Type: Dual
Locking device: Mounting bracket
Material/house: Plastic
No./poles: 12
Cable entries: 6
Mount.: Terminal
Waterproof: Yes
Dust proof: Yes

191208 Junction Box

Length: 145 mm
Height: 45 mm
Width: 100 mm

Locking device: Screw
Material/house: Plastic
No./poles: 24
Cable entries: 4
Mount.: Terminal
Waterproof: Yes
Dust proof: Yes

EL. SPECIFICATIONS	DIMENSIONS	ADDITIONAL SPECIFICATIONS
191209 Junction Box 	Length: 150 mm Height: 45 mm Width: 93 mm	Type: Dual Locking device: Mounting bracket Material/house: Plastic Material/lid: Aluminium No./poles: 8 Mount.: Terminal Waterproof: Yes Dust proof: Yes
191210 Junction Box 	Length: 120 mm Height: 30 mm Width: 69 mm	Locking device: Mounting bracket Material/house: Plastic Material/lid: Aluminium No./poles: 6 Mount.: Screw Waterproof: Yes Dust proof: Yes
191211 Junction Box <i>Cable entries and blind: HC-CARGO 191220, 191221, 191222, 191223.</i>		
	Length: 190 mm Height: 80 mm Width: 135 mm	Locking device: Mounting bracket Material/house: Plastic Material/lid: Aluminium Cable entries: 8 Waterproof: Yes Dust proof: Yes Connection block: No
191215 Junction Box <i>Cable entries and blind: HC-CARGO 191220, 191221, 191222, 191223. Connecting block: HC-CARGO 191212, 191213, 191214, 191218, 191219.</i>		
	Length: 151 mm Height: 55 mm Width: 93 mm	Locking device: Mounting bracket Material/house: Plastic Material/lid: Aluminium Cable entries: 5 Waterproof: Yes Dust proof: Yes Connection block: No
191216 Junction Box <i>Cable entries and blind: HC-CARGO 191220, 191221, 191222, 191223. Connecting block: HC-CARGO 191212, 191213, 191214, 191218, 191219.</i>		
	Length: 151 mm Height: 55 mm Width: 93 mm	Locking device: Mounting bracket Material/house: Plastic Material/lid: Aluminium Cable entries: 6 Waterproof: Yes Dust proof: Yes Connection block: No
191429 Junction Box 	Mount.: Screw Length: 127 mm Height: 41 mm Width: 108 mm	Colour: Transparent Material/house: Rubber Material/lid: Plastic No./poles: 8 Cable entries: 4 Waterproof: Yes Dust proof: Yes
191507 Junction Box 	Cable dim.: 6 mm ² Length: 125 mm Height: 25 mm Width: 73 mm	Material/house: Plastic No./poles: 6 Cable entries: 4 Mount.: Screw Waterproof: Yes Dust proof: Yes

191508 Junction Box

Cable dim.: 6 mm²
 Length: 125 mm
 Height: 25 mm
 Width: 73 mm

Material/house: Plastic
 No./poles: 8
 Cable entries: 4
 Mount.: Screw
 Waterproof: Yes
 Dust proof: Yes

191510 Junction Box

Cable dim.: 6 mm²
 Length: 125 mm
 Height: 25 mm
 Width: 73 mm

Type: Dual
 Material/house: Plastic
 No./poles: 8
 Cable entries: 4
 Mount.: Terminal
 Waterproof: Yes
 Dust proof: Yes

191755 Junction Box

Servicing: HC-CARGO 193011



Length: 105 mm
 Height: 66 mm
 Width: 105 mm

Colour: White
 Material/house: Plastic
 Waterproof: Yes
 Dust proof: Yes

191984 Junction Box

4 double 11 pole flat plug connection and 2 double 4 pole flat plug connection. w/ locking clamps or alternatively 4 screws.



Length: 167 mm
 Height: 99 mm
 Width: 157 mm

Material/house: Plastic
 Cable entries: 16
 Mount.: Terminal
 Waterproof: Yes
 ADR-approved: Yes
 GGVS approval: Yes
 Protection degree: IP 65

192218 Junction Box

Power junction box for cables up to 25 mm². Contains 2xM8 studs.



ACCESSORIES

191220 Cable Entries

Servicing: HC-CARGO 191211, 191215, 191216





O.D. 7 mm.

191221 Cable Entries

Servicing: HC-CARGO 191211, 191215, 191216

O.D. 9.5 mm.

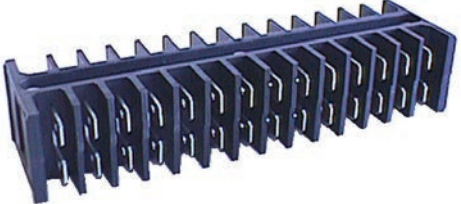
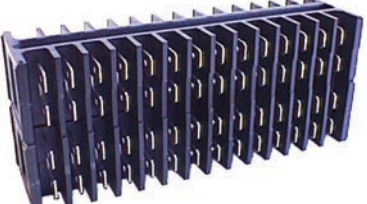
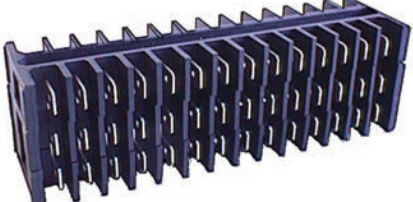

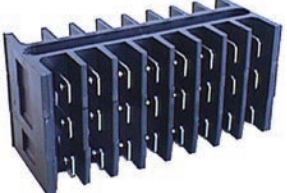
EL. SPECIFICATIONS	DIMENSIONS	ADDITIONAL SPECIFICATIONS
191222 Cable Entries Servicing: HC-CARGO 191211, 191215, 191216		
<i>O.D. 13 mm.</i>		
		
191223 Cable Entries Servicing: HC-CARGO 191211, 191215, 191216		
		
<h2>BLOCK</h2>		
191212 Terminal Block Servicing: HC-CARGO 191211		
		Type: Dual No./poles: 14 Mount.: Terminal
191213 Terminal Block Servicing: HC-CARGO 191211		
		Type: Dual No./poles: 28 Mount.: Terminal
191214 Terminal Block		
<i>1 double 14-pole and 1 single 14-pole flat plug connection block. Fits HC-CARGO 191211.</i>		
		Type: Dual No./poles: 14 Mount.: Terminal
191218 Terminal Block Servicing: HC-CARGO 191215, 191216		
		Type: Dual No./poles: 8 Mount.: Terminal
191219 Terminal Block Servicing: HC-CARGO 191215, -216		
<i>1 double 8-pole and 1 single 8-pole flat plug connection block. Fits HC-CARGO 191215 and 191216.</i>		
		Type: Dual No./poles: 8 Mount.: Terminal

191756 Butt Splices

Servicing: HC-CARGO 191755

8x6 terminalblock. 25 A.

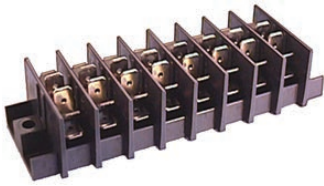

Dist. mount. holes: 99 mm
Width: 6.3 mm

Terminal type: Flat
Material: Polycarbonate
Out: 8
Plugs in: 8
Mount.: Terminal

191771 Butt Splices

1x8. For HC-CARGO 191755. 20 A.

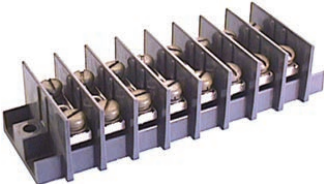

Dist. mount. holes: 99 mm

Terminal type: Screw
Material: Polycarbonate
Out: 8
Plugs in: 8
Mount.: Terminal

193011 Terminal Block

25 A.



Dist. mount. holes:
77.3 mm
Width: 6.3 mm

Terminal type: Flat
Material: Polycarbonate
Out: 6
Plugs in: 6

CABLE & WIRING

CABLE CLIPS

RUBBER-PROFILE

	HC-CARGO	Width	ID	Mount. hole size	Type	Material
	191666	12.7 mm	3.2 mm	6.8 mm	3	Rubber
	191667	12.7 mm	4.8 mm	6.8 mm	5	Rubber
	190899	12.7 mm	6.4 mm	6.8 mm	6	Rubber
	190900	12.7 mm	7.9 mm	6.8 mm	8	Rubber
	190901	12.7 mm	9.5 mm	6.8 mm	10	Rubber
	190902	12.7 mm	11.1 mm	6.8 mm	11	Rubber
	190903	12.7 mm	12.7 mm	6.8 mm	13	Rubber
	190904	12.7 mm	14.3 mm	6.8 mm	14	Rubber
	190905	12.7 mm	15.9 mm	6.8 mm	16	Rubber
	190906	12.7 mm	17.5 mm	6.8 mm	18	Rubber
	190907	12.7 mm	19 mm	6.8 mm	19	Rubber
	191668	12.7 mm	20.6 mm	6.8 mm	21	Rubber
	190908	12.7 mm	22.2 mm	6.8 mm	22	Rubber
	191669	12.7 mm	24 mm	6.8 mm	24	Rubber
	190909	12.7 mm	25.4 mm	6.8 mm	25	Rubber
	191991	12.7 mm	27 mm	6.8 mm	27	Rubber
	191417	12.7 mm	28.6 mm	6.8 mm	29	Rubber
	191992	12.7 mm	30.2 mm	6.8 mm	30	Rubber
	191994	12.7 mm	33.3 mm	6.8 mm	33	Rubber
	191553	12.7 mm	34.9 mm	6.8 mm	35	Rubber
	191996	12.7 mm	38.1 mm	6.8 mm	38	Rubber
	191997	12.7 mm	41 mm	6.8 mm	41	Rubber
	191998	12.7 mm	44.5 mm	6.8 mm	45	Rubber
	191814	12.7 mm	50.8 mm	6.8 mm	51	Rubber

SELF-ADHESIVE

	HC-CARGO	Cable dia.	
	190961	6 mm	Self-adhesive.
	190962	10 mm	Self-adhesive.

BLACK PLASTIC

	HC-CARGO	Length	ID	Mount. hole dia.	Colour
	191950	9.5 mm	3.2 mm	4.6 mm	Black
	191951	10.5 mm	4.8 mm	4.6 mm	Black
	191952	12 mm	6.4 mm	4.6 mm	Black
	191953	12 mm	7.9 mm	4.6 mm	Black
	191954	12.5 mm	9.5 mm	4.6 mm	Black
	191955	15.2 mm	12.7 mm	4.6 mm	Black
	191956	18.2 mm	15.8 mm	4.6 mm	Black
	191957	18.2 mm	19.4 mm	4.6 mm	Black
	191958	22 mm	25.4 mm	4.6 mm	Black
	191959	26.2 mm	31.8 mm	4.6 mm	Black

CHASSIS CLIPS

191228 Chassis Clips

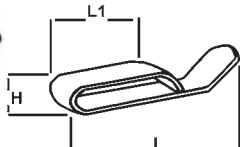

Length - L1: 22 mm
Total length - L: 43 mm
Height - H: 7 mm

191229 Chassis Clips

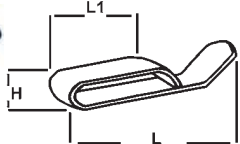

Length - L1: 31 mm
Total length - L: 52 mm
Height - H: 7 mm

193046 Chassis Clips

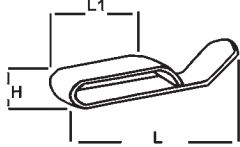

Length - L1: 15.5 mm
Total length - L: 28 mm
Height - H: 6 mm

PIPE CLIPS

	HC-CARGO	Cable dia.	Length	Width
	191230	3 mm	23.4 mm	15 mm
	191232	7 mm	17.5 mm	11.85 mm
	191233	8 mm	23.3 mm	10 mm
	191234	10 mm	24.9 mm	10 mm
	191235	12 mm	27.1 mm	11 mm
	191236	15 mm	31.5 mm	11 mm

CABLE TIES

BLACK

	HC-CARGO	Length	Width	Max width	Colour	Material
	191128	92 mm	2.4 mm	16 mm	Black	
	191003	102 mm	2.5 mm	25 mm	Black	Nylon 66
	191939	140 mm	2.5 mm	44 mm	Black	Nylon 66
	190188	150 mm	3.6 mm	39 mm	Black	Nylon 66
	190248	190 mm	4.8 mm	52 mm	Black	Nylon 66
	191094	200 mm	2.5 mm	55 mm	Black	Nylon 66
	192112	240 mm	7.6 mm	66 mm	Black	Nylon 66
	192110	292 mm	3.6 mm	85 mm	Black	Nylon 66
	190011	310 mm	4.8 mm	89 mm	Black	Nylon 66
	190190	368 mm	4.8 mm	102 mm	Black	Nylon 66
	190189	380 mm	7.6 mm	110 mm	Black	Nylon 66
	192068	450 mm	4.8 mm	130 mm	Black	Nylon 66
	191776	550 mm	8 mm	166 mm	Black	Nylon 66
	192041	730 mm	12.7 mm	225 mm	Black	Nylon 66
	190191	762 mm	9 mm	236 mm	Black	Nylon 66
192111	812 mm	9 mm	246 mm	Black	Nylon 66	

WHITE W/ MARKER PLATE

191940 Cable Tie

w/ marker plate.

 Length: 100 mm
 Width: 2.5 mm
 Max width: 25 mm

Colour: White

W/ LOCK

191942 Cable Tie

Releasable w/ lock.

 Length: 150 mm
 Width: 7.6 mm
 Max width: 30 mm

Colour: Black

191943 Cable Tie

Releasable w/ lock.

 Length: 300 mm
 Width: 8 mm
 Max width: 80 mm

Colour: Black

MOUNTING

	HC-CARGO	Length	Width	Max width	Mount. hole dia.
	192012	155 mm	3.7 mm	40 mm	4.8 mm
	192013	205 mm	4.2 mm	60 mm	4.8 mm
	192014	370 mm	4.8 mm	102 mm	4.8 mm
	192015	400 mm	7.9 mm	122 mm	4.8 mm

COLOURED

	HC-CARGO	Length	Width	Max width	Colour
	192494	190 mm	4.8 mm	52 mm	Red
	192495	190 mm	4.8 mm	52 mm	Blue
	192496	190 mm	4.8 mm	52 mm	Green
	192497	190 mm	4.8 mm	52 mm	Yellow
	192498	190 mm	4.8 mm	52 mm	White

TIE MOUNT

190014 Tie Mount

 Dim.: 27x27 mm
 Mount. hole dia.: 5 mm
 Max width: 5 mm

 Colour: Black
 Material: Nylon 66
 Self adhesive: Yes

191941 Tie Mount

 Dim.: 12.9x17.8x6.6 mm
 Mount. hole dia.: 6.2 mm
 Max width: 8 mm

 Colour: White
 Material: Nylon 66
 Self adhesive: No

EL. SPECIFICATIONS	DIMENSIONS	ADDITIONAL SPECIFICATIONS
191960 Tie Mount 	Dim.: 21x21 mm Mount. hole dia.: 5 mm Max width: 3.2 mm	Colour: Black Material: Nylon 66 Self adhesive: Yes
192489 Tie Mount 	Dim.: 16x15 mm Cable dia: 8 mm	Colour: White Material: Nylon 66 Self adhesive: Yes
192983 Tie Mount 	Dim.: 38x38 mm Mount. hole dia.: 5 mm Max width: 10 mm	Colour: Black Material: Nylon 66 Self adhesive: Yes
192985 Tie Mount <i>w/ 5 mm hole for screw mount.</i>		Dim.: 23x16x10 mm Mount. hole dia.: 5 mm Max width: 12 mm Colour: Black Material: Nylon Self adhesive: No
192997 Tie Mount 	Dim.: 26.1x26.1 mm Mount. hole dia.: 4.3 mm Max width: 8 mm	Colour: Black Material: Nylon Self adhesive: No
CHARGING CLIPS		
192196 Charging Clips 	Amp: 275 Cable dim.: 16 mm ²	Colour: Red Material: Moulded brass
192197 Charging Clips 	Amp: 275 Cable dim.: 16 mm ²	Colour: Black Material: Moulded brass

192293 Charging Clips

Length: 210 mm.



Amp: 420

 Cable dim.: 35-50 mm²

 Colour: Red
Material: PP/PVC

192294 Charging Clips

Length: 210 mm.



Amp: 420

 Cable dim.: 35-50 mm²

 Colour: Black
Material: PP/PVC

192386 Charging Clips

Amp: 275

 Cable dim.: 16 mm²

 Colour: Red
Material: Moulded brass

192387 Charging Clips

Amp: 275

 Cable dim.: 16 mm²

 Colour: Black
Material: Moulded brass

192388 Charging Clips

Amp: 320

 Cable dim.: 25 mm²

 Colour: Red
Material: Moulded brass

192389 Charging Clips

Amp: 320

 Cable dim.: 25 mm²

 Colour: Black
Material: Moulded brass

192390 Charging Clips

Amp: 420

 Cable dim.: 50 mm²

 Colour: Red
Material: Moulded brass

	EL. SPECIFICATIONS	DIMENSIONS	ADDITIONAL SPECIFICATIONS
192391 Charging Clips 	Amp: 420	Cable dim.: 50 mm ²	Colour: Black Material: Moulded brass
192903 	Amp: 1200	Cable dim.: 25-50 mm ²	Colour: Red Material: Brass
192904 	Amp: 1200	Cable dim.: 25-50 mm ²	Colour: Black Material: Brass
FULLY INSULATED			
192204 	Amp: 600	Cable dim.: 25-50 mm ²	Colour: Red Material: Compressed steel Fully insulated: Yes Braided link: w/
192205 	Amp: 600	Cable dim.: 25-50 mm ²	Colour: Black Material: Compressed steel Fully insulated: Yes Braided link: w/
192398 Charging Clips 	Amp: 600	Cable dim.: 50 mm ²	Colour: Red Material: Copper/Brass Fully insulated: Yes Braided link: w/
192399 Charging Clips 	Amp: 600	Cable dim.: 50 mm ²	Colour: Black Material: Copper/Brass Fully insulated: Yes Braided link: w/

192559 Charging Clips 500 A

Ergonomic.

Amp: 500

 Cable dim.: 25-50 mm²

 Colour: Red
 Material: Moulded brass
 Fully insulated: Yes

192560 Charging Clips 500 A

Ergonomic.

Amp: 500

 Cable dim.: 25-50 mm²

 Colour: Black
 Material: Moulded brass
 Fully insulated: Yes

ALLIGATOR AND UNIVERSAL CLIPS
ALLIGATOR
192190 Alligator Clip

Amp: 5

 Jaw opening: 11
 Length: 50 mm

192191 Alligator Clip

Amp: 40

 Jaw opening: 14
 Length: 75 mm

 Type: Positive
 Colour: Red

192192 Alligator Clip

Amp: 40

 Jaw opening: 14
 Length: 75 mm

 Type: Negative
 Colour: Black

192659 Alligator Clip

Ohm: 10

 Jaw opening: 11
 Length: 80 mm

 Type: Positive
 Colour: Red

192660 Alligator Clip

Ohm: 10

 Jaw opening: 11
 Length: 80 mm

 Type: Negative
 Colour: Black

UNIVERSAL
192700 Universal Clips

Amp: 25

 Jaw opening: 19
Length: 70 mm

Type: Positive

192701 Universal Clips

Amp: 25

 Jaw opening: 19
Length: 70 mm

Type: Negative

192702 Universal Clips

Amp: 50

 Jaw opening: 25
Length: 100 mm

Type: Positive

192703 Universal Clips

Amp: 50

 Jaw opening: 25
Length: 100 mm

Type: Negative

193239 Universal Clips

Amp: 25

 Jaw opening: 12
Length: 75 mm

Type: Positive

193240 Universal Clips

Amp: 25

 Jaw opening: 12
Length: 75 mm

Type: Negative

CONNECTORS

	HC-CARGO	Size 1	Size 2	Size 3	Temp.	Colour	Material	Type
	193164	7.5 mm	7.5 mm	7.5 mm	-40 - +135 °C	Black	Polyamid	T
	193152	10 mm	7.5 mm	7.5 mm	-40 - +135 °C	Black	Polyamid	T
	193128	10 mm	7.5 mm	10 mm	-40 - +135 °C	Black	Polyamid	T
	193129	10 mm	10 mm	10 mm	-40 - +135 °C	Black	Polyamid	T
	193130	13 mm	7.5 mm	13 mm	-40 - +135 °C	Black	Polyamid	T
	193153	13 mm	10 mm	10 mm	-40 - +135 °C	Black	Polyamid	T
	193131	13 mm	10 mm	13 mm	-40 - +135 °C	Black	Polyamid	T
	193151	13 mm	13 mm	13 mm	-40 - +135 °C	Black	Polyamid	T
	193132	17 mm	7.5 mm	13 mm	-40 - +135 °C	Black	Polyamid	T
	193133	17 mm	7.5 mm	17 mm	-40 - +135 °C	Black	Polyamid	T
	193134	17 mm	10 mm	13 mm	-40 - +135 °C	Black	Polyamid	T
	193135	17 mm	10 mm	17 mm	-40 - +135 °C	Black	Polyamid	T
	193136	17 mm	13 mm	13 mm	-40 - +135 °C	Black	Polyamid	T
	193137	17 mm	13 mm	17 mm	-40 - +135 °C	Black	Polyamid	T
	193212	17 mm	17 mm	17 mm	-40 - +135 °C	Black	Polyamid	T
	193138	17 mm	22 mm	17 mm	-40 - +135 °C	Black	Polyamid	T
	193165	22 mm	7.5 mm	22 mm	-40 - +135 °C	Black	Polyamid	T
	193139	22 mm	10 mm	10 mm	-40 - +135 °C	Black	Polyamid	T
	193140	22 mm	10 mm	22 mm	-40 - +135 °C	Black	Polyamid	T
	193141	22 mm	13 mm	17 mm	-40 - +135 °C	Black	Polyamid	T
	193142	22 mm	13 mm	22 mm	-40 - +135 °C	Black	Polyamid	T
	193143	22 mm	17 mm	13 mm	-40 - +135 °C	Black	Polyamid	T
	193144	22 mm	22 mm	22 mm	-40 - +135 °C	Black	Polyamid	T
	193145	26 mm	10 mm	26 mm	-40 - +135 °C	Black	Polyamid	T
	193146	26 mm	13 mm	22 mm	-40 - +135 °C	Black	Polyamid	T
	193147	26 mm	13 mm	26 mm	-40 - +135 °C	Black	Polyamid	T
193148	26 mm	17 mm	17 mm	-40 - +135 °C	Black	Polyamid	T	
193149	26 mm	17 mm	22 mm	-40 - +135 °C	Black	Polyamid	T	
193150	26 mm	26 mm	26 mm	-40 - +135 °C	Black	Polyamid	T	

	HC-CARGO	Size 1	Size 2	Size 3	Temp.	Colour	Material	Type
	193154	17 mm	13 mm	17 mm	-40 - +135 °C	Black	Polyamid	Y
	193155	22 mm	10 mm	17 mm	-40 - +135 °C	Black	Polyamid	Y
	193156	22 mm	13 mm	17 mm	-40 - +135 °C	Black	Polyamid	Y
	193157	13 mm	7.5 mm	10 mm	-40 - +135 °C	Black	Polyamid	Y
	193158	13 mm	10 mm	10 mm	-40 - +135 °C	Black	Polyamid	Y
	193159	13 mm	10 mm	13 mm	-40 - +135 °C	Black	Polyamid	Y
	193160	13 mm	13 mm	13 mm	-40 - +135 °C	Black	Polyamid	Y
	193161	17 mm	13 mm	10 mm	-40 - +135 °C	Black	Polyamid	Y
	193162	26 mm	22 mm	22 mm	-40 - +135 °C	Black	Polyamid	Y
	193163	10 mm	10 mm	10 mm	-40 - +135 °C	Black	Polyamid	Y

FLEXIBLE CONVOLUTED TUBING

	HC-CARGO	ID	OD	Length	ISO Norm	Colour	Material
	193121	6.6 mm	10 mm	50 m	9772 9773	Black	Nylon 66
	193122	9.8 mm	13 mm	50 m	9772 9773	Black	Nylon 66
	193123	12.2 mm	15.8 mm	50 m	9772 9773	Black	Nylon 66
	193124	17.2 mm	20 mm	100 m		Black	Polypropylene
	193125	21.2 mm	25.8 mm	100 m		Black	Polypropylene
	193126	25 mm	30 mm	50 m		Black	Polypropylene
	193127	28 mm	34 mm	50 m		Black	Polypropylene

FLEXIBLE CONVOLUTED SPLIT TUBING

	HC-CARGO	Cable dim.	Length	Colour	Material
	191944	7.4/10.2 mm ²	25 m	Black	Polypropylene
	B191944	7.4/10.2 mm ²	300 m	Black	Polypropylene
	191945	10.7/14.1 mm ²	25 m	Black	Polypropylene
	B191945	10.7/14.1 mm ²	200 m	Black	Polypropylene
	191946	13.2/17.5 mm ²	25 m	Black	Polypropylene
	B191946	13.2/17.5 mm ²	200 m	Black	Polypropylene
	191947	15.00/19.50 mm ²	10 m	Black	Polypropylene
	B191947	15.00/19.50 mm ²	100 m	Black	Polypropylene
	191948	19.3/23.8 mm ²	10 m	Black	Polypropylene
	B191948	19.3/23.8 mm ²	100 m	Black	Polypropylene
	191949	22/27 mm ²	10 m	Black	Polypropylene
	B191949	22/27 mm ²	100 m	Black	Polypropylene
	192009	25/30 mm ²	10 m	Black	Polypropylene
	B192009	25/30 mm ²	50 m	Black	Polypropylene
	192010	28/34 mm ²	10 m	Black	Polypropylene
	B192010	28/34 mm ²	50 m	Black	Polypropylene

GLANDS

192355 Cable Gland



Cable dia: 3.5 mm
ID: 6.9 mm
Mount. hole dia.:
12.1 mm
Length: 41.2 mm
Max width: 6 mm

Colour: Grey
Protection degree: IP 68

192356 Cable Gland



Cable dia: 4 mm
ID: 8 mm
Mount. hole dia.:
14.3 mm
Length: 45 mm
Max width: 8 mm

Colour: Grey
Protection degree: IP 68

192357 Cable Gland



Cable dia: 5 mm
ID: 10.5 mm
Mount. hole dia.:
18.23 mm
Length: 49.9 mm
Max width: 10 mm

Colour: Grey
Protection degree: IP 68

192358 Cable Gland



Cable dia: 6 mm
ID: 12 mm
Mount. hole dia.:
19.9 mm
Length: 52.4 mm
Max width: 12 mm

Colour: Grey
Protection degree: IP 68

192359 Cable Gland



Cable dia: 10 mm
ID: 14 mm
Mount. hole dia.:
22.1 mm
Length: 55.5 mm
Max width: 14 mm

Colour: Grey
Protection degree: IP 68

192360 Cable Gland			
		Cable dia: 13 mm ID: 18.4 mm Mount. hole dia.: 27.5 mm Length: 64.5 mm Max width: 18 mm	Colour: Grey Protection degree: IP 68
192479 Cable Gland			
		Cable dia: 3 mm ID: 6.9 mm Mount. hole dia.: 12 mm Length: 41.7 mm Max width: 6.5 mm	Colour: Grey Protection degree: IP 68
192480 Cable Gland			
		Cable dia: 5 mm ID: 10.5 mm Mount. hole dia.: 16 mm Length: 55.8 mm Max width: 10 mm	Colour: Grey Protection degree: IP 68
192481 Cable Gland			
		Cable dia: 10 mm ID: 14 mm Mount. hole dia.: 20 mm Length: 62 mm Max width: 14 mm	Colour: Grey Protection degree: IP 68
192482 Cable Gland			
		Cable dia: 13 mm ID: 18.4 mm Mount. hole dia.: 25 mm Length: 66.9 mm Max width: 18 mm	Colour: Grey Protection degree: IP 68
192483 Cable Gland			
		Cable dia: 18 mm ID: 25 mm Mount. hole dia.: 32 mm Length: 74.9 mm Max width: 25 mm	Colour: Grey Protection degree: IP 68

GROMMET

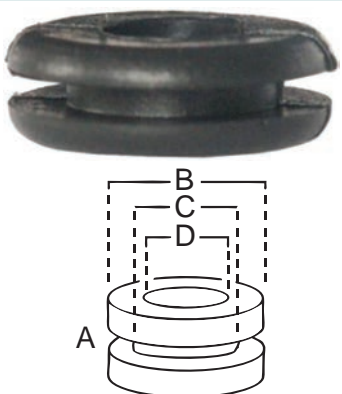
	HC-CARGO	A	B	C	D	Colour	Material
	190120	1.6 mm	14.2 mm	9.5 mm	6.4 mm	Black	PVC
	190122	1.6 mm	17 mm	12.5 mm	9.5 mm	Black	PVC
	190964	1.6 mm	11.1 mm	7.9 mm	5.6 mm	Black	PVC
	190965	1.6 mm	14.2 mm	9.5 mm	8 mm	Black	PVC
	190966	1.6 mm	14.2 mm	11 mm	8 mm	Black	PVC
	190967	1.6 mm	16 mm	11 mm	8 mm	Black	PVC
	190968	1.6 mm	19 mm	14.2 mm	11 mm	Black	PVC
	190969	1.6 mm	22 mm	17.5 mm	12.5 mm	Black	PVC
	190970	1.6 mm	25.5 mm	19 mm	12.5 mm	Black	PVC
	192138	3 mm	16 mm	12.5 mm	8 mm	Black	PVC
	192139	3 mm	30 mm	24 mm	16 mm	Black	PVC

END PLUG

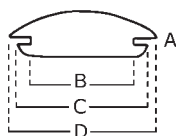

HC-CARGO	A	B	C	D	Colour	Material
190110	1.6 mm	6.4 mm	9.5 mm	9.5 mm	Black	PVC
190111	1.6 mm	8 mm	10.6 mm	14.2 mm	Black	PVC
190112	1.6 mm	9.5 mm	12.8 mm	15.4 mm	Black	PVC
190114	1.6 mm	12.5 mm	15.5 mm	18.7 mm	Black	PVC
190115	1.6 mm	15.5 mm	19 mm	22 mm	Black	PVC
190116	1.6 mm	19 mm	22.1 mm	25.5 mm	Black	PVC
190958	1.6 mm	22.5 mm	27 mm	28.5 mm	Black	PVC
190959	1.6 mm	25.4 mm	28.3 mm	32 mm	Black	PVC

POLYURETHAN WIRE SLEEVING



HC-CARGO	Voltage	ID	Length	Temp. resistant	Thermal class.	Colour
191380	4000	1 mm	1 m	+ 155°C	F	Nature
B191380	4000	1 mm	200 m	+ 155°C	F	Nature
B191382	4000	2 mm	200 m	+ 155°C	F	Nature
191383	4000	2.5 mm	1 m	+ 155°C	F	Nature
B191383	4000	2.5 mm	200 m	+ 155°C	F	Nature
191384	4000	3 mm	1 m	+ 155°C	F	Nature
B191384	4000	3 mm	100 m	+ 155°C	F	Nature
B191385	4000	4 mm	100 m	+ 155°C	F	Nature
191387	4000	6 mm	1 m	+ 155°C	F	Nature
B191387	4000	6 mm	100 m	+ 155°C	F	Nature
B191386	4000	7 mm	100 m	+ 155°C	F	Nature
191494	4000	8 mm	1 m	+ 155°C	F	Nature
B191494	4000	8 mm	100 m	+ 155°C	F	Nature

PVC SLEEVINGS



HC-CARGO	Cable dim.	Colour	Material
190175	4 mm ²	Black	PVC
191388	5 mm ²	Black	PVC
190176	6 mm ²	Black	PVC
190177	8 mm ²	Black	PVC
190178	10 mm ²	Black	PVC
190179	12 mm ²	Black	PVC

SPIRAL BINDINGS



HC-CARGO	Recommended loom	Length	Temp	Colour
191881	2 mm - 10 mm	50 m	-50 - +85 °C	Black
191882	5 mm - 40 mm	25 m	-50 - +85 °C	Black
191883	10 mm - 50 mm	25 m	-50 - +85 °C	Black

HEAT SHRINK TUBING

BLACK



HC-CARGO	Crimp ratio	Crimp temp	Before crimp	After crimp	Length	Dim.	Packaging	Colour
192513	2:1	70 °C	1.6 mm	0.8 mm	12 m	17x17x5.5 cm	Minibox	Black
193169	2:1	90 °C	1.6 mm	0.8 mm	10 m	16x16x5 cm	Minibox	Black
193170	2:1	90 °C	2.4 mm	1.2 mm	10 m	16x16x5 cm	Minibox	Black
193171	2:1	90 °C	3.2 mm	1.6 mm	10 m	16x16x5 cm	Minibox	Black
193172	2:1	90 °C	4.8 mm	2.4 mm	8 m	16x16x5 cm	Minibox	Black
193173	2:1	90 °C	6.4 mm	3.2 mm	6 m	16x16x5 cm	Minibox	Black
193174	2:1	90 °C	9.5 mm	4.7 mm	5 m	16x16x5 cm	Minibox	Black
193175	2:1	90 °C	12.7 mm	6.4 mm	5 m	16x16x5 cm	Minibox	Black
193176	2:1	90 °C	19.1 mm	9.5 mm	4 m	16x16x5 cm	Minibox	Black
193177	2:1	90 °C	25.4 mm	12.7 mm	3 m	16x16x5 cm	Minibox	Black
193178	2:1	90 °C	31.8 mm	15.9 mm	1 m		Plastic bag	Black
193179	2:1	90 °C	38.1 mm	19.1 mm	1 m		Plastic bag	Black
193180	2:1	90 °C	50.8 mm	25.4 mm	1 m		Plastic bag	Black

RED

	HC-CARGO	Crimp ratio	Crimp temp	Before crimp	After crimp	Length	Dim.	Packaging	Colour
	192625	2:1	70 °C	3.2 mm	1.6 mm	11.5 m	17x17x5.5 cm	Minibox	Red
	193181	2:1	90 °C	3.2 mm	1.6 mm	10 m	16x16x5 cm	Minibox	Red
	193182	2:1	90 °C	4.8 mm	2.4 mm	8 m	16x16x5 cm	Minibox	Red
	193183	2:1	90 °C	6.4 mm	3.2 mm	6 m	16x16x5 cm	Minibox	Red
	193184	2:1	90 °C	9.5 mm	4.7 mm	5 m	16x16x5 cm	Minibox	Red
	193185	2:1	90 °C	12.7 mm	6.4 mm	5 m	16x16x5 cm	Minibox	Red
	193186	2:1	90 °C	19.1 mm	9.5 mm	4 m	16x16x5 cm	Minibox	Red
	193187	2:1	90 °C	25.4 mm	12.7 mm	3 m	16x16x5 cm	Minibox	Red
	193188	2:1	90 °C	31.8 mm	15.9 mm	1 m		Plastic bag	Red
	193189	2:1	90 °C	38.1 mm	19.1 mm	1 m		Plastic bag	Red
193190	2:1	90 °C	50.8 mm	25.4 mm	1 m		Plastic bag	Red	

BLACK - BLISTER PACK

	HC-CARGO	Crimp ratio	Crimp temp	Before crimp	After crimp	Length	Dim.	Packaging	Colour
	193003	2:1	110 °C	2.4 mm	1.2 mm	2 m		Blister pack	Black
	193004	2:1	110 °C	3.2 mm	1.6 mm	2 m		Blister pack	Black
	193005	2:1	110 °C	4.8 mm	2.4 mm	2 m		Blister pack	Black
	193006	2:1	110 °C	6.4 mm	3.2 mm	2 m		Blister pack	Black
	193007	2:1	110 °C	9.5 mm	4.8 mm	2 m		Blister pack	Black
	193008	2:1	110 °C	12.7 mm	6.4 mm	2 m		Blister pack	Black
	193009	2:1	110 °C	19 mm	9.5 mm	2 m		Blister pack	Black

BLACK W/ GLUE

	HC-CARGO	Crimp ratio	Crimp temp	Before crimp	After crimp	Length	Dim.	Packaging	Colour
	193191	3:1	100 °C	3 mm	1 mm	5x0.2 m		Plastic bag	Black
	193197	3:1	100 °C	3 mm	1 mm	5 m	16x16x5 cm	Minibox	Black
	193192	3:1	100 °C	6 mm	2 mm	5x0.2 m		Plastic bag	Black
	193198	3:1	100 °C	6 mm	2 mm	3.5 m	16x16x5 cm	Minibox	Black
	193193	3:1	100 °C	9 mm	3 mm	5x0.2 m		Plastic bag	Black
	193199	3:1	100 °C	9 mm	3 mm	3 m	16x16x5 cm	Minibox	Black
	193194	3:1	100 °C	12 mm	4 mm	5x0.2 m		Plastic bag	Black
	193200	3:1	100 °C	12 mm	4 mm	2.5 m	16x16x5 cm	Minibox	Black
	193195	3:1	100 °C	18 mm	6 mm	5x0.2 m		Plastic bag	Black
	193201	3:1	100 °C	18 mm	6 mm	2 m	16x16x5 cm	Minibox	Black
	193196	3:1	100 °C	24 mm	8 mm	5x0.2 m		Plastic bag	Black
	193202	3:1	100 °C	24 mm	8 mm	1.5 m	16x16x5 cm	Minibox	Black
	193203	3:1	100 °C	39 mm	13 mm	1 m		Plastic bag	Black
	193204	4:1	100 °C	52 mm	13 mm	1 m		Plastic bag	Black

RED W/ GLUE

	HC-CARGO	Crimp ratio	Crimp temp	Before crimp	After crimp	Length	Dim.	Packaging	Colour
	193205	3:1	100 °C	3 mm	1 mm	5 m	16x16x5 cm	Minibox	Red
	193206	3:1	100 °C	6 mm	2 mm	3.5 m	16x16x5 cm	Minibox	Red
	193207	3:1	100 °C	9 mm	3 mm	3 m	16x16x5 cm	Minibox	Red
	193208	3:1	100 °C	12 mm	4 mm	2.5 m	16x16x5 cm	Minibox	Red
	193209	3:1	100 °C	18 mm	6 mm	2 m	16x16x5 cm	Minibox	Red
	193210	3:1	100 °C	24 mm	8 mm	1.5 m	16x16x5 cm	Minibox	Red
	193211	3:1	100 °C	39 mm	13 mm	1.22 m		Plastic bag	Red

TOOLS½

CABLE CUTTER

211096 Cable Cutter

Cutting size O.D. 50 mm².



CABLE STRIPPER

210828 Cable Stripper

Self-adjusting.



Cable dia: 0.5-8 mm
Max width: 5 mm

CABLE TIE GUNS

210827 Cable Tie Gun

Professional, adjustable, fasten and cut ties automatically.



Dim.: 2.5-5 mm
Cable dia: 2.5-5 mm
Max width: 4.8 mm

210849 Cable Tie Gun

Professional, adjustable, fasten and cut ties automatically.



Dim.: 2.5-10 mm
Cable dia: 2.5-10 mm
Max width: 10 mm

BUSHES

210644 Dismounting Bushes

Servicing: HC-CARGO 210643



OD: 6.5 mm

210645 Contact Insertion Sleeve

Servicing: HC-CARGO 210643



Dim.: 6.5 mm²

CABLES

SINGLE CORE

0.5 mm²

HC-CARGO	Voltage	Amp	Conductor dim.	OD	Temp. area	Insulator	Colour	Material	Type	Min supply
191930	300/500	5	16/0.195 mm	2.5 mm	70 °C	Unleaded PVC	Brown	PVC	H05V-K	100 m
191936	300/500	5	16/0.195 mm	2.5 mm	70 °C	Unleaded PVC	Grey	PVC	H05V-K	100 m

0.75 mm²

HC-CARGO	Voltage	Amp	Conductor dim.	OD	Temp. area	Insulator	Colour	Material	Type	Min supply
190674	50	10	24/0.195 mm	2.8 mm	70 °C	Unleaded PVC	Black	PVC	Round	100 m
191395	50	10	24/0.195 mm	2.8 mm	70 °C	Unleaded PVC	Blue	PVC	Round	100 m
191396	50	10	24/0.195 mm	2.8 mm	70 °C	Unleaded PVC	Brown	PVC	Round	100 m
191396Z	300/500	10	24/0.195 mm	2.7 mm	70 °C	Unleaded PVC	Brown	PVC	H05V2-K	100 m
191397	50	10	24/0.195 mm	2.8 mm	70 °C	Unleaded PVC	Green	PVC	Round	100 m
191398	50	10	24/0.195 mm	2.8 mm	70 °C	Unleaded PVC	Yellow	PVC	Round	100 m
191399	50	10	24/0.195 mm	2.8 mm	70 °C	Unleaded PVC	White	PVC	Round	100 m
191400	50	10	24/0.195 mm	2.8 mm	70 °C	Unleaded PVC	Red	PVC	Round	100 m
191401	50	10	24/0.195 mm	2.8 mm	70 °C	Unleaded PVC	Grey	PVC	Round	100 m
191402	300/500	6	24/0.195 mm	2.7 mm	70 °C	Unleaded PVC	Purple	PVC	H05V2-K	100 m
191403	300/500	10	24/0.195 mm	2.7 mm	70 °C	Unleaded PVC	Orange	PVC	H05V-K	100 m
192275	100	6	24/0.19 mm	2 mm	-40 - +100 °C	ISO 6722, Class B	Red/black	PVC	Round	100 m
192276	100	6	24/0.19 mm	2 mm	-40 - +100 °C	ISO 6722, Class B	Red/Blue	PVC	Round	100 m
192277	100	6	24/0.19 mm	2 mm	-40 - +100 °C	ISO 6722, Class B	Red/yellow	PVC	Round	100 m
192278	100	6	24/0.19 mm	2 mm	-40 - +100 °C	ISO 6722, Class B	Yellow/green	PVC	Round	100 m
192279	100	6	24/0.19 mm	2 mm	-40 - +100 °C	ISO 6722, Class B	Grey/red	PVC	Round	100 m
192280	100	6	24/0.19 mm	2 mm	-40 - +100 °C	ISO 6722, Class B	Black/white	PVC	Round	100 m
192282	100	6	24/0.19 mm	2 mm	-40 - +100 °C	ISO 6722, Class B	Blue/green	PVC	Round	100 m
192283	100	6	24/0.19 mm	2 mm	-40 - +100 °C	ISO 6722, Class B	Black/yellow	PVC	Round	100 m
192284	100	6	24/0.19 mm	2 mm	-40 - +100 °C	ISO 6722, Class B	White/blue	PVC	Round	100 m
192286	100	6	24/0.19 mm	2 mm	-40 - +100 °C	ISO 6722, Class B	White/green	PVC	Round	100 m
192287	100	6	24/0.19 mm	2 mm	-40 - +100 °C	ISO 6722, Class B	White/yellow	PVC	Round	100 m
192288	100	6	24/0.19 mm	2 mm	-40 - +100 °C	ISO 6722, Class B	White/red	PVC	Round	100 m

1 mm²

HC-CARGO	Voltage	Amp	Conductor dim.	OD	Temp. area	Insulator	Colour	Material	Type	Min supply
190987	50	10	32/0.195 mm	2.8 mm	70 °C	Unleaded PVC	Yellow	PVC	Round	100 m
190988	50	10	32/0.195 mm	2.8 mm	70 °C	Unleaded PVC	Green	PVC	Round	100 m
191090	50	10	32/0.195 mm	2.8 mm	70 °C	Unleaded PVC	Grey	PVC	Round	100 m
191404	50	10	32/0.195 mm	2.8 mm	70 °C	Unleaded PVC	Purple	PVC	Round	100 m

1 mm², H05V-K

HC-CARGO	Voltage	Amp	Conductor dim.	OD	Temp. area	Insulator	Colour	Material	Type	Min supply
190986	300/500	14	32/0.195 mm	2.8 mm	70 °C	Unleaded PVC	Black	PVC	H05V-K	100 m
190989	300/500	14	32/0.195 mm	2.8 mm	70 °C	Unleaded PVC	Blue	PVC	H05V-K	100 m
190990	300/500	14	32/0.195 mm	2.8 mm	70 °C	Unleaded PVC	Red	PVC	H05V-K	100 m
190991	300/500	14	32/0.195 mm	2.8 mm	70 °C	Unleaded PVC	White	PVC	H05V-K	100 m
190992	300/500	14	32/0.195 mm	2.8 mm	70 °C	Unleaded PVC	Brown	PVC	H05V-K	100 m

1.5 mm²

HC-CARGO	Voltage	Amp	Conductor dim.	OD	Temp. area	Insulator	Colour	Material	Type	Min supply
190696	50	18	30/0.250 mm	3 mm	70 °C	Unleaded PVC	White	PVC	Round	100 m
190697	50	18	30/0.250 mm	3 mm	70 °C	Unleaded PVC	Black	PVC	Round	100 m
190697Z	450/750	16	30/0.250 mm	3 mm	70 °C	Unleaded PVC	Black	PVC	H07V2-K	100 m
190698	50	18	30/0.250 mm	3 mm	70 °C	Unleaded PVC	Red	PVC	Round	100 m
190699	50	18	30/0.250 mm	3 mm	70 °C	Unleaded PVC	Blue	PVC	Round	100 m

HC-CARGO	Voltage	Amp	Conductor dim.	OD	Temp. area	Insulator	Colour	Material	Type	Min supply
190700	50	18	30/0.250 mm	3 mm	70 °C	Unleaded PVC	Yellow	PVC	Round	100 m
190701	50	18	30/0.250 mm	3 mm	70 °C	Unleaded PVC	Grey	PVC	Round	100 m
190702	50	18	30/0.250 mm	3 mm	70 °C	Unleaded PVC	Green	PVC	Round	100 m
190847	50	18	30/0.250 mm	3 mm	70 °C	Unleaded PVC	Brown	PVC	Round	100 m
192289	50	16	30/0.250 mm	3 mm	70 °C	Unleaded PVC	Orange	PVC	Round	100 m
191176	100	16	27-30/0.25 mm	2.7 mm	-40 - +100 °C	ISO 6722, Class B	White/red	PVC R2G4	Round	100 m
191177	100	16	27-30/0.25 mm	2.7 mm	-40 - +100 °C	ISO 6722, Class B	Yellow/blue	PVC R2G4	Round	100 m
191178	100	16	27-30/0.25 mm	2.7 mm	-40 - +100 °C	ISO 6722, Class B	Brown/blue	PVC R2G4	Round	100 m
192259	100	16	27-30/0.25 mm	2.7 mm	-40 - +100 °C	ISO 6722, Class B	Yellow/black	PVC R2G4	Round	100 m
192260	100	16	27-30/0.25 mm	2.7 mm	-40 - +100 °C	ISO 6722, Class B	Red/Blue	PVC R2G4	Round	100 m
192261	100	16	27-30/0.25 mm	2.7 mm	-40 - +100 °C	ISO 6722, Class B	Green/red	PVC R2G4	Round	100 m
192262	100	16	27-30/0.25 mm	2.7 mm	-40 - +100 °C	ISO 6722, Class B	Grey/red	PVC R2G4	Round	100 m
192263	100	16	27-30/0.25 mm	2.7 mm	-40 - +100 °C	ISO 6722, Class B	White/blue	PVC R2G4	Round	100 m
192264	100	16	27-30/0.25 mm	2.7 mm	-40 - +100 °C	ISO 6722, Class B	Green/yellow	PVC R2G4	Round	100 m
192265	100	16	27-30/0.25 mm	2.7 mm	-40 - +100 °C	ISO 6722, Class B	Brown/black	PVC R2G4	Round	100 m
192267	100	16	27-30/0.25 mm	2.7 mm	-40 - +100 °C	ISO 6722, Class B	Black/red	PVC R2G4	Round	100 m
192269	100	16	27-30/0.25 mm	2.7 mm	-40 - +100 °C	ISO 6722, Class B	Black/green	PVC R2G4	Round	100 m
192270	100	16	27-30/0.25 mm	2.7 mm	-40 - +100 °C	ISO 6722, Class B	Black/blue	PVC R2G4	Round	100 m
192271	100	16	27-30/0.25 mm	2.7 mm	-40 - +100 °C	ISO 6722, Class B	Black/orange	PVC R2G4	Round	100 m
192272	100	16	27-30/0.25 mm	2.7 mm	-40 - +100 °C	ISO 6722, Class B	White/black	PVC R2G4	Round	100 m
192273	100	16	27-30/0.25 mm	2.7 mm	-40 - +100 °C	ISO 6722, Class B	White/orange	PVC R2G4	Round	100 m
192274	100	16	27-30/0.25 mm	2.7 mm	-40 - +100 °C	ISO 6722, Class B	White/green	PVC R2G4	Round	100 m

2.5 mm²

HC-CARGO	Voltage	Amp	Conductor dim.	OD	Temp. area	Insulator	Colour	Material	Type	Min supply
190703	50	24	50/0.250 mm	3.5 mm	70 °C	Unleaded PVC	Black	PVC	Round	50 m
190703Z	450/750	25	50/0.250 mm	3.7 mm	70 °C	Unleaded PVC	Black	PVC	H07V-K	100 m
190704	50	24	50/0.250 mm	3.5 mm	70 °C	Unleaded PVC	Red	PVC	Round	50 m
190704Z	450/750	25	50/0.250 mm	3.7 mm	70 °C	Unleaded PVC	Red	PVC	H07V-K	100 m
190705	50	24	50/0.250 mm	3.5 mm	70 °C	Unleaded PVC	Blue	PVC	Round	50 m
190706	50	24	50/0.250 mm	3.5 mm	70 °C	Unleaded PVC	Yellow	PVC	Round	50 m
190707	450/750	25	50/0.250 mm	3.7 mm	70 °C	Unleaded PVC	Grey	PVC	H07V-K	100 m
190708	450/750	25	50/0.250 mm	3.7 mm	70 °C	Unleaded PVC	Green	PVC	H07V-K	100 m
190910	50	24	50/0.250 mm	3.5 mm	70 °C	Unleaded PVC	Brown	PVC	Round	50 m
190972	50	24	50/0.250 mm	3.5 mm	70 °C	Unleaded PVC	White	PVC	Round	50 m

4 mm²

HC-CARGO	Voltage	Amp	Conductor dim.	OD	Temp. area	Insulator	Colour	Material	Type	Min supply
190677	50	32	48/ 0.310 mm	4.8 mm	70 °C	Unleaded PVC	Black	PVC	Round	50 m
190677Z	450/750	28	48/ 0.310 mm	4.3 mm	70 °C	Unleaded PVC	Black	PVC	H07V-K	50 m
190951	50	32	48/ 0.310 mm	4.8 mm	70 °C	Unleaded PVC	Red	PVC	Round	50 m

6 mm²

HC-CARGO	Voltage	Amp	Conductor dim.	OD	Temp. area	Insulator	Colour	Material	Type	Min supply
190678	50	41	72/0.310 mm	6.3 mm	70 °C	Unleaded PVC	Black	PVC	Round	50 m
191027	50	41	72/0.310 mm	6.3 mm	70 °C	Unleaded PVC	Red	PVC	Round	50 m
191175	450/750	36	72/0.380 mm	4.8 mm	70 °C	Unleaded PVC	Brown	PVC	H07V-K	100 m

THIN WALL

FLRY-B 0.35 mm²

HC-CARGO	Voltage	Amp	Conductor dim.	OD	Temp. area	Insulator	Colour	Material	Type	Min supply
193012	100	7	11-12/0.19 mm	1.6 mm	-40 - +100 °C	ISO 6722, Class B	Black	PVC	FLRY-B	100 m
193013	100	7	11-12/0.19 mm	1.6 mm	-40 - +100 °C	ISO 6722, Class B	Red	PVC	FLRY-B	100 m

FLRY-B 0.5 mm²

HC-CARGO	Voltage	Amp	Conductor dim.	OD	Temp. area	Insulator	Colour	Material	Type	Min supply
193049	60	11	16/0.21 mm	1.6 mm	-40 - +100 °C	Unleaded PVC	White	PVC	FLRY-B	100 m
193014	100	11	15-16/0.19 mm	1.6 mm	-40 - +100 °C	ISO 6722, Class B	Black	PVC	FLRY-B	100 m
193015	100	11	15-16/0.19 mm	1.6 mm	-40 - +100 °C	ISO 6722, Class B	Red	PVC	FLRY-B	100 m
193047	60	11	16/0.21 mm	1.6 mm	-40 - +100 °C	Unleaded PVC	Brown	PVC	FLRY-B	100 m
193048	60	11	16/0.21 mm	1.6 mm	-40 - +100 °C	Unleaded PVC	Green	PVC	FLRY-B	100 m
193050	60	11	16/0.21 mm	1.6 mm	-40 - +100 °C	Unleaded PVC	Grey	PVC	FLRY-B	100 m
193051	60	11	16/0.21 mm	1.6 mm	-40 - +100 °C	Unleaded PVC	Blue	PVC	FLRY-B	100 m
193052	60	11	16/0.21 mm	1.6 mm	-40 - +100 °C	Unleaded PVC	Yellow	PVC	FLRY-B	100 m

FLRY-B 0.75 mm²

HC-CARGO	Voltage	Amp	Conductor dim.	OD	Temp. area	Insulator	Colour	Material	Type	Min supply
193053	60	14	24/0.21 mm	1.9 mm	-40 - +100 °C	Unleaded PVC	Blue	PVC	FLRY-B	100 m
193054	60	14	24/0.21 mm	1.9 mm	-40 - +100 °C	Unleaded PVC	Brown	PVC	FLRY-B	100 m
193055	60	14	24/0.21 mm	1.9 mm	-40 - +100 °C	Unleaded PVC	Green	PVC	FLRY-B	100 m
193056	60	14	24/0.21 mm	1.9 mm	-40 - +100 °C	Unleaded PVC	Yellow	PVC	FLRY-B	100 m
193057	60	14	24/0.21 mm	1.9 mm	-40 - +100 °C	Unleaded PVC	White	PVC	FLRY-B	100 m
193058	60	14	24/0.21 mm	1.9 mm	-40 - +100 °C	Unleaded PVC	Red	PVC	FLRY-B	100 m
193059	60	14	24/0.21 mm	1.9 mm	-40 - +100 °C	Unleaded PVC	Black	PVC	FLRY-B	100 m
193060	60	14	24/0.21 mm	1.9 mm	-40 - +100 °C	Unleaded PVC	Grey	PVC	FLRY-B	100 m

FLRY-B 1 mm²

HC-CARGO	Voltage	Amp	Conductor dim.	OD	Temp. area	Insulator	Colour	Material	Type	Min supply
193061	60	16.5	32/0.210 mm	2.1 mm	-40 - +100 °C	Unleaded PVC	Blue	PVC	FLRY-B	100 m
193062	60	16.5	32/0.210 mm	2.1 mm	-40 - +100 °C	Unleaded PVC	Brown	PVC	FLRY-B	100 m
193063	60	16.5	32/0.210 mm	2.1 mm	-40 - +100 °C	Unleaded PVC	Green	PVC	FLRY-B	100 m
193064	60	16.5	32/0.210 mm	2.1 mm	-40 - +100 °C	Unleaded PVC	Yellow	PVC	FLRY-B	100 m
193065	60	16.5	32/0.210 mm	2.1 mm	-40 - +100 °C	Unleaded PVC	White	PVC	FLRY-B	100 m
193066	60	16.5	32/0.210 mm	2.1 mm	-40 - +100 °C	Unleaded PVC	Red	PVC	FLRY-B	100 m
193067	60	16.5	32/0.210 mm	2.1 mm	-40 - +100 °C	Unleaded PVC	Black	PVC	FLRY-B	100 m
193068	60	16.5	32/0.210 mm	2.1 mm	-40 - +100 °C	Unleaded PVC	Grey	PVC	FLRY-B	100 m

FLRY-B 1.5 mm²

HC-CARGO	Voltage	Amp	Conductor dim.	OD	Temp. area	Insulator	Colour	Material	Type	Min supply
193069	60	21	30/0.26 mm	2.4 mm	-40 - +100 °C	Unleaded PVC	Blue	PVC	FLRY-B	50 m
193070	60	21	30/0.26 mm	2.4 mm	-40 - +100 °C	Unleaded PVC	Brown	PVC	FLRY-B	50 m
193071	60	21	30/0.26 mm	2.4 mm	-40 - +100 °C	Unleaded PVC	Green	PVC	FLRY-B	50 m
193072	60	21	30/0.26 mm	2.4 mm	-40 - +100 °C	Unleaded PVC	Yellow	PVC	FLRY-B	50 m
193073	60	21	30/0.26 mm	2.4 mm	-40 - +100 °C	Unleaded PVC	White	PVC	FLRY-B	50 m
193074	60	21	30/0.26 mm	2.4 mm	-40 - +100 °C	Unleaded PVC	Red	PVC	FLRY-B	50 m
193075	60	21	30/0.26 mm	2.4 mm	-40 - +100 °C	Unleaded PVC	Grey	PVC	FLRY-B	50 m
193076	60	21	30/0.26 mm	2.4 mm	-40 - +100 °C	Unleaded PVC	Black	PVC	FLRY-B	50 m

FLRY-B 2 mm²

HC-CARGO	Voltage	Amp	Conductor dim.	OD	Temp. area	Insulator	Colour	Material	Type	Min supply
193077	60	25	28/0.31 mm	2.8 mm	-40 - +100 °C	Unleaded PVC	Blue	PVC	FLRY-B	50 m
193078	60	25	28/0.31 mm	2.8 mm	-40 - +100 °C	Unleaded PVC	Brown	PVC	FLRY-B	50 m
193079	60	25	28/0.31 mm	2.8 mm	-40 - +100 °C	Unleaded PVC	Green	PVC	FLRY-B	50 m
193080	60	25	28/0.31 mm	2.8 mm	-40 - +100 °C	Unleaded PVC	Yellow	PVC	FLRY-B	50 m
193081	60	25	28/0.31 mm	2.8 mm	-40 - +100 °C	Unleaded PVC	White	PVC	FLRY-B	50 m
193082	60	25	28/0.31 mm	2.8 mm	-40 - +100 °C	Unleaded PVC	Red	PVC	FLRY-B	50 m
193083	60	25	28/0.31 mm	2.8 mm	-40 - +100 °C	Unleaded PVC	Grey	PVC	FLRY-B	50 m
193084	60	25	28/0.31 mm	2.8 mm	-40 - +100 °C	Unleaded PVC	Black	PVC	FLRY-B	50 m

FLRY-B 4 mm²

HC-CARGO	Voltage	Amp	Conductor dim.	OD	Temp. area	Insulator	Colour	Material	Type	Min supply
193085	60	39	56/0.31 mm	3.7 mm	-40 - +100 °C	Unleaded PVC	Red	PVC	FLRY-B	50 m
193086	60	39	56/0.31 mm	3.7 mm	-40 - +100 °C	Unleaded PVC	Black	PVC	FLRY-B	50 m
193087	60	39	56/0.31 mm	3.7 mm	-40 - +100 °C	Unleaded PVC	Brown	PVC	FLRY-B	50 m

FLRY-B 6 mm ²										
HC-CARGO	Voltage	Amp	Conductor dim.	OD	Temp. area	Insulator	Colour	Material	Type	Min supply
193088	60	50	84/0.31 mm	4.3 mm	-40 - +100 °C	Unleaded PVC	Red	PVC	FLRY-B	50 m
193089	60	50	84/0.31 mm	4.3 mm	-40 - +100 °C	Unleaded PVC	Black	PVC	FLRY-B	50 m
193090	60	50	84/0.31 mm	4.3 mm	-40 - +100 °C	Unleaded PVC	Brown	PVC	FLRY-B	50 m
DOUBLE INSULATED										
1.5 mm ²										
HC-CARGO	Voltage	Amp	Conductor dim.	OD	Temp. area	Insulator	Colour	Material	Type	Min supply
190948	50	16	30/0.250 mm	4 mm	70 °C	Unleaded PVC	Black	PVC		100 m
190954	50	16	30/0.250 mm	4 mm	70 °C	Unleaded PVC	Black	PVC		100 m
2.5 mm ²										
HC-CARGO	Voltage	Amp	Conductor dim.	OD	Temp. area	Insulator	Colour	Material	Type	Min supply
191002	50	25	50/0.250 mm	4.2 mm	70 °C	Unleaded PVC	Black	PVC		100 m
SINGLE CORE SILICONE										
HC-CARGO	Voltage	Amp	Conductor dim.	OD	Temp. area	Insulator	Colour	Material	Type	Min supply
191923	50	16	392/0.07 mm	2.7 mm	-50 - +180 °C		Black			50 m
191924	50	16	392/0.07 mm	2.8 mm	-50 - +180 °C		Red			50 m
TRAILFLEX ADR										
<ul style="list-style-type: none"> • TÜV Approved for ADR Applications. • Specially developed and approved durable dual sheath construction. • Cores insulated to a minimum of ISO 6722. • Polyurethane sheathing ensures resistance to diesel oil, lerosene, dilute acids and alkalis. • Excellent short-term dielectric strength (upto 3KV). 										
No./core	Conductor dim.	Amp	Colour	HC-CARGO	Reel					
2×1 mm ²	27/0.210 mm	10	White/brown	192093	50 m					
2×1 mm ²	27/0.210 mm	10	White/brown	B192093	3000 m					
5×3x1.5+2x4 mm ²	19/0.31+48/0.31 mm	12/24	Red/brown/black/yellow/white	192096	50 m					
7×3x1.5+2x4+(2x1.5) mm ²	19/0.31+48/0.31 mm	10/24	Red/brown/blue/white/white-green/white- brown	192227	50 m					
7×6x1.5+1x2.5 mm ²	30/0.250+50/0.250 mm	10/16	White/black/yellow/red/green/brown/blue	192099	50 m					
LOUDSPEAKER										
No./core	Conductor dim.	Amp	Colour	HC-CARGO	Reel					
2×0.38 mm ²	12/0.200 mm	3	Blue/grey	190710	100 m					
2×0.38 mm ²	12/0.200 mm	3	Black/red	191777	100 m					
2×0.75 mm ²	24/0.195 mm	6	Black/red	190845	100 m					
2×0.75 mm ²	24/0.195 mm	6	Transparent	191087	100 m					
2×1.5 mm ²	30/0.250 mm	16	Black/red	191086	100 m					
2×2.5 mm ²	50/0.250 mm	20	Black/red	191093	100 m					
MULTI CORE SILICONE										
2X1.5 mm ²										
No./core	Conductor dim.	Amp	Colour	Voltage	HC-CARGO	Reel				
2×1.5 mm ²	30/0.250 mm	16	Blue/brown	500	191928	100 m				
2X0.75 mm ²										
No./core	Conductor dim.	Amp	Colour	Voltage	HC-CARGO	Reel				
2×0.75 mm ²	24/0.195 mm	6	Blue/brown	500	191927	100 m				
MULTI CORE WHITE COVER										
No./core	Conductor dim.	Amp	Colour	Voltage	HC-CARGO	Reel				
2×0.75 mm ²	24/0.195 mm	6	Blue/brown	450/750	190675	100 m				
2×0.75 mm ²	24/0.195 mm	6	Blue/brown	300/300	190685	100 m				
3G×1.5 mm ²	25/0.260 mm	16	Blue/brown/yellow-green	300/500	192820	50 m				
GREY COVER										
No./core	Conductor dim.	Amp	Colour	Voltage	HC-CARGO	Reel				
2×0.75 mm ²	24/0.200 mm	9	White/brown	50	191620	100 m				
4 × 0.75 mm ²	24/0.200 mm	9	White/brown/green/yellow	50	191621	100 m				
12 × 1 mm ²	32/0.210 mm	12		50	191623	100 m				

BLACK COVER

No./core	Conductor dim.	Amp	Colour	Voltage	HC-CARGO	Reel
2x0.75 mm ²	20/0.210 mm	6	Blue/brown	300/500	190690	100 m
2x0.75 mm ²	24/0.195 mm	6	Blue/brown	50	190676	50 m
2x0.75 mm ²	24/0.195 mm	6	Blue/brown	50	190686	50 m
2x1 mm ²	26/0.210 mm	10	Blue/brown	300/500	191617	100 m
2x 1 mm ²	26/0.210 mm	12	Blue/brown	450/750	190691	100 m
2x1 mm ²	32/0.195 mm	10	Blue/brown	50	191817	50 m
2x1 mm ²	32/0.195 mm	10	White/black	50	192789	50 m
2x1.5 mm ²	25/0.260 mm	16	Blue/brown	300/500	191618	100 m
2x1.5 mm ²	25/0.260 mm	16	Blue/brown	450/750	190693	100 m
2x1.5 mm ²	30/0.250 mm	16	Blue/brown	50	190688	50 m
2x1.5 mm ²	30/0.250 mm	16	Blue/brown	50	190709	50 m
2x2.5 mm ²	50/0.250 mm	20	Blue/brown	50	191160	50 m
2x2.5 mm ²	50/0.250 mm	20	Blue/brown	50	192951	50 m
3x0.75 mm ²	24/0.195 mm	6	Blue/brown/black	50	190687	50 m
3x1 mm ²	32/0.195 mm	10	Blue/brown/black	50	190689	50 m
3x1.5 mm ²	25/0.260 mm	16	Blue/brown/yellow-green	300/500	192555	50 m
3x1.5 mm ²	25/0.260 mm	16	Blue/brown/yellow-green	450/750	191131	100 m
3x1.5 mm ²	30/0.250 mm	16	Blue/brown/black	50	191130	50 m
4x0.75 mm ²	24/0.195 mm	6	Blue/brown/black/yellow	50	191135	50 m
4x1 mm ²	32/0.195 mm	10	Blue/brown/black/yellow	50	190950	50 m
4x1.5 mm ²	25/0.260 mm	16	Blue/brown/black/yellow-green	300/500	191619	50 m
4x1.5 mm ²	25/0.260 mm	16	Blue/brown/black/yellow-green	450/750	191062	100 m
4x1.5 mm ²	30/0.250 mm	16	Blue/brown/black/yellow	50	191136	50 m
5x0.75 mm ²	24/0.195 mm	4.5	Blue/brown/black/yellow/green	50	191419	50 m
5x1 mm ²	32/0.195 mm	7.5	Blue/brown/black/yellow/green	50	190981	50 m
5x1.5 mm ²	30/0.250 mm	12	Blue/brown/black/yellow/green	50	190666	50 m
5x2.5 mm ²	25/0.260 mm	20	Blue/brown/black/black/yellow-green	450/750	192103	50 m
6x0.75 mm ²	24/0.195 mm	4.5	Blue/brown/black/yellow/white/red	50	191418	50 m
7x0.75 mm ²	24/0.195 mm	3.9	Blue/brown/black/yellow/green	50	190979	50 m
7x1 mm ²	32/0.195 mm	6.5	Blue/brown/black/yellow/green	50	190993	50 m
7x1.5 mm ²	30/0.250 mm	16	Blue/brown/black/yellow/green	50	190667	50 m
7x6x1+1x2.5 mm ²	32/0.195+50/0.250 mm	7.5/18.7	Blue/brown/black/yellow/green	50	190711	50 m
7x6x1.5+1x2.5 mm ²	30/0.250+50/0.250 mm	10/16	Blue/brown/black/yellow/green	50	191043	50 m
12x1.5 mm ²	30/0.250 mm	8.8	Blue/brown/black/yellow/green/red/white/grey/violet/pink/orange/turquoise	50	191058	50 m
13x10x1.5+3x2.5 mm ²	30/0.250+50/0.250 mm	8/12.5/7	Blue/brown/black/yellow/green/red/white/grey/violet/pink/orange/turquoise/tansparent	50	191095	50 m
13x9x1.5+4x2.5 mm ²	30/0.250+50/0.250 mm	8/12.5	Blue/brown/black/yellow/green/red/white/grey/purple/pink/orange/turquoise, Pink/orange/lightblue/beige	50	192104	50 m
15x10x1.5+3x2.5+1x(2x1.5) mm ²	30/0.250+50/0.250 mm	8/12.5	White/orange/white-red/yellow/lightgreen/blue, Black/red/pink/grey/white-black/white-lightgreen/white-blue/white-brown/brown	50	192102	50 m

WELDING

RED PVC COVER

No./core	Conductor dim.	Amp	HC-CARGO	Reel
1x10 mm ²	304/0.2 mm	106	191535	25 m
1x16 mm ²	462/0.2 mm	135	191574	25 m
1x16 mm ²	462/0.2 mm	135	B191574	100 m
1x25 mm ²	742/0.2 mm	170	191451	25 m
1x25 mm ²	742/0.2 mm	170	B191451	100 m
1x35 mm ²	1008/0.2 mm	217	191452	25 m
1x35 mm ²	1008/0.2 mm	217	B191452	100 m
1x50 mm ²	1482/0.2 mm	280	191453	25 m
1x50 mm ²	1482/0.2 mm	280	B191453	50 m
1x70 mm ²	2090/0.2 mm	350	192446	10 m
1x70 mm ²	2090/0.2 mm	350	B192446	50 m

ORANGE PVC/NBR COVER				
No./core	Conductor dim.	Amp	HC-CARGO	Reel
1×25 mm ²	742/0.2 mm	195	191522	25 m
1×35 mm ²	1050/0.2 mm	245	191523	25 m
1×35 mm ²	1050/0.2 mm	245	B191523	100 m
1×50 mm ²	1482/0.2 mm	310	191524	25 m
1×70 mm ²	2090/0.2 mm	385	192445	10 m
BLACK PVC COVER				
No./core	Conductor dim.	Amp	HC-CARGO	Reel
1×10 mm ²	312/0.2 mm	106	191445	25 m
1×16 mm ²	462/0.2 mm	124	191446	25 m
1×16 mm ²	462/0.2 mm	135	B191446	100 m
1×25 mm ²	742/0.2 mm	170	191447	25 m
1×25 mm ²	742/0.2 mm	170	B191447	100 m
1×35 mm ²	1008/0.2 mm	217	191448	25 m
1×35 mm ²	1008/0.2 mm	217	B191448	100 m
1×50 mm ²	1482/0.2 mm	280	191449	25 m
1×50 mm ²	1482/0.2 mm	280	B191449	50 m
1×70 mm ²	2090/0.2 mm	346	191450	10 m
1×70 mm ²	2090/0.2 mm	346	B191450	50 m
1×95 mm ²	2812/0.20 mm	387	192881	10 m
1×95 mm ²	2812/0.20 mm	387	B192881	50 m
BLACK PVC/NBR COVER				
No./core	Conductor dim.	Amp	HC-CARGO	Reel
1×10 mm ²	304/0.2 mm	115	191516	25 m
1×16 mm ²	490/0.2 mm	145	191517	25 m
1×25 mm ²	742/0.2 mm	195	191518	25 m
1×35 mm ²	1050/0.2 mm	245	191519	25 m
1×50 mm ²	1482/0.2 mm	310	191520	25 m
1×70 mm ²	2090/0.2 mm	385	191521	10 m
95 mm ²	2812/0.20 mm	430	192882	10 m
STARTER				
RED PVC COVER				
No./core	Conductor dim.	Amp	HC-CARGO	Reel
1×35 mm ²	420/0.31 mm	135	192291	25 m
1×35 mm ²	420/0.31 mm	135	B192291	100 m
1×50 mm ²	588/0.31 mm	160	192292	25 m
1×50 mm ²	588/0.31 mm	160	B192292	50 m
BLACK PVC COVER				
No./core	Conductor dim.	Amp	HC-CARGO	Reel
1×10 mm ²	120/0.31 mm	63	191132	25 m
1×10 mm ²	120/0.31 mm	63	B191132	100 m
1×16 mm ²	196/0.31 mm	82	190680	25 m
1×16 mm ²	196/0.31 mm	82	B190680	100 m
1×25 mm ²	294/0.31 mm	110	190681	25 m
1×25 mm ²	294/0.31 mm	110	B190681	100 m
1×35 mm ²	420/0.31 mm	135	190682	25 m
1×35 mm ²	420/0.31 mm	135	B190682	100 m
1×50 mm ²	588/0.31 mm	160	190683	25 m
1×50 mm ²	588/0.31 mm	160	B190683	50 m
1×70 mm ²	840/0.31 mm	205	190684	10 m
1×70 mm ²	840/0.31 mm	205	B190684	50 m

PARALLEL TWIN BATTERY

No./core	Conductor dim.	Amp	HC-CARGO	Reel
2×10 mm ²	296/0.2 mm	63	191795	25 m
2×16 mm ²	462/0.2 mm	135	191796	25 m
2×25 mm ²	722/0.21 mm	230	191525	10 m
2×25 mm ²	722/0.21 mm	230	B191525	100 m
2×35 mm ²	1026/0.2 mm	290	191526	10 m
2×4 mm ²	114/0.2 mm	28	191793	25 m
2×6 mm ²	172/0.2 mm	36	191794	25 m
2×35 mm ²	1026/0.2 mm	290	B191526	50 m
2×50 mm ²	1482/0.2 mm	370	191527	10 m

DISPLAY

06219 Cable/Shrink Pipe Display

Contains maks. 8 boxes. Can be placed on the counter or mounted on wall.



BOOSTER

STEEL CLIPS

192206 Booster cable set



Amp: 80

Conductor dim.:
79/0.4 mm
Conductor dim. 2:
10 mm²
Length: 2.5 m

Colour: Red/black
Material: Galvanised steel
No./wires: 2

192207 Booster cable set



Amp: 100

Conductor dim.:
126/0.4 mm
Conductor dim. 2:
16 mm²
Length: 2.5 m

Colour: Red/black
Material: Galvanised steel
No./wires: 2

192208 Booster cable set



Amp: 120

Conductor dim.:
188/0.4 mm
Conductor dim. 2:
25 mm²
Length: 2.5 m

Colour: Red/black
Material: Galvanised steel
No./wires: 2

BRASS CHARGING CLIPS







192209 Booster cables



Amp: 230

Conductor dim.:
770/0.2 mm
Conductor dim. 2:
25 mm²
Length: 3.5 m

Colour: Red/black
Material: Moulded brass
No./wires: 2
BS-approved: BS638

	EL. SPECIFICATIONS	DIMENSIONS	ADDITIONAL SPECIFICATIONS
192210 Booster cable set 	Amp: 290	Conductor dim.: 1083/0.2 mm Conductor dim. 2: 35 mm ² Length: 3.5 m	Colour: Red/black Material: Moulded brass No./wires: 2 BS-approved: BS638
192211 Booster cable set 	Amp: 370	Conductor dim.: 1558/0.2 mm Conductor dim. 2: 50 mm ² Length: 3.5 m	Colour: Red/black Material: Moulded brass No./wires: 2 BS-approved: BS638
192212 Booster cable set 	Amp: 370	Conductor dim.: 1558/0.2 mm Conductor dim. 2: 50 mm ² Length: 5 m	Colour: Red/black Material: Moulded brass No./wires: 2 BS-approved: BS638
192295 Booster cables set 	Amp: 135	Conductor dim.: 265/0.41 mm Conductor dim. 2: 35 mm ² Length: 3.5 m	Colour: Red/black Material: Moulded brass No./wires: 2
192296 Booster cables set 	Amp: 160	Conductor dim.: 378/0.41 mm Conductor dim. 2: 50 mm ² Length: 5 m	Colour: Red/black Material: Moulded brass No./wires: 2
192844 Booster Cable 	Amp: 290	Conductor dim.: 1008/0.2 mm Conductor dim. 2: 35 mm ² Length: 5 m	Colour: Red/black Material: Moulded brass No./wires: 2 BS-approved: BS638
FULLY INSULATED CLIPS			
192213 Booster cable set 	Amp: 290	Conductor dim.: 1083/0.2 mm Conductor dim. 2: 35 mm ² Length: 3.5 m	Colour: Red/black No./wires: 2 Insulator: Yes Braided link: w/ BS-approved: BS638

EL. SPECIFICATIONS
DIMENSIONS
ADDITIONAL SPECIFICATIONS
192214 Booster cable set

Amp: 370

Conductor dim.:
1558/0.2 mm
Conductor dim. 2:
50 mm²
Length: 3.5 m

Colour: Red/black
Material: Compressed steel
No./wires: 2
Insulator: Yes
Braided link: w/
BS-approved: BS638

192215 Booster cable set

Amp: 370

Conductor dim.:
1558/0.2 mm
Conductor dim. 2:
50 mm²
Length: 5 m

Colour: Red/black
Material: Compressed steel
No./wires: 2
Insulator: Yes
Braided link: w/
BS-approved: BS638

192384 Booster cable

Amp: 290

Conductor dim.:
1083/0.2 mm
Conductor dim. 2:
35 mm²
Length: 3.5 m

Colour: Red/black
Material: Copper/Brass
No./wires: 2
Insulator: Yes
Braided link: w/
DIN no.: 72553

192385 Booster cable

Amp: 370

Conductor dim.:
1558/0.2 mm
Conductor dim. 2:
50 mm²
Length: 5 m

Colour: Red/black
Material: Copper/Brass
No./wires: 2
Insulator: Yes
Braided link: w/
DIN no.: 72553

COILS
BATTERY

	Lead dim.	Windings	Material	Colour	OD	Working length	HC-CARGO
	25 mm ²	35	Polyurethan	Black	13.5 mm	3.5 m	191201
	25 mm ²	35	Polyurethan	Red	13.5 mm	3.5 m	191238
	2x35 mm ²	35	Polyurethan	Red/black	13.5 mm	3.5 m	192722
	35 mm ²	35	Polyurethan	Black	13.5 mm	3.5 m	192723
	35 mm ²	35	Polyurethan	Red	13.5 mm	3.5 m	192724

ELECTRICAL

	Lead dim.	Windings	Material	DIN Norm	ISO Norm	Plug type	Working length	HC-CARGO	
	2x6/3x1.5 mm ²	48	Polyurethan	74001	4141	5-core	4 m	191179	
	4x0.75 mm ²	68	Polyurethan	72575		4-core	5.5 m	192582	<i>Tail length: 20/200 cm.</i>
	5x0.75 mm ²	68	Polyurethan		7638	5-core	5.5 m	192583	<i>Tail length: 20/200 cm.</i>
	6x1+1x2 mm ²	20	Nylon	72551	4141	7-core	3.5 m	191013	
	6x1+1x2 mm ²	42	Polyurethan		4141	7-core	3.5 m	191088	<i>Length at rest 0.47 m.</i>
	6x1+1x2 mm ²	63	Polyurethan			7-core	5 m	191495	
	12x1.5+3x2.5 mm ²	34	Polyurethan		12098	15-core	3.5 m	191195	

MARKERS

	HC-CARGO	No.	Cable size	OD	Cable type	Material
	192836	2	0.75-2.5 mm ²	3.6 mm	Clip-on	Plastic
	192837	3	0.75-2.5 mm ²	3.6 mm	Clip-on	Plastic
	192838	4	0.75-2.5 mm ²	3.6 mm	Clip-on	Plastic
	192840	6	0.75-2.5 mm ²	3.6 mm	Clip-on	Plastic

IGNITION

150401 Protection Cap

For spark plug cap. Angled.

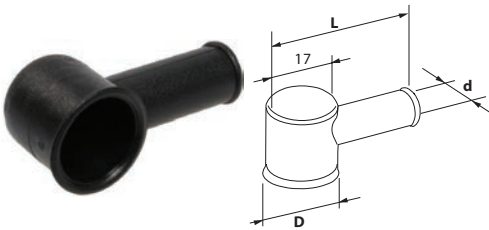

Cable dia.: 7.5 mm
Cable dia. 2: 15
Length: 41 mm

Colour: Black
Material: PVC

190695 Ignition Cable



Conductor dim.:
19/0.3 mm
Conductor dim. 2:
1.5 mm²
OD: 7 mm
Rolls size: 50 m

Type: Ignition cable
Cap colour: Black
Cap material: PVC

CABLE EYELETS

191805 Cable Eyelet



ID: 4.3 mm
OD: 7.2 mm
Height: 3.6 mm

Material: Brass

192658 Cable Eyelet



ID: 5 mm
OD: 8 mm
Height: 3.6 mm

Material: Brass

HOSES & PIPES

HOSES

WOVEN

	HC-CARGO	ID	Length	Box dim.	Pressure	DIN Norm	
	191499	3.2 mm	20 m	28.5x29.5x11.5	5 bar		Also for unleaded petrol.
	190994	3.5 mm	10 m	28.5x29.5x11.5	5 bar		Also for unleaded petrol.
	191014	4.5 mm	20 m	28.5x29.5x11.5	5 bar		Also for unleaded petrol.
	190995	5 mm	20 m	28.5x29.5x11.5	5 bar		Also for unleaded petrol.
	190996	6 mm	20 m	28.5x29.5x11.5	5 bar		Also for unleaded petrol.
	190997	7.5 mm	20 m	28.5x29.5x11.5	5 bar		Also for unleaded petrol.
	191015	9 mm	20 m	28.5x29.5x11.5	5 bar		Also for unleaded petrol.
	090380	10 mm	1 m	28.5x29.5x11.5			Bio diesel.
	192361	11 mm	10 m	28.5x29.5x11.5	5 bar		Also for unleaded petrol.

NON-WOVEN

	HC-CARGO	ID	Length	Box dim.	Pressure	DIN Norm	
	191182	3.5 mm	20 m	28.5x29.5x11.5	10 bar	73379	Also for unleaded petrol.
	190998	5 mm	20 m	28.5x29.5x11.5	10 bar	73379	Also for unleaded petrol.
	191063	5.5 mm	20 m	28.5x29.5x11.5x11.5	10 bar	73379	Also for unleaded petrol.
	190999	6 mm	20 m	28.5x29.5x11.5x11.5	10 bar	73379	Also for unleaded petrol.
	191000	7.5 mm	20 m	28.5x29.5x11.5	10 bar	73379	Also for unleaded petrol.
	190984	9.5 mm	20 m	28.5x29.5x11.5	10 bar	73379	Also for unleaded petrol.

PLASTIC

	HC-CARGO	ID	OD	Length	Pressure	Temp.	House Type
	090170	6 mm	10 mm	10 m	2.8 - 3.5 bar	-15°C - +60°C	Fuel
	090171	8 mm	12 mm	10 m	2.8 - 3.5 bar	-15°C - +60°C	Fuel
	190093	3 mm	4.5 mm	10 m		-15°C - +60°C	Washer
	190094	4 mm	5.5 mm	50 m		-15°C - +60°C	Washer
	190095	5 mm	7.3 mm	50 m		-15°C - +60°C	Washer
	190096	6 mm	9.8 mm	50 m		-15°C - +60°C	Washer
	190097	8 mm	11.6 mm	50 m		-15°C - +60°C	Washer

ARMOURED PLASTIC

190100 Armoured PA hose

Petrol and fuel resistant.



ID: 6 mm
Length: 50 m

Working pressure at °C: 25 kg./cm²

190101 Armoured hose

Petrol and fuel resistant.

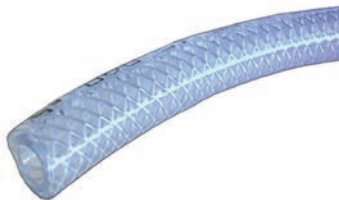

ID: 8 mm
Length: 50 m

Working pressure at °C: 20 kg./cm²

OVERFLOW

090293 Over flow hose high temperatur

Servicing: Among others Mercedes - Visit www.hc-cargo.com for further information

Specially designed for Mercedes where the nozzle is stored in the valve cover. Tolerates higher temperatures.



ID: 3 mm
Length: 20 m
Temp.: 110 °C
Pressure: 5 bar

Colour: Grey/red
Woven: Yes
Working pressure at °C: 5 kg./cm²

HEATER

192720 Heater Hose

Black EPDM rubber. Temperature resistant between -25°C-+100°C.



Box dim.:
28.5x29.5x11.5 cm
ID: 16 mm
Length: 10 m
Temp.: -25°C - +100°C
Pressure: 10 bar

Colour: Black

SYNTHETIC RUBBER STEEL WIRE

	HC-CARGO	ID	OD	Length	Pressure	Working pressure at 20 °C	Temp.	DIN Norm	
	090078	4.5 mm	9.5 mm	10 m	20 bar	20 kg./cm ²	-35°C - +80°C	73379	Braiding of galvanized steel wire.
	090079	5.5 mm	10.5 mm	10 m	20 bar	20 kg./cm ²	-35°C - +80°C	73379	Braiding of galvanized steel wire.
	090080	7.5 mm	12.5 mm	10 m	15 bar	15 kg./cm ²	-35°C - +80°C	73379	Braiding of galvanized steel wire.
	090081	9 mm	14 mm	10 m	15 bar	15 kg/cm ²	-35°C - +80°C	73379	Braiding of galvanized steel wire.
	090082	11 mm	17.7 mm	10 m	15 bar	15 kg/cm ²	-35°C - +80°C	73379	Braiding of galvanized steel wire.
	B090078	4.5 mm	9.5 mm	50 m	20 bar	20 kg/cm ²	-35°C - +80°C	73379	Braiding of galvanized steel wire.
	B090079	5.5 mm	10.5 mm	50 m	15 bar	15 kg/cm ²	-35°C - +80°C	73379	Braiding of galvanized steel wire.
	B090080	7.5 mm	12.5 mm	50 m	15 bar	15 kg/cm ²	-35°C - +80°C	73379	Braiding of galvanized steel wire.
	B090081	9 mm	14 mm	50 m	15 bar	15 kg/cm ²	-35°C - +80°C	73379	Braiding of galvanized steel wire.

POLYAMID PIPES

	HC-CARGO	ID	OD	Length	Pressure	Working pressure at 20 °C	Temp.	DIN Norm
	B090083	6 mm	8 mm	25 m	27 bar	20 kg./cm ²	-40°C - +100°C	74324
	B090084	8 mm	10 mm	25 m	27 bar	20 kg./cm ²	-40°C - +100°C	74324
	B090119	9 mm	12 mm	25 m	19 bar	20 kg./cm ²	-40°C - +100°C	74324
	B090148	4 mm	6 mm	25 m	27 bar	20 kg./cm ²	-40°C - +100°C	74324

VACUUM

191192 Vacuum Hose

	Box dim.: 28.5x29.5x11.5 cm ID: 3 mm Length: 20 m	Colour: Black
---	---	---------------

191193 Vacuum Hose

	Box dim.: 28.5x29.5x11.5 cm ID: 4 mm Length: 20 m	Hose type: Armoured Colour: Black
---	---	--------------------------------------

PIPES

HOSE SLEEVES

	HC-CARGO	ID	Length	OD
	080851	3 mm	12 mm	4 mm
	080285	5 mm	14.1 mm	6 mm
	080286	7 mm	15 mm	8 mm
	080621	8 mm	16 mm	9 mm
	080259	11 mm	17 mm	13 mm
	080260	11 mm	17 mm	11.5 mm
	080261	12 mm	20 mm	12.5 mm
	080262	13.5 mm	20 mm	13.5 mm
	080263	14 mm	20 mm	14.5 mm
	080264	16 mm	20 mm	16 mm
	080265	17 mm	21 mm	17.5 mm
	080267	17 mm	32 mm	23 mm
	080266	20 mm	26 mm	20 mm

NUTS
080297 Pipe Nut

 Thread: M10-1.5
 Spanner size: 14 mm

080667 Pipe Nut

 Thread: M10-1
 Spanner size: 12 mm

080668 Pipe Nut

 Thread: M 14-1.5
 Spanner size: 17 mm

080669 Pipe Nut

 Thread: M16-1.5
 Spanner size: 19 mm

080834 Pipe Nut

 ID: 6 mm
 Thread size: M12x1.5

CONNECTIONS

	HC-CARGO	Hose ID	Thread
	080829	6 mm	M10-1
	080830	6 mm	M12-1.5
	080831	8 mm	M14-1.5
	080930	8 mm	1/2"-20 UNF
	080931	8 mm	1/2"-20 UNF
	080268	8 mm	

STRAIGHT CONNECTIONS

	HC-CARGO	Pipe	Length	Thread
	080287	6 mm	M12-1.5	39 mm
	080288	8 mm	M14-1.5	40 mm
	080289	10 mm	M16-1.5	42 mm

CLAMPS

HOSE

	HC-CARGO	ID min	ID max	Width	Spanner size	Ref. no.	Coating	Material
	190157	8 mm	14 mm	9 mm	7 mm	15	El. galvanized, Alu/zinc, Lacquered	Steel
	193027	8 mm	14 mm	10 mm	7 mm	15	El. galvanized, Alu/zinc, Lacquered	Carbon steel
	190158	11 mm	17 mm	9 mm	7 mm	17	El. galvanized, Alu/zinc, Lacquered	Steel
	193028	11 mm	17 mm	10 mm	7 mm	17	El. galvanized, Alu/zinc, Lacquered	Carbon steel
	190159	13 mm	20 mm	9 mm	7 mm	22	El. galvanized, Alu/zinc, Lacquered	Steel
	193029	13 mm	20 mm	10 mm	7 mm	22	El. galvanized, Alu/zinc, Lacquered	Carbon steel
	190160	15 mm	24 mm	12 mm	7 mm	25	El. galvanized, Alu/zinc, Lacquered	Steel
	193030	15 mm	24 mm	12 mm	7 mm	25	El. galvanized, Alu/zinc, Lacquered	Carbon steel
	190161	19 mm	28 mm	12 mm	7 mm	28	El. galvanized, Alu/zinc, Lacquered	Steel
	193031	19 mm	28 mm	12 mm	7 mm	28	El. galvanized, Alu/zinc, Lacquered	Carbon steel
	190162	22 mm	32 mm	12 mm	7 mm	32	El. galvanized, Alu/zinc, Lacquered	Steel
	193032	22 mm	32 mm	12 mm	7 mm	32	El. galvanized, Alu/zinc, Lacquered	Carbon steel
	190163	26 mm	38 mm	12 mm	7 mm	40	El. galvanized, Alu/zinc, Lacquered	Steel
	193033	26 mm	38 mm	12 mm	7 mm	40	El. galvanized, Alu/zinc, Lacquered	Carbon steel
	190164	32 mm	44 mm	12 mm	7 mm	45	El. galvanized, Alu/zinc, Lacquered	Steel
	193034	32 mm	44 mm	12 mm	7 mm	45	El. galvanized, Alu/zinc, Lacquered	Carbon steel
	190165	38 mm	50 mm	12 mm	7 mm	51	El. galvanized, Alu/zinc, Lacquered	Steel
	193035	38 mm	50 mm	12 mm	7 mm	51	El. galvanized, Alu/zinc, Lacquered	Carbon steel
	190166	44 mm	56 mm	12 mm	7 mm	56	El. galvanized, Alu/zinc, Lacquered	Steel
	193036	44 mm	56 mm	12 mm	7 mm	56	El. galvanized, Alu/zinc, Lacquered	Carbon steel
190167	50 mm	65 mm	12 mm	7 mm	65	El. galvanized, Alu/zinc, Lacquered	Steel	
193037	50 mm	65 mm	12 mm	7 mm	65	El. galvanized, Alu/zinc, Lacquered	Carbon steel	
190168	58 mm	75 mm	12 mm	7 mm	75	El. galvanized, Alu/zinc, Lacquered	Steel	
193038	58 mm	75 mm	12 mm	7 mm	75	El. galvanized, Alu/zinc, Lacquered	Carbon steel	
190169	68 mm	85 mm	12 mm	7 mm	85	El. galvanized, Alu/zinc, Lacquered	Steel	
193039	68 mm	85 mm	12 mm	7 mm	85	El. galvanized, Alu/zinc, Lacquered	Carbon steel	
190170	77 mm	95 mm	12 mm	7 mm	96	El. galvanized, Alu/zinc, Lacquered	Steel	
193040	77 mm	95 mm	12 mm	7 mm	96	El. galvanized, Alu/zinc, Lacquered	Carbon steel	
190171	87 mm	112 mm	12 mm	7 mm	113	El. galvanized, Alu/zinc, Lacquered	Steel	
193041	87 mm	112 mm	12 mm	7 mm	113	El. galvanized, Alu/zinc, Lacquered	Carbon steel	
190172	104 mm	138 mm	12 mm	7 mm	139	El. galvanized, Alu/zinc, Lacquered	Steel	
191239	130 mm	165 mm	12 mm	7 mm	166	El. galvanized, Alu/zinc, Lacquered	Steel	

MINI

	HC-CARGO	ID min	ID max	Width	Spanner size	Ref. no.	Coating	Material
	190005	6 mm	8.3 mm	9 mm	7 mm	8	El. galvanized, Alu/zinc, Lacquered	Steel
	190006	7 mm	9.3 mm	9 mm	7 mm	9	El. galvanized, Alu/zinc, Lacquered	Steel
	190007	8 mm	10.3 mm	9 mm	7 mm	10	El. galvanized, Alu/zinc, Lacquered	Steel
	190008	9 mm	11.3 mm	9 mm	7 mm	10	El. galvanized, Alu/zinc, Lacquered	Steel
	190009	9 mm	12.3 mm	9 mm	7 mm	12	El. galvanized, Alu/zinc, Lacquered	Steel
	190010	10 mm	13.3 mm	9 mm	7 mm	13	El. galvanized, Alu/zinc, Lacquered	Steel
	190937	11 mm	14.3 mm	9 mm	7 mm	14	El. galvanized, Alu/zinc, Lacquered	Steel
	190938	12 mm	15.3 mm	9 mm	7 mm	15	El. galvanized, Alu/zinc, Lacquered	Steel
	191056	13 mm	16.3 mm	9 mm	7 mm	16	El. galvanized, Alu/zinc, Lacquered	Steel
	192054	14 mm	17.3 mm	9 mm	7 mm	17	El. galvanized, Alu/zinc, Lacquered	Steel

PIPE

	HC-CARGO	ID	Material
	191592	42 mm	Galvanised steel
	191593	45 mm	Galvanised steel
	191594	48 mm	Galvanised steel
	191595	51 mm	Galvanised steel
	191596	54 mm	Galvanised steel
	191597	57 mm	Galvanised steel

EAR CLIPS

192817 Ear Clip

w/ inserts. Min. 8.5 mm. Max 10.5 mm.



192818 Ear Clip

w/ inserts. Min. 9.5 mm. Max 11.5 mm.



TAPES

INSULATION TAPE



	HC-CARGO	Width	Colour	Dim.	Material
	190180	15 mm	Black	0.1 mm × 10 m	PVC
	190181	15 mm	Red	0.1 mm × 10 m	PVC
	190182	15 mm	Blue	0.1 mm × 10 m	PVC
	190183	15 mm	Green	0.1 mm × 10 m	PVC
	190184	15 mm	Yellow	0.1 mm × 10 m	PVC
	190185	15 mm	Grey	0.1 mm × 10 m	PVC
	190186	15 mm	White	0.1 mm × 10 m	PVC
	190187	19 mm	Black	0.1 mm × 10 m	PVC
	191065	50 mm	Black	0.2 mm × 20 m	PVC
	192819	15 mm	Brown	0.1 mm × 10 m	PVC
	193220	15 mm	Black	0.1 mm × 10 m	PVC
	193221	15 mm	Red	0.1 mm × 10 m	PVC
	193222	15 mm	Blue	0.1 mm × 10 m	PVC
	193223	15 mm	Green	0.1 mm × 10 m	PVC
	193224	15 mm	Yellow	0.1 mm × 10 m	PVC
	193225	15 mm	Grey	0.1 mm × 10 m	PVC
	193226	15 mm	White	0.1 mm × 10 m	PVC
193227	19 mm	Black	0.1 mm × 10 m	PVC	
193228	50 mm	Black	0.2 mm × 20 m	PVC	

TEXTILE TAPE

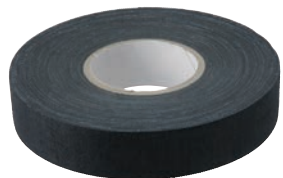

	HC-CARGO	Width	Colour	Length	Material
	191237	19 mm	Black	25 m	Textile
	192366	9 mm	Black	25 m	Textile
	192755	50 mm	Grey	50 m	Textile
	193230	19 mm	Black	25 m	Textile
	193231	9 mm	Black	25 m	Textile
	193232	50 mm	Grey	50 m	Textile

FIELD COIL TAPE



	HC-CARGO	Width	Length	Material
	191377	10 mm	100 m	Cotton
	191378	20 mm	100 m	Cotton

THREAD SEAL TAPE

192379 Threaded Tape



Length: 12 m
Thickness: 12 mm

Colour: White
Material: PTFE

MASKING

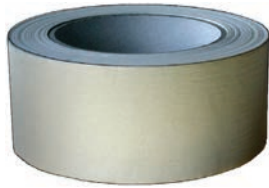

HC-CARGO

200005
200004

Width

25 mm
50 mm

Length

50 m
50 m

DOUBLE ADHESIVE

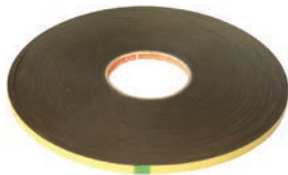

HC-CARGO

200641
200642

Width

9 mm
19 mm

Colour

Black
Black

Dim.

0.8 mm × 50 m
0.8 mm × 66 m

Material

PE
PE

ADHESIVE

ENGINEERING

200027 Engineering Adhesive

Typical applications. Resistant to vibration and leakage of threaded coating. A single component anaerobic adhesive that is tiksotropic. Cures in the absence of air between close fitting metal surfaces.



Temp.: 22 °C
Content: 10 ml

Type: 270
Adhesive type: Tiksotropic
Hardening time: 6 hours
Strength: High

200654 Engineering Adhesive

Used to bond cylindrical fitting parts, particularly where disassembly may be required.



Temp.: 22 °C
Content: 50 ml

Type: 641
Adhesive type: Tiksotropic
Hardening time: 12 hours

200726 Engineering Adhesive

Typical application. Resists vibrations and leakage of threaded fasteners. Is a one component, anaerobic adhesive, which is thixotropic. It cures when confined in the absence of air between close fitting metal surfaces.



Temp.: 22 °C
Content: 10 ml

Type: 243
Adhesive type: Tiksotropic
Hardening time: 3 hours
Strength: Medium

200760 Engineering Adhesive

Typical applications. Resistant to vibration and leakage of threaded coating. A single component anaerobic adhesive that is tiksotropic. Cures in the absence of air between close fitting metal surfaces.



Temp.: 22 °C
Content: 50 ml

Type: 243
Adhesive type: Tiksotropic
Hardening time: 3 hours
Strength: Medium

200780 Engineering Adhesive

Typical applications. Resistant to vibration and leakage of threaded coating. A single component anaerobic adhesive that is tiksotropic. Cures in the absence of air between close fitting metal surfaces.



Temp.: 22 °C
Content: 50 ml

Type: 270
Adhesive type: Tiksotropic
Hardening time: 6 hours
Strength: High

QUICK EPOXY
200652 Epoxy Adhesive

For general use. Effective on metal, ceramic, wood etc. Can be used at low temperature and be painted over.



Temp.: 22 °C
Content: 24 ml

Type: 3430
Adhesive type: Quick epoxy adhesive
Hardening time: 5-20 min

CYANOACRYLATE
200028 Cyanoacrylate Adhesive

LOCTITE 401 is an ethyl cyanoacrylate adhesive w/ exceptional curing performance on wood, paper and other absorbent surfaces. TYPICAL APPLICATIONS. Rapid bonding of leather, board, fabric or other absorbent surfaces.



Temp.: 22 °C
Content: 3 g

Type: 401
Adhesive type: Cyanoacrylate adhesive
Hardening time: 5-20 sec

200649 Cyanoacrylate Adhesive

LOCTITE 401 is an ethyl cyanoacrylate adhesive w/ exceptional curing performance on wood, paper and other absorbent surfaces. TYPICAL APPLICATIONS. Rapid bonding of leather, board, fabric or other absorbent surfaces.



Temp.: 22 °C
Content: 20 g

Type: 401
Adhesive type: Cyanoacrylate adhesive
Hardening time: 5-20 sec

200697 Cyanoacrylate Adhesive

LOCTITE 480 is a medium viscosity, fast curing, single component cyanoacrylate adhesive. It is specially formulated for increased flexibility and peel strength. TYPICAL APPLICATIONS: Rapid bonding of a wide range of metal, plastic and electrometric materials.



Temp.: 22 °C
Content: 20 g

Type: 480
Adhesive type: Cyanoacrylate adhesive
Hardening time: 60-120 sec.

SILICONE COMPOUND

134686 Dielectric Gel

Prevents fusing of spark wires and corrosion. Odourless, non-volatile. Works in extreme temperatures. Resists moisture, air, acids and alkalines.



Content: 142 g

200094 Silicone Compound

Used for motors, windshield and sunroof.



Content: 85 g

200789 Silicone Compound

Used for motors, windshield and sunroof.



Content: 227 g

SURFACE CLEANING

200300 Glass beads 300-400 micron

Used for sand blowing. Used for surface treatment eg. cleaning, fine trimming, deburring and tumbling.



Grades: 300-400
Grades 2: 0.3-0.4

Material: Glass

200400 Steel Shot

Used for sand blowing. Used for surface treatment eg. cleaning, fine trimming, deburring and tumbling.



Grades: 300-500
Grades 2: 0.3-0.5

Material: Steel
Approval: SAEJ444

200500 Steel Shot

Used for sand blowing. Used for surface treatment eg. cleaning, fine trimming, deburring and tumbling.



Grades: 212-600
Grades 2: 0.2-0.6

Material: Steel

ABRASIVE CLOTHS

	HC-CARGO	Grades	Dim.	Type	
	200721	P40	40 mm × 50 m	Rolls	A flexible resin bonded aluminium oxide cloth for general purpose work shop use.
	200650	P60	75 mm × 2 m	Bett	A flexible resin bonded aluminium oxide cloth for general purpose work shop use. Good wearing ability.
	200722	P60	40 mm × 50 m	Rolls	A flexible resin bonded aluminium oxide cloth for general purpose work shop use.
	200723	P80	40 mm × 50 m	Rolls	A flexible resin bonded aluminium oxide cloth for general purpose work shop use.
	200734	P120	40 mm × 50 m	Rolls	A flexible resin bonded aluminium oxide cloth for general purpose work shop use.
	200810	P180	40 mm × 50 m	Rolls	A flexible resin bonded aluminium oxide cloth for general purpose work shop use.
	200724	P320	40 mm × 50 m	Rolls	A flexible resin bonded aluminium oxide cloth for general purpose work shop use.

INSULATOR PAPER

191379 Insulator Paper

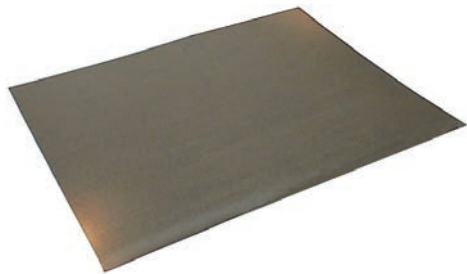

Length: 80 m
Thickness: 0.3 mm
Width: 61.5 mm

Colour: Black
Material: Polyuspan

191443 Insulator Paper



Length: 1150 m
Thickness: 0.5 mm
Width: 950 mm

Colour: Red
Material: Fiber

OIL & GREASE

BEARING GREASE

200746 Molykote br2+ Bearing Grease

Molykote BR 2 plus universal heavy duty grease provides:

- Reduction of wear
- Emergency lubrication
- Higher operational reliability
- Extended lubrication intervals even under high loads and difficult running conditions. Molykote BR 2 plus is suitable for a wide temperature range; it is resistant to oxidation and resist hot and cold water. It also has good corrosion-inhibiting properties.

Range of application

Molykote BR 2 plus can be used wherever grease lubrication is normally applied, e.g. for:

- All types of antifriction bearings
- Plain bearings and guides
- Joints and splined shafts
- Threaded spindles and small gear units at low speeds and all bearings subject to severe impact loads or exposed to extreme atmospheric conditions
- For chassis lubrication on motor vehicles.



Content: 100 g

200748 Molykote 33 Bearing Grease

Molykote 33 is used to lubricate ball and sometimes roller bearings operating under light to moderate loads and at low to medium speeds. Typical applications include: Starter drives, freezer, car casters and cold room conveyor equipment. Maximum demand meters, power factor meters, watt-hour meters, windshield wiper motor gears.



Content: 100 g

200749 Molykote 33 Bearing Grease

Molykote 33 is used to lubricate ball and sometimes roller bearings operating under light to moderate loads and at low to medium speeds. Typical applications include: Starter drives, freezer, car casters and cold room conveyor equipment. Maximum demand meters, power factor meters, watt-hour meters, windshield wiper motor gears.



Content: 1 kg

HEAT TRANSFER COMPOUND

200618 Heat Transfer Compound

Heat transfer grease is a grease-like silicone material heavily filled with heat conductive metal oxides. This material maintains a positive heat sink seal that transfer from electrical and electronic devices to the heat sink or chassis. Used where heat dissipation is required.



Content: 142 g

LUBRICATING OIL

200744 Lubricating Oil

w/ anti-rust additives.



Content: 100 ml

Acid-free: Yes

MULTI PURPOSE GREASE

200745 Multi Purpose Grease

Universal grease for general and industrial use. For small and mediumsized bearings, even under demanding conditions. Has water repellent properties and protects against corrosion. Used in: agricultural machinery, motor wheel bearings, small electric motors, conveyor systems etc.



Content: 200 g

200747 Multi Purpose Grease

Molykote BR 2 plus universal heavy duty grease provides:

- Reduction of wear
- Emergency lubrication
- Higher operational reliability
- Extended lubrication intervals even under high loads and difficult running conditions. Molykote BR 2 plus is suitable for a wide temperature range; it is resistant to oxidation and resist hot and cold water. It also has good corrosion-inhibiting properties.

Range of application

Molykote BR 2 plus can be used wherever grease lubrication is normally applied, e.g. for:

- All types of antifriction bearings
- Plain bearings and guides
- Joints and splined shafts
- Threaded spindles and small gear units at low speeds and all bearings subject to severe impact loads or exposed to extreme atmospheric conditions
- For chassis lubrication on motor vehicles.



Content: 1 kg

DRY BATTERIES
CARBON-ZINK
200735 Battery

Voltage: 1.5

Dim.: 13.9x50 mm

ASA type: AA
 LEC type: R6
 Battery type: Carbon-Zinc
 Heavy duty: Yes
 Mercury: w/o
 Cadmium: w/o

200736 Battery

Voltage: 1.5

Dim.: 26.2x50 mm

ASA type: C
 LEC type: R14
 Battery type: Carbon-Zinc
 Heavy duty: Yes
 Mercury: w/o
 Cadmium: w/o

200737 Battery

Voltage: 1.5

Dim.: 34.2x61.5 mm

ASA type: D
 LEC type: R20
 Battery type: Carbon-Zinc
 Heavy duty: Yes
 Mercury: w/o
 Cadmium: w/o

200796 Battery

Voltage: 6

Dim.: 66x66x111 mm

LEC type: 4R25
 Battery type: Carbon-Zinc
 Heavy duty: Yes

ALKALINE
200601 Battery







Ultra Alkaline 12 V, GP 23AE-C1 Ultra FRP 20/400.



Voltage: 12

Dim.: 10x28 mm

Battery type: Alkaline

	EL. SPECIFICATIONS	DIMENSIONS	ADDITIONAL SPECIFICATIONS
200738 Battery 	Voltage: 1.5	Dim.: 10.5x44.5 mm	ASA type: AAA LEC type: LR03 Battery type: Alkaline Mercury: w/o Cadmium: w/o
200739 Battery 	Voltage: 1.5	Dim.: 14.5x50.5 mm	ASA type: AA LEC type: LR6 Battery type: Alkaline Mercury: w/o Cadmium: w/o
200740 Battery 	Voltage: 1.5	Dim.: 25.4x49.5 mm	ASA type: C LEC type: LR14 Battery type: Alkaline Mercury: w/o Cadmium: w/o
200741 Battery 	Voltage: 1.5	Dim.: 33x60.3 mm	ASA type: D LEC type: LR20 Battery type: Alkaline Mercury: w/o Cadmium: w/o
200742 Battery 	Voltage: 9	Dim.: 25.5x16.5x47 mm	LEC type: 6LR61 Battery type: Alkaline
200792 Battery 	Voltage: 1.5	Dim.: 11.7x29.1 mm	ASA type: N LEC type: LR1 Battery type: Alkaline Mercury: w/o Cadmium: w/o
200808 Battery 	Voltage: 1.5	Dim.: 42.5x8.3 mm	ASA type: AAAA LEC type: LR61 Battery type: Alkaline Mercury: w/o Cadmium: w/o

HIGH VOLTAGE

200776 Battery

Major applications: Electronic instruments, photo and remote control. High voltage. 11 Amp



Voltage: 6

Dim.: 10x16 mm

LEC type: 4LR23
Battery type: Alkaline

200777 Battery

Major applications: Electronic instruments, photo and remote control. High voltage. 27 Amp



Voltage: 12
Miliamp: 27

Dim.: 7.7x28 mm

Battery type: Alkaline

200791 Battery

Major applications: Electronic instruments, photo and remote control. High voltage.



Voltage: 6

Dim.: 13x25.2 mm

LEC type: 4LR44
Battery type: Alkaline

200812 Silver oxide battery

Major application: Eberspächer heater. High voltage.



Voltage: 6

Dim.: 13x25.2 mm

LEC type: 4SR44
Battery type: Mercury

LITHIUM

200828 Lithium Battery

Major applications: Torch light and photo.



Voltage: 3
Miliamp: 1400

Dim.: 16.8x34.5 mm

Battery type: Lithium

200848 Lithium Battery



Voltage: 3
Miliamp: 160

Dim.: 11.6x10 mm

Battery type: Lithium

BUTTON
200772 Battery
Major applications: computer memory backup, photo, remote control and watch.

 Voltage: 3
Miliamp: 90

Dim.: 20x1.6 mm

 LEC type: CR2016
Battery type: Lithium

200773 Battery
Major applications: computer memory backup, photo, remote control and watch.

 Voltage: 3
Miliamp: 36

Dim.: 12.5x2 mm

 LEC type: CR1220
Battery type: Lithium

200774 Battery
Major applications: computer memory backup, photo, remote control and watch.

 Voltage: 3
Miliamp: 160

Dim.: 20x2.5 mm

 LEC type: CR2025
Battery type: Lithium

200775 Battery
Major applications: computer memory backup, photo, remote control, watch and digital sliding gauge.

 Voltage: 3
Miliamp: 220

Dim.: 20x3.2 mm

 LEC type: CR2032
Battery type: Lithium

200778 Battery
Major applications: calculator, photo, remote control and watch.

 Voltage: 1.5
Miliamp: 190

Dim.: 15.6x5.95 mm

 LEC type: LR9
Battery type: Alkaline

200779 Battery
Major applications: calculator, photo, watch and digital sliding gauge.

 Voltage: 1.55
Miliamp: 130

Dim.: 11.6x5.4 mm

 LEC type: SR44
Battery type: Mercury

200802 Battery
Major applications: computer memory backup, photo, remote control, watch and digital sliding gauge.

 Voltage: 3
Miliamp: 7.8

Dim.: 16x2 mm

 LEC type: CR1620
Battery type: Lithium

200813 Battery

Major applications: computer memory backup, photo, remote control and watch.



Voltage: 3
Miliamp: 140

Dim.: 16x3.2 mm

LEC type: CR1632
Battery type: Lithium

200846 Battery

Major application: Eberspächer heater.



Voltage: 3
Miliamp: 300

Dim.: 24x3 mm

LEC type: CR2430
Battery type: Lithium

200854 Battery

Major applications: computer memory backup, photo, remote control and watch.



Voltage: 3
Miliamp: 55

Dim.: 16x1.6 mm

LEC type: CR1616
Battery type: Lithium

200858 Battery

For calculator, photo, clock and IA.



Voltage: 1.5
Miliamp: 160

Dim.: 7.9x3.48 mm

LEC type: LR41
Battery type: Alkaline

200898 Battery

Major applications: computer memory backup, photo, remote control and watch.



Voltage: 3
Miliamp: 610

Dim.: 24.5x5 mm

LEC type: CR2450
Battery type: Lithium

RECHARGEABLE
200765 Battery

Voltage: 1.2
Miliamp: 1000

Dim.: 10.5x44.5 mm







ASA type: AAA
LEC type: RC03
Battery type: NIMH

200766 Battery

Voltage: 1.2
Miliamp: 2600

Dim.: 14.5x50.5 mm

ASA type: AA
LEC type: RC06
Battery type: NIMH

	EL. SPECIFICATIONS	DIMENSIONS	ADDITIONAL SPECIFICATIONS
200768 Battery 	Voltage: 1.2 Milliamp: 2200	Dim.: 34.2x61.5 mm	ASA type: D LEC type: RC20 Battery type: NIMH
200769 Battery 	Voltage: 8.4 Milliamp: 170	Dim.: 15.7x26.5x48 mm	LEC type: 9 V Battery type: NIMH
200851 ReCyco Battery <i>New generation of rechargeable batteries. Recyco batteries have a superior charge retention capability. Comes precharged and ready to use right out of the pack.</i>			
	Voltage: 1.2 Milliamp: 1000	Dim.: 10.5x44.5 mm	ASA type: AAA LEC type: RC03 Battery type: NIMH
200852 ReCyco Battery			
	Voltage: 1.2 Milliamp: 2100	Dim.: 14.5x50 mm	ASA type: AA LEC type: RC06 Battery type: NIMH
<h2>BATTERY CHARGER</h2>			
200771 Battery Charger <i>For AA, AAA, C, D and 9 V NIMH batteries. 7 hours to full charge. w/ automatic timer cut-out on full charge.</i>			
		Dim.: 178x97x57 mm Weight: 0.5 kg	Auto stop: Yes
200853 ReCyco Battery Charger <i>For AA and AAA NIMH batteries. Individual charging channels, damaged battery detection, car charging function, universal voltage for worldwide use. Can charge 1-4 AA batteries or AAA batteries. Supplied w/ 4 pcs AA batteries (HC-CARGO 200852).</i>			
		Dim.: 116x72.5x32 mm Weight: 0.5 kg	Auto stop: Yes

PROTECTING CAPS, TUBES & PLUGS

PROTECTING CAPS

	HC-CARGO	Height	Thread	Colour	Material
	191862	10 mm	M8-1	Red	Polyethylen
	191863	10 mm	M10-1	Red	Polyethylen
	191864	12 mm	M12-1	Red	Polyethylen
	191865	12 mm	M12-1.5	Red	Polyethylen
	191866	11.9 mm	M14-1.5	Yellow	Polyethylen

POLYETHYLEN

	HC-CARGO	OD/cone	ID/cone	Height	Type no.	Colour	Material
	191364	4.8/5.5 mm	3.2/4 mm	5.7 mm	3	Red	Polyethylen
	192131	5/5.9 mm	6.2/7.6 mm	9.5 mm	7	Red	Polyethylen
	191365	6/6.7 mm	4.5/5.3 mm	5.9 mm	5	Red	Polyethylen
	191366	6.8/7.4 mm	5.0/5.6 mm	6.8 mm	6	Red	Polyethylen
	191367	7.6/8.5 mm	6/7.1 mm	8 mm	8	Red	Polyethylen
	191368	8.3/9.4 mm	6.9/7.9 mm	9 mm	10	Red	Polyethylen
	191369	10.1/11 mm	8.2/9.5 mm	9.9 mm	12	Red	Polyethylen
	191370	10.8/12.5 mm	9/10.8 mm	9.6 mm	15	Red	Polyethylen
	191371	11.4/12.8 mm	10.1/11.3 mm	9.8 mm	16	Red	Polyethylen
	191642	12.0/13.8 mm	10.6/12.1 mm	11.1 mm	17	Red	Polyethylen
	191372	13.1/14.5 mm	11.5/13 mm	11.1 mm	18	Red	Polyethylen
	191373	13.9/15.4 mm	12.4/14 mm	12 mm	20	Red	Polyethylen
	191374	14.2/15.7 mm	13/14.7 mm	12.8 mm	25	Red	Polyethylen
	191375	14.9/16.8 mm	14/15.5 mm	12.8 mm	27	Red	Polyethylen
	191480	17.2/18.9 mm	15.8/17.6 mm	14 mm	30	Red	Polyethylen
	191376	18.2/20.2 mm	16.4/18.8 mm	13.9 mm	35	Red	Polyethylen
	191565	20.4/22.5 mm	18.9/20.9 mm	15 mm	37	Red	Polyethylen
191567	24.2/26 mm	22.4/23.5 mm	13.7 mm	41	Red	Polyethylen	
192756	27.5/28.6 mm	25.3/26.7 mm	13.7 mm	44	Red	Polypropylene	

POLYETHYLEN







	HC-CARGO	ID	Height	Type no.	Colour	Material
	192988	4.8 mm	12.8 mm		Black	EPDM rubber

POLYETHYLEN

	HC-CARGO	ID	Height	Type no.	Colour	Material
	191675	30 mm	29 mm	30	Yellow	Polyethylen

PROTECTING PLUGS

	HC-CARGO	Thread	Colour	Material
	191857	M8-1	Red	Polyethylen
	191858	M10-1	Red	Polyethylen
	191859	M12-1	Red	Polyethylen
	191860	M12-1.5	Red	Polyethylen
	191861	M14-1.5	Red	Polyethylen

PROTECTING TUBES					
PLASTIC					
	HC-CARGO	ID	OD	Colour	Material
	191392	10 mm	14 mm	Transparent	Plastic
	192773	8 mm	13.9 mm	Red	
PAPER					
	HC-CARGO	ID	OD	Material	
	191390	16.4 mm	18.4 mm	Cardboard	
	191391	19.5 mm	22.4 mm	Cardboard	
RUBBER BOOTS					
191616 Rubbe Boot "denka lift"				Std pkg 150	
			ID: 25 mm ID/cone: 63 mm Length: 80 mm		
ASSEMBLY PARTS					
SEALS & GASKETS					
080751 Seal Wire					
			Length: 210 mm		
081006 Seal					
			OD: 9 mm	Colour: Red Material: Plastic	
JOINTS					
ANGLE					
	HC-CARGO	Thread			
	080653	M5-0.8	Type AS w/ threaded journal, hex nut and lock pin. DIN 71802.		
	080628	M6x1	Type AS w/ threaded journal, hex nut and lock pin. DIN 71802.		
	080629	M6x1	Type AS w/ threaded journal, hex nut and lock pin. DIN 71802.		
	080630	M6x1x10	Type AS w/ threaded journal, hex nut and lock pin. DIN 71802.		
	080654	M6x1x10	Type AS w/ threaded journal, hex nut and lock pin. DIN 71802.		
	080631	M8x1.25	Type AS w/ threaded journal, hex nut and lock pin. DIN 71802.		
	080655	M8x1.25	Type AS w/ threaded journal, hex nut and lock pin. DIN 71802.		
	080656	M10x1.5	Type AS w/ threaded journal, hex nut and lock pin. DIN 71802.		
	080657	M12x1.75	Type AS w/ threaded journal, hex nut and lock pin. DIN 71802.		

FORK BOLTS

	HC-CARGO	OD	Length
	080864	5 mm	20 mm
	080662	6 mm	18 mm
	080663	8 mm	22 mm
	080664	10 mm	28 mm
	080665	12 mm	35 mm
	080666	14 mm	40 mm

IN LINE

	HC-CARGO	Thread
	080744	M6-1
	080745	M8-1

FORK HEADS

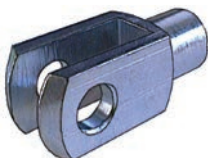
	HC-CARGO	Thread	Length	Slot wide
	080843	M5	10 mm	5 mm
	080863	M5	20 mm	5 mm
	080659	M6	12 mm	6 mm
	080660	M8	16 mm	8 mm
	080661	M8	32 mm	8 mm

HOSE NIPPLES

	HC-CARGO	Hose ID	Length
	080274	5 mm	26 mm
	080275	8 mm	32 mm
	080276	10 mm	34 mm

DOUBLE

	HC-CARGO	Bore	Hose ID
	080799	6 mm	4 mm
	080245	8 mm	6 mm
	080859	10 mm	6 mm
	080246	12 mm	8 mm
	080247	14 mm	10 mm

DIN 7622

	HC-CARGO	Bore	Hose ID
	080860	1/2"	8 mm
	080794	6 mm	4 mm
	080795	8 mm	4 mm
	080237	8 mm	6 mm
	080239	10 mm	7 mm
	080678	10 mm	8 mm
	080240	12 mm	7 mm
	080241	12 mm	9 mm
	080679	12 mm	10 mm
	080238	14 mm	6 mm
	080242	14 mm	9 mm
	080243	14 mm	11 mm
	080826	14 mm	12 mm
	080002	16 mm	10 mm
	080003	16 mm	12 mm

T-CONNECTOR				
	HC-CARGO	Hose ID	Material	
	080836	4 mm	Steel	
	080838	6 mm	Steel	
	080839	8 mm	Steel	
	081220	10 mm	Steel	
PIPE NIPPLES				
	HC-CARGO	ID	Hose ID	
	080269	3 mm	5 mm	
	080270	4 mm	6 mm	
	080271	6 mm	8 mm	
	080272	8 mm	10 mm	
	080273	10 mm	12 mm	
HOLLOW SCREWS				
	HC-CARGO	Thread	Bore	
	080812	1/2 " -20 UNF	6 mm	
	080575	M6-1		
	080251	M8-1	4.2 mm	
	080001	M10-1.25	4 mm	
	080253	M10-1.5	4 mm	
	080252	M10-10	4 mm	
	081116	M10x1.5	4 mm	
	080254	M12-1.5	6 mm	
	080255	M14-1.5	8 mm	
	080731	M16-1.5	11 mm	
	080256	M16-1.5	9 mm	
	DOUBLE			
	HC-CARGO	Thread	Bore	
	080257	M8-1	2 mm	
	080258	M14-1.5	8 mm	
EYE UNION				
SOLDER				
	HC-CARGO	Bore	Pipe OD	
	080298	16 mm	12 mm	
POLYAMID TUBES				
	HC-CARGO	Bore	Hose ID	
	080625	12 mm	6 mm	
	080626	12 mm	8 mm	
	080627	14 mm	6 mm	
	080283	14 mm	8 mm	
	080284	14 mm	10 mm	

RETAINING RINGS FOR SHAFT AND BORES

LOCK RINGS

EXTERNAL

	HC-CARGO	OD housing	DIN norm	Material
	192751	6 mm	471	Steel spring
	191799	14 mm	471	Steel spring
	191270	15 mm	471	Steel spring
	192524	16 mm	471	Steel spring
	191816	17 mm	471	Steel spring
	191271	18 mm	471	Steel spring
	191333	19 mm	471	Steel spring
	191272	20 mm	471	Steel spring
	191273	21 mm	471	Steel spring
	191274	22 mm	471	Steel spring
	191481	23 mm	471	Steel spring
	191275	24 mm	471	Steel spring
	191276	25 mm	471	Steel spring
	191914	26 mm	471	Steel spring
191433	27 mm	471	Steel spring	

CIRCLIPS

	HC-CARGO	OD housing	DIN norm	Material
	191277	3.2 mm	6799	Steel spring
	192707	4 mm	6799	Steel spring
	191278	6 mm	6799	Steel spring
	191573	7 mm	6799	Steel spring
	191279	8 mm	6799	Steel spring
	191280	9 mm	6799	Steel spring
	192507	15 mm	6799	Steel spring

LOCK WASHERS

	HC-CARGO	OD housing	Material
	192144	8 mm	Steel spring

SPRING PINS

135061 Spring Pin

For mounting bushing.



ID: 11.5 mm
OD: 14 mm
Length: 50 mm

192814 Spring Pin



ID: 8.5 mm
OD: 10.5 mm
Length: 14 mm

Material: Steel spring
Heat treated: Yes
Heavy duty: No
DIN norm: 7336
ISO norm: 13337

230858 Spring Pin



ID: 8 mm
OD: 10 mm
Length: 25.4 mm

Material: Steel spring
Heat treated: Yes
Heavy duty: No
DIN norm: 7336
ISO norm: 13337

BRASS OLIVES

	HC-CARGO	ID	OD
	080277	4.1 mm	4 mm
	080278	5.1 mm	5 mm
	080279	6.1 mm	6 mm
	080280	8.1 mm	8 mm
	080281	10.1 mm	10 mm
	080282	12.1 mm	12 mm

TOOLS

HSS DRILLS

TWIST

	HC-CARGO	OD	DIN norm	Material	Type
	210141	1 mm	338	High Speed Steel	N
	210142	1.5 mm	338	High Speed Steel	N
	210143	2 mm	338	High Speed Steel	N
	210144	2.5 mm	338	High Speed Steel	N
	210145	3 mm	338	High Speed Steel	N
	210146	3.3 mm	338	High Speed Steel	N
	210164	3.5 mm	338	High Speed Steel	N
	210147	4 mm	338	High Speed Steel	N
	210691	4.2 mm	338	High Speed Steel	N
	210148	4.5 mm	338	High Speed Steel	N
	210149	5 mm	338	High Speed Steel	N
	210150	5.5 mm	338	High Speed Steel	N
	210151	6 mm	338	High Speed Steel	N
	210152	6.5 mm	338	High Speed Steel	N
	210153	7 mm	338	High Speed Steel	N
	210154	7.5 mm	338	High Speed Steel	N
	210155	8 mm	338	High Speed Steel	N
	210156	8.5 mm	338	High Speed Steel	N
	210157	9 mm	338	High Speed Steel	N
210158	9.5 mm	338	High Speed Steel	N	
210159	10 mm	338	High Speed Steel	N	
210160	10.5 mm	338	High Speed Steel	N	

TWIST, DOUBLED ENDED

	HC-CARGO	OD	Material
	210692	3.3 mm	High Speed Steel

ASSORTMENT

210140 Drill Assortment

Contains 19 drills from 1-10 mm.



Type: HSS

SOLDERING

SOLDER

200838 Solder

99.3% tin. 0.7% copper. Unleaded.



Content: 1 kg

200850 Solder

99.3% tin. 0.7% copper. Unleaded.



Content: 500 g

SILVER

200790 Ribbon Silver Solder

125 g.



Width: 6 mm

FLUX

200720 Soldering Flux

Concentrated, can be diluted w/ water up to 4 L. For coarse surfaces. Eg. drain pipes.



Content: 1 L

Acid-free: Yes

IRONS

210897 Soldering Iron

HRT soldering irons are a patented technical innovation. An armoured heating element of very compact design is located in the heart of the tip and compared to the traditional method, this provides: A reduction of energy consumption by 25 to 35 % at equivalent power. 230 V. AC. Soldering capacity: Wires max. 7 mm, metal max. 7 mm. Tip: HC-CARGO 210903.



Voltage: 230
Watt: 75

210898 Soldering Iron

HRT soldering irons are a patented technical innovation. An armoured heating element of very compact design is located in the heart of the tip and compared to the traditional method, this provides: A reduction of energy consumption by 25 to 35 % at equivalent power. 230 V. AC. Soldering capacity: Wires max. 9 mm, metal max. 12 mm. Tip: HC-CARGO 210904. Heating element: HC-CARGO 210901.



Voltage: 230
Watt: 100

210899 Soldering Iron

HRT soldering irons are a patented technical innovation. An armoured teating element of very compact design is located in the heart of the tip and compared to the traditional method, this provides: A reduction of energy consumption by 25 to 35 % at equivalent power. 230 V. AC. Soldering capacity: Wires max. 12 mm, metal max. 15 mm. Tip: HC-CARGO 210904. Heating element: HC-CARGO 210902.



Voltage: 230
Watt: 125

210910 Soldering Iron

HRT soldering irons are a patented technical innovation. An armoured teating element of very compact design is located in the heart of the tip and compared to the traditional method, this provides: A reduction of energy consumption by 25 to 35 % at equivalent power. 230 V. AC. Soldering capacity: Wires max. 13 mm, metal max. 22 mm. Tip: HC-CARGO 210912. Heating element: HC-CARGO 210911.



Voltage: 230
Watt: 200

211090 Soldering Gun

Tip: HC-CARGO 211092.



Voltage: 230
Watt: 250

211106 Gas Soldering Iron

Max. temperature 1371°C when used as a torch. Max. temperatur 510°C, when used for soldering. Tip: HC-CARGO 211107, -108, -109, -110.



SPARE PARTS

210901 Heating Element

Servicing: HC-CARGO 210898



Voltage: 230
Watt: 100

210902 Heating Element

Servicing: HC-CARGO 210899





Voltage: 230
Watt: 125

210903 Soldering Tip

Servicing: HC-CARGO 210897



	EL. SPECIFICATIONS	DIMENSIONS	ADDITIONAL SPECIFICATIONS
210904 Soldering Tip 	Servicing: HC-CARGO 210898, 210899		
210911 Heating Element 	Servicing: HC-CARGO 210910 Voltage: 230 Watt: 200		
210912 Soldering Tip 	Servicing: HC-CARGO 210910		
211092 Soldering Tip <i>For soldering gun.</i> 	Servicing: HC-CARGO 211090 Voltage: 230 Watt: 250		
211107 Soldering Tip 	Servicing: HC-CARGO 211106		
211108 Chisel Tip 	Servicing: HC-CARGO 211106		
211109 Soldering Tip <i>Wedge-shaped.</i> 	Servicing: HC-CARGO 211106		
211110 Hot Knife 	Servicing: HC-CARGO 211106		

WORK GLOVES

LEATHER

	HC-CARGO	Size	Approval	Material	Colour	
	200140	9	CE	Grain palm leather	Yellow	w/ Cuff
	200141	10	CE	Grain palm leather	Blue	w/ Cuff
	200142	11	CE	Grain palm leather	Yellow	w/ Cuff
	200526	10	CE	Grain palm leather	Red	<i>Shoulded spilt palm.</i>
	200527	11	CE	Grain palm leather	Red	

RUBBER

	HC-CARGO	Size	Approval	Material	Colour	
	200621	10	CE	Rubber	Blue	
	200622	11	CE	Rubber	Blue	

	HC-CARGO	Size	Approval	Material	Colour	
	200686	10	CE	Rubber	Black	<i>Strong quality. For short-blastning etc. Length 44 cm</i>
	200787	10	CE	Rubber	Black	<i>Strong quality. For short-blastning etc. Length 60 cm</i>

	HC-CARGO	Size	Approval	Material	Colour	
	200831	7	CE	Nitrile	Blue	
	200832	8	CE	Nitrile	Blue	
	200833	9	CE	Nitrile	Blue	
	200834	10	CE	Nitrile	Blue	

	HC-CARGO	Size	Approval	Material	Colour	
	200889	7		Polyurethan	Red	
	200884	8		Polyurethan	Red	
	200885	9		Polyurethan	Red	
	200886	10		Polyurethan	Red	
	200887	11		Polyurethan	Red	

	HC-CARGO	Size	Approval	Material	Colour	
	200890	S	CE	Polyurethan	Grey	
	200891	M	CE	Polyurethan	Grey	
	200892	I	CE	Polyurethan	Grey	
	200893	XL	CE	Polyurethan	Grey	
	200897	XXL	CE	Polyurethan	Grey	

COTTON & VINYL

	HC-CARGO	Size	Approval	Material	Colour	
	200603	6	CE	Cotton	White	
	200805	8	CE	Cotton	White	
	200640	10	CE	Cotton	White	

	HC-CARGO	Size	Approval	Material	Colour	
	200655	8	CE	Nitrile	White/Grey	w/ rib.
	200685	10	CE	Nitrile	White/Grey	w/ rib.
	HC-CARGO	Size	Approval	Material	Colour	
	200866	7	CE	Vinyl	Transparent	
	200867	8	CE	Vinyl	Transparent	
	200868	9	CE	Vinyl	Transparent	
	200869	10	CE	Vinyl		

LATEX

	HC-CARGO	Size	Approval	Material	Colour	
	200687	8	CE	Latex	Nature	Universal.
	200688	9	CE	Latex	Nature	Universal.

SAFETY GLASSES

253488 UV Glasses



Size: One size

PROTECTING MASKS

200127 Protective Face Mask

Protects against solid and liquid particles. Offers no protection against gases, vapours or oxygen deficiency. Maintenance-free.



Class: FFP2S
Approval: EN149

200144 Protective Face Mask

Protects against solid particles bigger than 5 mg/m³. Offers no protection against liquid particles, gasses, vapours or oxygen deficiency.







Disposable mask: Yes
Class: FFP1S
Approval: EN149

200624 Protective Face Mask

Protects against solid particles bigger than 5 mg/m³. Offers no protection against liquid particles, gasses, vapours or oxygen deficiency.



Disposable mask: Yes
Class: FFP2S
Approval: EN149

THREADED INSERTS						
	HC-CARGO	Internal thread	External thread	Length	DIN Norm	
	192578	M10-1	M12-1	10		<i>For glow plugs. Machine tap: HC-CARGO 211063.</i>
	192346	M10	M14	18	7168	<i>Can be used in light metal alloys, cast iron, brass, bronze, NF metals, plastic and hard woods.</i>
	192531	M10x1.25	M14	18	7168	<i>Can be used in light metal alloys, cast iron, brass, bronze, NF metals, plastic and hard woods.</i>
WIRE THREAD						
	HC-CARGO	Thread	Length			
	200698	M4	6 mm			<i>For repairing or creating stronger threads.</i>
	200699	M4	8 mm			<i>For repairing or creating stronger threads.</i>
	200700	M5	7.5 mm			<i>For repairing or creating stronger threads.</i>
	200701	M5	10 mm			<i>For repairing or creating stronger threads.</i>
	200703	M6	12 mm			<i>For repairing or creating stronger threads.</i>
	200704	M7	10.5 mm			<i>For repairing or creating stronger threads.</i>
	200706	M8	12 mm			<i>For repairing or creating stronger threads.</i>
	200707	M8	16 mm			<i>For repairing or creating stronger threads.</i>
	200708	M8	20 mm			<i>For repairing or creating stronger threads.</i>
	200709	M10	15 mm			<i>For repairing or creating stronger threads.</i>
	200710	M10	20 mm			<i>For repairing or creating stronger threads.</i>
	200712	M10-1.25	20 mm			<i>For repairing or creating stronger threads.</i>
	200711	M12	18 mm			<i>For repairing or creating stronger threads.</i>
200713	M12-1.25	18 mm			<i>For repairing or creating stronger threads.</i>	
MACHINE TAPS						
	HC-CARGO	Thread	Length			
	210812	M4	50 mm			<i>For threaded inserts.</i>
	210813	M5	50 mm			<i>For threaded inserts.</i>
	210814	M6	56 mm			<i>For threaded inserts.</i>
	210816	M8	70 mm			<i>For threaded inserts.</i>
	210817	M10	75 mm			<i>For threaded inserts.</i>
	210818	M12	80 mm			<i>For threaded inserts.</i>
	210820	M12-1.25	70 mm			<i>For threaded inserts.</i>
	210822	M12-1.5	70 mm			<i>For threaded inserts.</i>
	210936	M14-1.5	70 mm			<i>For threaded inserts.</i>
	DIES AND TAPS					
MACHINE						
	HC-CARGO	Thread		DIN Norm		
	210789	M4		376		<i>Form A, HSS.</i>
	210790	M5		376		<i>Form A, HSS.</i>
	210791	M6		376		<i>Form A, HSS.</i>
	210793	M8		376		<i>Form A, HSS.</i>
	210794	M10		376		<i>Form A, HSS.</i>
ROUND						
	HC-CARGO	Thread		OD		
	210809	M17-1.5		45x14 mm		<i>DIN 13. HSS.</i>

HOSE CLAMP SCREWDRIVERS

210249 Hose Clamp Screwdriver

Flexible. 7 mm



COMBI TOOLS

210050 Multi Tool

Pulley: HC-CARGO 330716.



210051 Multi Tool

Servicing: HC-CARGO 330716

To be used w/ HC-CARGO 210050.



210843 Combi Tool

Servicing: Bosch Alternators

33 teeth combi tool for the disassembly and assembly of the free wheel pulley. XZN 10x110 mm, w/ 1/2" socket and 22 mm hexagon.



210873 Combi Tool

Servicing: Magneti Marelli - Visit www.hc-cargo.com for further information

For removing and installing of rubber clutch pulley. 200 mm spec. tool + 8x100 mm allen wrench w/ 1/2" socket.



210877 Combi Tool

Servicing: Bosch

For removing and installing of rubber clutch pulley. XZN 10x112 mm w/ 1/2" socket and 30/28 mm hexagon.

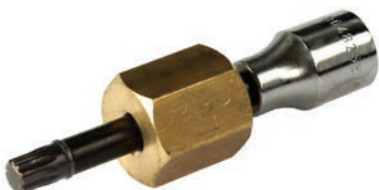

210909 Combi Tool

Servicing: Valeo Alternators

33 teeth combitool for disassembly and assembly of free wheel pulley. Torx 50x110 mm, w/ 1/2" socket and 22 mm hexagon.



EL. SPECIFICATIONS

DIMENSIONS

ADDITIONAL SPECIFICATIONS

210948 Combi Tool Servicing: Audi, VW, MB, SEAT, Skoda - Visit www.hc-cargo.com for further information
33 teeth combi tool for the disassembly and assembly of the free wheel pulley, XZN 10x135 mm, w/ 1/2" socket and 22 mm hexagon.



211048 Combitool MK2 Servicing: Generators - Visit www.hc-cargo.com for further information



211049 Combitool MK3 Servicing: Generators - Visit www.hc-cargo.com for further information



211081 Combi Tool Servicing: Valeo
For removing and installing of rubber clutch pulley. XZN 10x128 mm w/ 1/2" socket and 28/19 mm hexagon.



LAMBDA SENSOR TOOL

210763 Oxygen Sensor Tool
Special tool for mounting/removing oxygen sensors.



Thread type: M18

TUBE BENDERS

090117 Tube Bender Tool
w/ interchangeable formers for tubes O.D. 6, 8, 10 and 12 mm.



REMOVE/INSTALL

IMPACT PULLER

210788 Injector Tool

Suitable for extraction of needle/roller bearings, ball bearings, brass sleeves and flame arresters.



INTERNAL EXTRACTORS

210777 Internal Extractor 5-7 mm

Suitable for extraction of needle/roller bearings, ball bearings, brass sleeves and flame arresters.



210778 Internal Extractor 7-9 mm

Suitable for extraction of needle/roller bearings, ball bearings, brass sleeves and flame arresters.



210779 Internal Extractor 9-12 mm

Suitable for extraction of needle/roller bearings, ball bearings, brass sleeves and flame arresters.



210780 Internal Extractor 10-13 mm

Suitable for extraction of needle/roller bearings, ball bearings, brass sleeves and flame arresters.



210781 Internal Extractor 13-17 mm

Suitable for extraction of needle/roller bearings, ball bearings, brass sleeves and flame arresters.



210782 Internal Extractor 14-19 mm

Suitable for extraction of needle/roller bearings, ball bearings, brass sleeves and flame arresters.



210786 Internal Extractor 25-30 mm

Suitable for extraction of needle/roller bearings, ball bearings, brass sleeves and flame arresters.



UNIVERSAL PULLER

210868 Universal Puller

w/ slender hooks. Min. - max. 10-80 mm.



SOLENOID TOOLS

210686 Solenoid Tool

Makes opening and closing Bosch, Bosch industrial, hitachi and mitsubishi passenger car "crimp cap" -solenoids a fast and simple press operation. Complete set in carrying box.



SOLENOID COIL

210566 Mounting Sleeve



210567 Mounting Sleeve

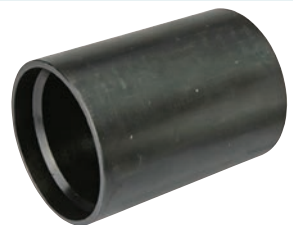

DRIVE TOOLS

210867 Assembly Tool

Tool for renewing of new type Bosch starter. For mounting of repair kit: HC-CARGO 136856.



210995 Mounting Pin

Servicing: HC-CARGO 210867

 OD: 13 mm
 Length: 70 mm

210996 Mounting Pin

Servicing: HC-CARGO 210867

 OD: 13 mm
 Length: 70 mm

ADJUSTMENT TOOLS

090153 Test Kit

 Servicing: Opel, VAG, Ford, Volvo, (TDI), Japanese applications - Visit www.hc-cargo.com for further information

Content: Micrometers O.D. 41 mm, 0.01-5 mm. Mount micrometer: length 38 mm. Extension for micrometer: length 42 mm. Extension for micrometer: length 101 mm. Extender w/ M8-1. Extension cradle M10-1. align tool (VAG). dorn (VAG).



TEST INJECTION PIPES

	HC-CARGO	Screw device	Wall thickness	Dim.
	090255	12&14	2 mm	6 mm × 2 mm × 600 mm
	090325	12&14	2 mm	6 mm × 2 mm × 840 mm
	090257	14&14	1.5 mm	6 mm × 3 mm × 600 mm
	090292	14&14	2.5 mm	8 mm × 3 mm × 600 mm

SPECIAL TOOLS

080724 Nozzle Holder Tool

Tools for Mercedes nozzle holder.



081169 Repair Kit Injectors

 Servicing: Common Rail injectors - Visit www.hc-cargo.com for further information

090133 Injector Tester

Filter: HC-CARGO 090259.

 Dim.: 200x516 mm
 Piston cycle: 10.5
 OD: 14 mm
 Fuel cap: 3.2 l
 Working pressure:
 0-40 MPa
 Test quantity: 1600 mm²
 Weight: 15 kg

EL. SPECIFICATIONS	DIMENSIONS	ADDITIONAL SPECIFICATIONS
<p>090239 Quick Release Tool Servicing: HC-CARGO 090133.</p> <p><i>Quick connector to the nozzle tester 12x1.5 mm/14x1.5 mm.</i></p>		
		
<p>090241 Wrench Servicing: Bosch VE pump, Audi, BMW - Visit www.hc-cargo.com for further information</p> <p><i>For screwhead O.D. 7.5 mm.</i></p>		
		
<p>090269 Glow Plug Tool</p> <p><i>Tool set for the drilling of broken off CDI glow plugs M10-1. Contains: torx top E10, 3/8". Single-purpose drill w/ counterbore I.D. 9 mm turned from 5.4 to 4 mm. Special retainer for single-purpose drill. Drill and extraction housing for glow plugs locked.</i></p>		
		
<p>090273 Glow Plug Drill Servicing: HC-CARGO 090269</p> <p><i>9 mm to 5.4 mm to 4 mm.</i></p>		
		
<p>090282 Wrench Servicing: DPC</p> <p><i>Triangular.</i></p>		
		
<p>090285 Socket Wrench Servicing: DPC</p>		
		
<p>090287 Wrench</p> <p><i>17-17 mm. For injection pipes.</i></p>		
		

090288 Socket Wrench

27 mm. For injection w /sensors.



090301 Extraction Tool

Servicing: Universal - Visit www.hc-cargo.com for further information

Tool set for the drilling of broken off glow plugs M12-1.5. Contains: Torx top E10, 3/8". Single purpose drill w/ counterbore ID 10.75 mm turned from 6 to 5 mm drill and extraction housing for glow plugs locked in the hole. Screw tap HSSG UNF 1/4" DIN 351. Tool holder w/ long ratchet for M3-M8. Thread adaptor UNF 1/4": M16-1.5 w/ extraction nut. Bearing adaptor w/ bore ID 16 mm. Screw tap hmb M12-1.5 RSPI 354 plug tap.



090305 Extraction Adapter

Servicing: HC-CARGO 090269

1/4" extraction adapter.



090327 Reamer Tool

Servicing: Mercedes - Visit www.hc-cargo.com for further information

To repair/clean the injector seat and measure the deep in the seat to get the right flame arrest (the right thickness).



090335 Extraction Adapter

Servicing: HC-CARGO 090301

5/16" for glow plugs.



090349 Special Drill

Servicing: HC-CARGO 090301

Single purpose drill w/ counterbore. I.D. 10.75 mm turned from 6 to 5 mm.



090355 Wrench

Servicing: HC-CARGO 090269

Long ratchet to cut tabs.



090372 Hose Press

Presses from 6-18 mm O.D.



090407 Lapping Tool

Lapping kit that also enable to rebuild the seat of the conic seat of the closing valve positioned under the c.r. injector solenoids. For common rail injectors.



090409 CR Return Flow Meter

For measuring af back lift on CR nozzles.



090434 Tool kit

Kit for cleaning nozzle seats in the cylinder head and planing plant surfaces of nozzles.



KIT

090296 Extraction Tool

Servicing: Mercedes CDI - Visit www.hc-cargo.com for further information

Includes: 1 threaded hole protector. 2 fork (HC-CARGO 090322). 3 guidetubes. 4 short piston rods. 5 long piston rods. 6 press-on nuts. 7 handles. 8 proctive caps.



SPARE PARTS

090259 Glass Bowl Kit

Servicing: HC-CARGO 090133



090357 Drill Guide Bushing

Servicing: HC-CARGO 090269

090438 Brass Brush

Servicing: HC-CARGO 090327



OD: 6 mm

WORKS AND TEST EQUIPMENT

ANTIFREEZE HYDROMETERS

210052 Antifreeze Tester

Glykomat, for ethyleneglycol.

210053 Antifreeze Tester

Gefo Coldomat, for ethyleneglycol.

BATTERY ACID HYDROMETERS

210134 Battery Acid Tester

REFRACTOMETERS

210771 Refractometer

Ethylene glycol, propylene glycol, battery liquid, windshield washer fluid.

TEST PLUGS

210054 Test Plug

The test lead makes it possible for one person alone to control the socket from the drivers seat.



Voltage: 12

Length/test cable: 5 m

Plug type: 7, 12N
ISO norm: 1724
DIN norm: 72577
Test cable incl.: Yes

210758 Test Plug

Servicing: Commercial vehicles w/ w/o CAN-BUS/check control system - Visit www.hc-cargo.com for further information

The test lead makes it possible for one person alone to control the socket from the drivers seat.



Voltage: 12

Length/test cable: 5 m

Plug type 1: 13
ISO norm 1: 11446
DIN norm 1: 72570
Plug type 2: 7, 12N
ISO norm 2: 1724
DIN norm 2: 72577
Plug type 3: 7/13, Multicon
Can-Bus: Yes
Test cable incl.: Yes

210869 Test Plug



Voltage: 12

Plug type: 7, 12N
ISO norm: 1724
DIN norm: 72577

210871 Test Plug



Voltage: 12

Plug type: 13
ISO norm: 11446
DIN norm: 72570

210872 Test Plug

The test lead of 5 m allows one person to check the socket from the drivers seat.



Voltage: 12

Length/test cable: 5 m

Plug type: 13
ISO norm: 11446
DIN norm: 72570
Test cable incl.: Yes

211059 Adaptor

Servicing: HC-CARGO 211058

w/ this adaptor you can use HC-CARGO 211058 for check of 7 pole and 7/13 multicon sockets.



Voltage: 12

Plug type 1: 7/13, Multicon
Plug type 2: 7, 12N
ISO norm: 1724
DIN norm: 72577

W/LOAD
211058 Trailer Socket Tester

Servicing: Commercial vehicles w/ w/o CAN-BUS/check control system - Visit www.hc-cargo.com for further information

Accessories: HC-CARGO 211059.



Voltage: 12

Length/test cable: 5 m

Plug type: 13
ISO norm: 11446
DIN norm: 72570
Can-Bus: Yes
Test cable incl.: Yes

TRAILER LIGHT TESTER
211113 Trailer Lighttester 7-pole

Used for testing, faultfinding and repair of light installation of trailers, caravans and cars w/o CAN-BUS. Provided w/ built in battery and charger.



Voltage: 12

Dim.: 225x120 mm

Plug type: 7
ISO norm: 1724
DIN norm: 72577
Colour: White
Material: ABS plastic
Can-Bus: No
Warning lamp: Yes
Batteries incl.: Yes

211114 Trailer Light Tester

Testing of light installation on a trailer and caravans w/o CAN-BUS. w/ built-in battery. Comes w/ charger. 13 poles.



Voltage: 12

Dim.: 225x120 mm

Plug type: 13
ISO norm: 4091
DIN norm: 72570
Colour: White
Material: ABS plastic
Can-Bus: No
Warning lamp: Yes
Batteries incl.: Yes

OXYGEN SENSOR TESTER
210762 Oxygen Sensor Tester

Shows if the oxygen sensor is active.

BLADES
210699 Blades

ID: 3.2 mm
OD: 7.86 mm
Thread: 0.4

DIGITAL MULTIMETER

210977 Digital Multimeter

Servicing: HC-CARGO 200742

3.5 digital LCD display.



Voltage/AC: 200V/600V
 Voltage/DC 1: 200mV/2/20
 /200/600V
 Amp/DC: 0.2/2/20 /200mA/15A
 Ohm: 200 hm/2/20 /200/2000 K
 Ohm

Dim.: 74x145x40 mm
 Reading/max: 1999

Colour: Black
 Material: Plastic
 HFE transistor: Yes
 Batteries incl.: Yes
 Battery check: Yes
 Diode check: Yes
 Test cable incl.: Yes
 Approval: CE

211065 AC/DC Clamp Multimeter

 Servicing: CE/LVD CAT III 600 V - Visit www.hc-cargo.com for further information

3 3/4 Digits compact clamp and multimeter for measuring ampere as well as DC & AC voltage.



Voltage/AC: 4/40/400V
 /±1.0%, 40/400mV /600V±1.5%
 Amp/AC: 400A±2.0%, 1000A±2.5%
 Voltage/DC 1: 400mV/4/40
 /400V±0.5%, 40mV/600V±0.8%
 Amp/DC: 400A±1.5%, 1000A±2%
 Ohm: 400ohm/4/40 /400kohm
 /4Mohm±1.0%, 40Mohm±2%
 Frequency: 1Hz--10MHz±0.1%

Dim.: 220x64x35 mm
 Temp.: -20°C - +150°C
 Reading/max: 4000
 Capacity: 40nF±3%, 400nF
 /4µF±2.5%, 40µF±5%,
 400/4000µF±20%

Batteries incl.: Yes
 Battery check: Yes
 Diode check: Yes
 Continuity test: Yes
 Reading: Yes
 LCD display: Yes
 C°/F° selection: Yes
 Auto power off: Yes
 Approval: CE

211101 Smart Multimeter SD-5803

Test leads: HC-CARGO 210980. Fuse: HC-CARGO 192862.



Voltage/AC: 4/40/400V±0.8%,
 400mV/600V±1.2%
 Voltage/DC 1: 4/40/400V±0.5%,
 600V±0.8%
 Ohm: 400ohm/4/40 /400kohm/
 4Mohm±1%, 40Mohm±2%
 Frequency: 1Hz--500kHz±0.1%

Dim.: 152x78x33 mm
 Temp.: 0°C - +40°C
 Duty cycle: 0.1%-99.9±2.5%
 Reading/max: 4000
 Capacity: 40nF/400nF/4µF
 /40µF±3%,
 400µF/4000µF±20%

Batteries incl.: Yes
 Diode check: Yes
 Continuity test: Yes
 Reading: Yes
 Test cable incl.: Yes
 LCD display: Yes
 Smart function: Yes
 Auto power off: Yes
 Approval: CE

211102 Smart Multimeter SD-5813

CE/LVD CAT III 500 V. Test cable: HC-CARGO 210980. Fuses: HC-CARGO 190285, 192861.



Voltage/AC: 4/40/400V±0.8%,
 400mV/500V±1.2%
 Amp/AC: 40/400mA±2.0%,
 4/10A±2.5%
 Voltage/DC 1: ±400mV/4/40
 /400V±0.5%, ±500V±0.8%
 Amp/DC: 40/400mA±1.2%,
 4/10A±2.0%
 Ohm: 400ohm/4/40 /400kohm/
 4Mohm±1.0%, 40Mohm±2.0%
 Frequency: 1Hz--500kHz±0.1%

Dim.: 165x83x37 mm
 RPM: (0-10.000RPM)±0.1%
 Duty cycle: 0.1%-99.9±2.0%
 Dwell angle: ±2%
 Temp.: -50°C - +150°C
 Reading/max: 4000
 Capacity: 40nF±3%, 400nF
 /4µF±2.5%, 40µF±5%,
 400/4000µF±20%

Batteries incl.: Yes
 Battery check: Yes
 Diode check: Yes
 Continuity test: Yes
 Reading: Yes
 Test cable incl.: Yes
 LCD display: Yes
 C°/F° selection: Yes
 Smart function: Yes
 Auto power off: Yes
 Approval: CE

SPARE PARTS

210980 Test Lead

Servicing: HC-CARGO 210977, 211065, 211101, 211102



INFRARED THERMOMETER

211080 Infrared Thermometer

Used for measurement of surface temperatures which are not suitable for physical contact: 1. high voltage areas, 2. high temperature non-touchable objects. 3. moving objects.



Temp.: -20°C - +320°C
 (-4°F - +600°F)

Batteries incl.: Yes
 H/L indicator: Yes
 Reading: Yes
 LCD display: Yes
 C°/F° selection: Yes
 Auto power off: Yes

211128 Infrared Thermometer

Used for measurement of surface temperatures which are not suitable for physical contact: 1. high voltage areas, 2. high temperature non-touchable objects. 3. moving objects.

NEW PRODUCT
www.hc-cargo.com

Dim.: 153x101x143 mm
Temp.: -50°C - 380°C
(-58°F - 716°F)
Weight: 0.147 kg

Batteries incl.: Yes
Reading: Yes
LCD display: Yes
C°/F° selection: Yes
Auto power off: Yes

ACCESSORIES

ALLIGATOR CLIPS

211013 Alligator Clip

Connection for test probes.



Amp: 5

Jaw opening: 11
Length: 50 mm

Type: Positive
Colour: Red

211014 Alligator Clip

Connection for test probes.



Amp: 5

Jaw opening: 11
Length: 50 mm

Type: Negative
Colour: Black

TEST BOX

210878 Tester

Servicing: Magneti Marelli, Ford - Visit www.hc-cargo.com for further information

To simulate the function of the vehicle computer.

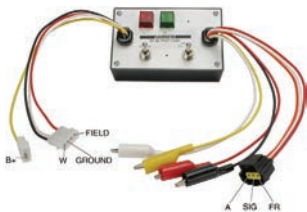

211126 Alternator Tester

Servicing: BSS & LIN

To simulate the function of the vehicle computer.



Voltage/DC: 12 V

TEST LEAD

210845 Test Lead

Servicing: Mitsubishi, Hitachi, Mazda - Visit www.hc-cargo.com for further information

For testing fo alternators w/ P-D terminals.

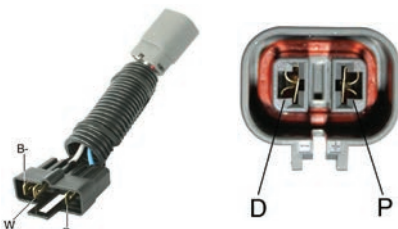

Plug type: 2

210846 Alternator Test Lead

For testing alternator w/ IG-S-L terminals.

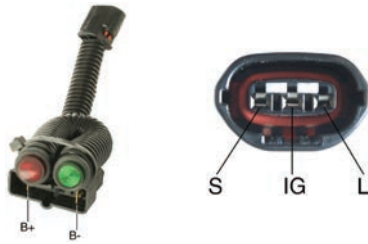

Plug type: 3

REGULATOR TESTER

210649 Regulator Tester

14 Volt and 28 Volt electronic and mechanical regulators can be tested independently of positive or negative grounded field. Tests lamp relays and can be used as digital voltmeter effective range 0-200 Volt. Adjustable field load of 0.5 Amp or 3.0 Amp. Instructions for use according to manual. Service voltage 230/240 V. AC. 50/60 Hz.



SLIDING GAUGE

211045 Vernier Gauge

- Jaw L. 40 mm.
- Reading 0.05 mm.



Length: 150 mm
Measuring range: 0-150

DIGITAL SLIDING GAUGE

211044 Digital Sliding Gauge

- Display w/ easy readable digits (H. 7.5 mm.)
- W/ "Absolute" electronics.
- Hardened jaws and tips.
- Jaw L. 40 mm.
- Reading 0.01 mm.
- Accuracy 0.03 mm.
- Low power use.



Length: 150 mm
Measuring range: 0-150

Batteries incl.: Yes
Digital: Yes

BATTERY CHARGERS

211035 Battery Charger



Voltage: 6-12
Amp: 1.5-3

Dim.: 150x90x135 mm
Weight: 1.550 kg

Auto stop: No
Approval: CE

211036 Battery Charger

 Voltage: 12-24
 Amp: 4-8

 Dim.: 210x125x180 mm
 Weight: 4.230 kg

 Auto stop: No
 Approval: CE

211073 Auto/Manual Charger

230 V. AC.

 Voltage: 12-24
 Amp: 8

 Dim.: 235x140x180 mm
 Weight: 4.950 kg

 Auto stop: Yes
 Approval: CE

TESTER
211039 Battery Charger/Tester

Ripple free chargers allow batteries to be charged w/o taking them out of the vehicle, by eliminating the alternating component and the voltage peaks and thus protecting the memories and electronic devices. Battery charger - tested for open lead-acid batteries. The charger - tester is protected against incorrect pole inversion. w/ the tester switched on you will be able to see the batteries actual condition and w/ the engine running you will be able to read the charge voltage of the alternator. The charger must not be connected to the same battery for several days, as there is a risk of boiling out the water.

 Voltage: 12-24
 Amp: 45/180

 Dim.: 290x170x240 mm
 Weight: 10.6 kg

Approval: CE

SPARE PARTS
211077 Test Connection

Plug type: RCA

BATTERY TESTER
211040 Battery Tester

Voltage: 12-24

 Dim.: 160x43x15 mm
 Weight: 0.124 kg

211041 Battery Tester

Easy to read digital display.



Voltage: 12/24

 Dim.: 180x30x18 mm
 Weight: 0.070 kg

211103 Battery Tester

Heavy duty copper plated clamps and nickel/chrome plated steel case.



Voltage: 6-12
Amp: 0-100

211124 Battery/Starting/Charging System Analyzer

Functions: 1. Check of battery condition. 2. Check of the cold cranking amps of the battery. 3 Check of the starting system. 4. Check of the charging system.



Voltage: 12
Amp: 25-200

Dim.: 119x68x19 mm
Weight: 0.18 kg

Approval: CE

CIRCUIT TESTER
210212 Circuit Tester

Bulb (18 V, 3 W): HC-CARGO 170643.



Voltage/DC 1:
6-24 V

Material: Chromed brass

210212Z Circuit Tester

Bulb (18 V, 3 W): HC-CARGO 170643.



Voltage/DC 1:
6-24 V

Material: Chromed brass

211042 Circuit Tester

Voltage/DC 1:
2.8-48 V

Dim.: 160x22x16 mm
Weight: 0.027 kg

211083 Power Probe II

w/ this adaptor you can use HC-CARGO 211058 for check of 7 pole and 7/13 multicon sockets. Rocker Switch HC-CARGO 211123.



Voltage/DC 1:
6-24 V

Length/test cable: 6 m

Test cable incl.: Yes

211094 Circuit Tester

Voltage: 6/12

211119 Circuit Tester

 Voltage/DC 1:
3-48 V

Warning lamp: Yes

211122 Circuit Tester

Computersafe wire 1.2 m w/ alligator clips.

 Voltage/DC 1:
6-12 V

Warning lamp: Yes

W/VOLTMETER
211097 Circuit Tester

Features: test light. Short circuit indicator. Continuity tester. Indicator for poor ground connection. Short circuit protection. Voltmeter. 6 m cable. Rocker Switch HC-CARGO 211123.

 Voltage/DC 1:
12-24 V

Colour: Red

SPARE PARTS
170643 Bulb Pinol

Servicing: HC-CARGO 210212

 Voltage: 18
Watt: 3

211123 Rocker Switch

Servicing: HC-CARGO 211083, 211097

 Type/terminal: Flat
Terminals: 3

ACCESSORIES
211117 Lead Set

Includes: 1-3-6 ft. stackable leads. Banana jack adapter. Large piercing probe. Small piercing probe. Alligator clip adapter. Case w/ organizer. Probe tip. Male/male adapter. Female/female adapter.

211118 Power Probe

Servicing: HC-CARGO 211097

Tip. 3".



SHORT CIRCUIT SEEKER
211091 Short Circuit Seeker

The ECT 2000 makes locating short and open circuits easier than ever before. Its advanced digital intelligence puts it above all others. The ECT 2000 detects and alerts you immediately whether a circuit is shorted or open. The receiver will also show you the direction to the short circuit.



A/C PARTS
VALVE CORE
211027 Valve Core Tool

211028 Valve Core Tool

BITS 1/4"
SLOTTED
25 MM

	HC-CARGO	Size	Length
	210855	6.5x1.2 mm	25 mm



39 MM











	HC-CARGO	Size	Length
	210708	5.5x1 mm	39 mm
	210709	8x1.2 mm	39 mm
	210710	8x1.6 mm	39 mm

50 MM



	HC-CARGO	Size	Length
	210749	6.5x1.2 mm	50 mm



PH				
25 MM				
	HC-CARGO	Type	Length	
 	210759	2	25 mm	
	210712	3	25 mm	
32 MM				
	HC-CARGO	Type	Length	
 	210713	4	32 mm	
	210744	4	32 mm	
50 MM				
	HC-CARGO	Type	Length	
 	210750	1	50 mm	
	210853	2	50 mm	
	210751	3	50 mm	
PZ				
25 MM				
	HC-CARGO	Type	Length	
 	210859	1	25 mm	
	210860	2	25 mm	
	210715	3	25 mm	
	210716	4	32 mm	
50 MM				
	HC-CARGO	Type	Length	
 	210740	2	50 mm	
	211115	2	50 mm	
TORX				
25 MM				
	HC-CARGO	Type	Length	
 	210718	T06	25 mm	
	210720	T08	25 mm	
	210722	T10	25 mm	
	210723	T15	25 mm	
	210724	T20	25 mm	
	210725	T25	25 mm	
	210726	T27	25 mm	
	210727	T30	25 mm	
	210728	T40	25 mm	
W/ BORING				
	HC-CARGO	Type	Size	Length
 	210729	T40		25 mm
	090310	T25	3.75 mm	25 mm
	090270	T40/T25	5.55/3.75 mm	
	090272	T45	6.6 mm	30 mm

HEX					
	HC-CARGO	Type	Length		
 	210752	3	50 mm		
	210753	4	50 mm		
	210754	5	50 mm		
BIT HOLDER					
W/RETAINING RING					
	HC-CARGO	Size	Length		
 	210755	57x6.3 mm	57 mm		
MAGNETIC					
	HC-CARGO	Size	Length		
 	210757	75x6.3 mm	75 mm		
BITS 5/16"					
SLOTTED					
	HC-CARGO	Size	length		
 	210741	12x2 mm	41 mm		
PH					
	HC-CARGO	Type	length		
 	210743	3	32 mm		
	210742	2	32 mm		
TORX					
	HC-CARGO	Type	length		
 	210745	T25	35 mm		
	210905	T40	35 mm		
	210747	T45	35 mm		
	210748	T50	35 mm		
FASTENING PARTS					
TAPPING SCREWS					
POZIDRIV					
FLAT HEAD W/GIMLET POINT					
	HC-CARGO	Dim.	Type	ISO norm	DIN norm
	192122	4.2x13 mm	8	7050	7982
	192123	4.8x16 mm	8	7050	7982

PAN HEAD

	HC-CARGO	Dim.	Type	ISO norm	DIN norm
	192006	2.9x9.5 mm	4	7049	7981C
	191753	2.9x16 mm	4	7049	7981C
	191798	2.9x19 mm	4	7049	7981C
	190360	3.5x9.5 mm	6	7049	7981C
	190361	3.5x16 mm	6	7049	7981C
	HC-CARGO	Dim.	Type	ISO norm	DIN norm
	190362	3.5x19 mm	6	7049	7981C
	190366	4.2x9.5 mm	8	7049	7981C
	192554	4.2x13 mm	8	7049	7981C
	190367	4.2x16 mm	8	7049	7981C
	190368	4.2x19 mm	8	7049	7981C
	190371	4.2x25 mm	8	7049	7981C
	190373	4.8x19 mm	10	7049	7981C
	192558	4.8x16 mm	10	7049	7981C

PAN HEAD W/GIMLET POINT

	HC-CARGO	Dim.	Type	ISO norm	DIN norm
	192114	3.5x13 mm	6	7049	7981
	190372	4.8x13 mm	10	7049	7981C

HEX

W/FLANGE

	HC-CARGO	Dim.	Type	DIN norm
	191988	6.3x19 mm	10 mm	7976C

HEX SCREWS

FULLY THREADED

	HC-CARGO	Dim.	Spanner size	ISO norm	DIN norm
	192447	M10-1.25 x 20 mm	17 mm	4017	933

EL-PLATED

	HC-CARGO	Dim.	Spanner size	ISO norm	DIN norm
	192365	UNC 1/4" x 3/4"	7/16"	4017	933
	192404	UNF 1/4" x 7/8"	7/16"	4017	933
	192778	UNC 5/16" x 3/4"	1/2"	4017	933
	192508	M4 x 14 mm	7 mm	4017	933
	191293	M4 x 25 mm	7 mm	4017	933
	192588	M5 x 6 mm	8 mm	4017	933
	192255	M5 x 12 mm	8 mm	4017	933
	191789	M5 x 14 mm	8 mm	4017	933
	190469	M5 x 16 mm	8 mm	4017	933
	190470	M5 x 20 mm	8 mm	4017	933
	190474	M5 x 40 mm	8 mm	4017	933
	191615	M5 x 50 mm	8 mm	4017	933
	192753	M6 x 10 mm		4017	933
	192418	M6 x 12 mm	10 mm	4017	933
	191644	M6 x 10 mm	10 mm	4017	933
	190477	M6 x 16 mm	10 mm	4017	933
	190478	M6 x 20 mm	10 mm	4017	933

	HC-CARGO	Dim.	Spanner size	ISO norm	DIN norm
	190479	M6 × 25 mm	10 mm	4017	933
	190480	M6 × 30 mm	10 mm	4017	933
	192063	M6 × 35 mm	10 mm	4017	933
	190482	M6 × 40 mm	10 mm	4017	933
	191536	M6 × 45 mm	10 mm	4017	933
	191854	M6 × 50 mm	10 mm	4017	933
	191645	M6 × 65 mm	10 mm	4017	933
	191804	M6 × 90 mm	10 mm	4017	933
	192256	M8 × 12 mm	13 mm	4017	933
	190492	M8 × 16 mm	13 mm	4017	933
	190493	M8 × 20 mm	13 mm	4017	933
	190494	M8 × 25 mm	13 mm	4017	933
	190495	M8 × 30 mm	13 mm	4017	933
	192251	M8 × 40 mm	13 mm	4017	933
	192752	M10 × 12 mm	17 mm	4017	933
	192511	M10 × 20 mm	17 mm	4017	933
	192247	M10 × 25 mm	17 mm	4017	933
	190506	M10 × 30 mm	17 mm	4017	933
	190508	M10 × 40 mm	17 mm	4017	933
	192248	M10 × 50 mm	17 mm	4017	933
192407	M10 × 50 mm	19 mm	4017	933	

EL-PLATED W/ESLOK

	HC-CARGO	Dim.	Spanner size	ISO norm	DIN norm
	191900	M5 × 16 mm	8 mm	4017	933

PARTLY THREADED

EL-PLATED

	HC-CARGO	Dim.	Spanner size	ISO norm	DIN norm
	191294	M6 × 80 mm	10 mm	4014	931
	192071	M8 × 100 mm	13 mm	4014	931
	190499	M8 × 50 mm	13 mm	4014	931
	190500	M8 × 60 mm	13 mm	4014	931
	192252	M8 × 70 mm	13 mm	4014	931
	192253	M8 × 80 mm	13 mm	4014	931
	190510	M10 × 50 mm	17 mm	4014	931
	190511	M10 × 60 mm	17 mm	4014	931
	192249	M10 × 70 mm	17 mm	4014	931
	192250	M10 × 80 mm	17 mm	4014	931

FLANGE

	HC-CARGO	Dim.	Spanner size	DIN norm
	191326	M4 × 10 mm	7 mm	6921
	B191326	M4 × 10 mm	7 mm	6921
	191327	M4 × 12 mm	7 mm	6921
	B191327	M4 × 12 mm	7 mm	6921
	B192519	M4 × 12 mm	7 mm	6921
	B191328	M4 × 14 mm	7 mm	6921
	191329	M4 × 16 mm	7 mm	6921
	B191329	M4 × 16 mm	7 mm	6921
	191330	M4 × 18 mm	7 mm	6921
	B191330	M4 × 18 mm	7 mm	6921
	B192520	M4 × 18 mm	7 mm	6921
	B191651	M4 × 20 mm	7 mm	6921
	191772	M5 × 25 mm	7 mm	6921
	191514	M4 × 28 mm	7 mm	6921

	HC-CARGO	Dim.	Spanner size	DIN norm
	B191514	M4 × 28 mm	7 mm	6921
	B192521	M4 × 28 mm	7 mm	6921
	191325	M4 × 8 mm	7 mm	6921
	B191325	M4 × 8 mm	7 mm	6921
	191545	M5 × 12 mm	8 mm	6921
	191546	M5 × 16 mm	8 mm	6921
	191867	M5 × 20 mm	8 mm	6921
	B191867	M5 × 20 mm	8 mm	6921
	B191792	M5 × 30 mm	8 mm	6921
	192416	M6 × 10 mm	10 mm	6921
	192706	M6 × 16 mm	10 mm	6921
	192425	M6 × 20 mm	10 mm	6921
	191987	M8 × 16 mm	13 mm	6921
	192532	M8 × 25 mm	13 mm	6921

W/ ESLOK

	HC-CARGO	Dim.	Spanner size	DIN norm
	192563	M4 × 8 mm	7 mm	6921
	192564	M4 × 10 mm	7 mm	6921
	192565	M4 × 14 mm	7 mm	6921
	192566	M4 × 16 mm	7 mm	6921
	192567	M5 × 12 mm	8 mm	6921
	192568	M5 × 16 mm	8 mm	6921

W/SPRING WASHER

	HC-CARGO	Dim.	Spanner size
	192536	M5 × 20 mm	7 mm
	192550	M5 × 20 mm	7 mm
	192551	M5 × 30 mm	7 mm

MACHINE SCREWS

POZIDRIV

FLAT HEAD

	HC-CARGO	Dim.	ISO norm	DIN norm
	191643	M4 × 18 mm	7046	965
	B191643	M4 × 18 mm	7046	965
	B192569	M4 × 18 mm	7046	965
	190561	M4 × 20 mm	7046	965
	191533	M4 × 22 mm	7046	965
	B191533	M4 × 22 mm	7046	965
	191322	M4 × 25 mm	7046	965
	191323	M4 × 30 mm	7046	965
	191678	M5 × 16 mm	7046	965
	191435	M5 × 35 mm	7046	965
	192822	M6 × 10 mm	7046	965
	191763	M6 × 20 mm	7046	965
	192347	M6 × 30 mm	7046	965

PAN HEAD

	HC-CARGO	Dim.	ISO norm	DIN norm
	191266	M3 × 5 mm	7045	7985
	190531	M3 × 10 mm	7045	7985
	192413	M3 × 16 mm	7045	7985
	192254	M3 × 20 mm	7045	7985
	191586	M4 × 6 mm	7045	7985
	191770	M4 × 8 mm	7045	7985

	HC-CARGO	Dim.	ISO norm	DIN norm
	190536	M4 × 10 mm	7045	7985
	190537	M4 × 12 mm	7045	7985
	191317	M4 × 14 mm	7045	7985
	190538	M4 × 16 mm	7045	7985
	191318	M4 × 18 mm	7045	7985
	190539	M4 × 20 mm	7045	7985
	192586	M4 × 22 mm	7045	7985
	190540	M4 × 25 mm	7045	7985
	190541	M4 × 30 mm	7045	7985
	190542	M4 × 40 mm	7045	7985
	190543	M4 × 50 mm	7045	7985
	191319	M5 × 6 mm	7045	7985
	191554	M5 × 8 mm	7045	7985
	190544	M5 × 10 mm	7045	7985
	192145	M5 × 12 mm	7045	7985
	192065	M5 × 16 mm	7045	7985
	192046	M5 × 20 mm	7045	7985
	192216	M5 × 25 mm	7045	7985
	190549	M5 × 30 mm	7045	7985
	192444	M5 × 35 mm	7045	7985
	190550	M5 × 40 mm	7045	7985
	191762	M5 × 45 mm	7045	7985
	190551	M5 × 50 mm	7045	7985
	191267	M5 × 60 mm	7045	7985
	192676	M6 × 8 mm	7045	7985
	190552	M6 × 10 mm	7045	7985
	190556	M6 × 25 mm	7045	7985
	190558	M6 × 40 mm	7045	7985
	191624	M6 × 45 mm	7045	7985
	192704	M6 × 50 mm	7045	7985
PAN HEAD W/ESLOK				
	HC-CARGO	Dim.	ISO norm	DIN norm
	192569	M4 × 18 mm	7046	965
	192571	M4 × 22 mm	7046	965
	192572	M4 × 25 mm	7046	965
PAN HEAD W/WASHER				
	HC-CARGO	Dim.		
	191478	M4 × 25 mm		
	B191478	M4 × 25 mm		
	B192572	M4 × 25 mm		
THRU BOLTS				
	HC-CARGO	Dim.	Thread length	
	B230731	M5 × 65 mm	22.15 mm	
	191899	M5 × 90 mm	35 mm	
	191528	M5 × 95 mm	30 mm	
	191582	M5 × 100 mm	60 mm	
	B191582	M5 × 100 mm	60 mm	
	191873	M5 × 120 mm	60 mm	
	191584	M5 × 125 mm	60 mm	
	191585	M5 × 135 mm	60 mm	
	191530	M6 × 75 mm	25 mm	
	191531	M6 × 85 mm	25 mm	
	191558	M6 × 95 mm	30 mm	

TORX

FLAT HEAD

192754 Hex Screw



Length: 12 mm
Thread: M8

Head type: Flat head
Screw type: Torx
ISO norm: 14581

SLOTTED

CHEESE HEAD



	HC-CARGO	Dim.	ISO norm	DIN norm
	192372	M4 × 6 mm	1207	84A
	191320	M5 × 8 mm	1207	84A
	190545	M5 × 12 mm	1207	84A
	191505	M5 × 14 mm	1207	84A
	190546	M5 × 16 mm	1207	84A
	190547	M5 × 20 mm	1207	84A
	191557	M5 × 25 mm	1207	84A
	192060	M5 × 60 mm	2009	963
	191321	M6 × 12 mm	1207	84A
	190555	M6 × 20 mm	1207	84A
	192515	M6 × 22 mm	1207	84A

CHEESE HEAD, PHILLIPS



	HC-CARGO	Dim.	ISO norm
	192984	M4 × 30 mm	7048
	192364	M4 × 35 mm	7048

FLANGE



	HC-CARGO	Dim.
	191658	M4 × 6 mm
	191677	M4 × 8 mm
	191659	M5 × 6 mm
	191660	M5 × 8 mm
	191661	M5 × 10 mm
	191790	M5 × 12 mm

SOCKET HEAD CAPS

FULLY THREADED



	HC-CARGO	Dim.	Quality	ISO norm	DIN norm
	192671	M4 × 8 mm	12.9	4762	912
	192672	M4 × 10 mm	12.9	4762	912
	191486	M5 × 14 mm	12.9	4762	912
	192414	M5 × 16 mm	10.9	7380	
	191613	M5 × 20 mm	12.9	4762	912
	192440	M5 × 25 mm	12.9	4762	912
	192405	M5 × 45 mm	12.9	4762	912
	192591	M6 × 16 mm	12.9	4762	912
	191614	M6 × 20 mm	12.9	4762	912
	192592	M6 × 25 mm	12.9	4762	912
	192594	M6 × 50 mm	12.9	4762	912
	192790	M7 × 50 mm	12.9	4762	912
	192491	M8 × 16 mm	12.9	4762	912

PARTLY THREADED



	HC-CARGO	Dim.	Thread length	Quality
	192073	M5 × 55 mm	22 mm	12.9
	192441	M5 × 60 mm	22 mm	12.9
	191539	M5 × 75 mm	25 mm	12.9

THREAD FORMING					
PAN HEAD					
	HC-CARGO	Dim.	Torx	DIN norm	
	192727	M4 × 16 mm	T20	7500	
	192725	M4 × 10 mm	T20	7500	
SOCKET SET SCREWS					
	HC-CARGO	Dim.	ISO norm	DIN norm	
	191432	M5 × 25 mm	4029	916	
NUTS					
HEX					
STEEL, DIN 934					
	HC-CARGO	Dim.	Spanner size	DIN norm	
	190520	M3	5.5 mm	934	
	190521	M4	7 mm	934	
	190779	M5	8 mm	934	
	190780	M6	10 mm	934	
	190781	M7	11 mm	934	
	190782	M8	13 mm	934	
	191898	M10	14 mm	934	
	190783	M10	17 mm	934	
	191477	M12	19 mm	934	
	191297	M12-1.25	19 mm	934	
	191296	M12-1.5	19 mm	934	
	191298	M14-1.5	22 mm	934	
	191299	M16-1.5	24 mm	934	
	191754	M17-1.5	27 mm	934	
192127	UNC 1/4"	7/16"	934		
STEEL, DIN 439B					
	HC-CARGO	Dim.	Spanner size	ISO norm	DIN norm
	191302	M5	8 mm	4035	439B
	191303	M6	10 mm	4035	439B
	191304	M8	13 mm	4035	439B
	191305	M10	17 mm	4035	439B
	191439	M12	19 mm	4035	439B
	192228	M14-1.5	22 mm	4035	439B
	191657	M16-1.5	24 mm	4035	439B
	SELF-LOCKING W/NYLON				
	HC-CARGO	Dim.	Spanner size	DIN norm	
	192750	M4	7 mm	985	
	190524	M5	8 mm	985-6	
	190525	M6	10 mm	985-6	
	190527	M8	13 mm	985-6	
	190528	M10	17 mm	985-6	
	192143	M12	19 mm	985-6	
	SELF-LOCKING W/FLANGE				
	HC-CARGO	Dim.	Spanner size		
	191306	M4	7 mm		
	B191306	M4	7 mm		
	191307	M5-0.8	8 mm		
	B191307	M5	8 mm		
	191308	M6	10 mm		
	B191308	M6	10 mm		
	191513	M8	13 mm		
	B191513	M8	13 mm		

COUPLING

	HC-CARGO	Dim.	Spanner size	Length
	192417	M6	10 mm	18 mm
	192072	M8	13 mm	24 mm

THREADED SPACERS

191580 Threaded Spacer

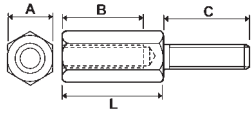

A: 7 mm
 B: M4x9 mm
 C: M4x8 mm
 L: 12 mm
 Coating: Electro galvanized

Thread type: Inner & Outer
 Material: Steel

191625 Threaded Spacer

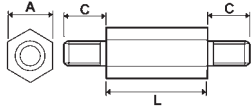

A: 8 mm
 C: M5x10 mm
 L: 40 mm
 Coating: Electro galvanized

Thread type: External
 Material: Steel

191626 Threaded Spacer

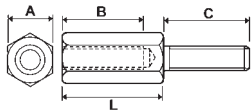

A: 8 mm
 B: M5x9 mm
 C: M4x10 mm
 L: 12 mm
 Coating: Electro galvanized

Thread type: Inner & Outer
 Material: Steel

FLAME ARRESTER

COPPER

	HC-CARGO	ID	OD	Thickness
	080696	6.2 mm	9.8 mm	1 mm
	080456	6.8 mm	14.5 mm	1 mm
	080689	7 mm	11 mm	1.5 mm
	080403	7 mm	15 mm	6.7 mm
	080439	7.2 mm	20 mm	1.5 mm
	080412	7.3 mm	14 mm	4 mm
	080410	7.3 mm	14 mm	4.8 mm
	080691	7.35 mm	14.95 mm	1.5 mm
	080739	7.4 mm	13.8 mm	1.55 mm
	081067	7.4 mm	14.95 mm	1.76 mm
	081068	7.4 mm	14.95 mm	1.96 mm
	081172	7.4 mm	15 mm	2.55 mm
	080425	7.5 mm	15 mm	2 mm
	081209	7.5 mm	15 mm	2 mm
	081114	7.5 mm	15 mm	3 mm
	081113	7.6 mm	13 mm	2.5 mm
	081212	7.6 mm	17 mm	3.5 mm
	080397	7.7 mm	20 mm	2.7 mm
	081115	7.75/7.15 mm	15 mm	1.5 mm
	081173	7.75/7 mm	15.1 mm	2 mm
	080417	7.8 mm	10.8 mm	1.5 mm
	081055	7.8 mm	14.95 mm	1.56 mm
	080426	8 mm	15 mm	1 mm
	080427	8 mm	15 mm	2 mm
	080697	8.1 mm	11.1 mm	0.9 mm

	HC-CARGO	ID	OD	Thickness
	080803	8.3 mm	12.9 mm	2.5 mm
	081088	8.4 mm	14.95 mm	0.8/1.65 mm
	080400	9 mm	19 mm	7.5 mm
	080693	9.3 mm	15 mm	1.6 mm
	080451	9.3 mm	22 mm	0.8 mm
	081183	9.5 mm	15.6 mm	1.5 mm
	080454	9.5 mm	22.5 mm	0.4 mm
	080692	9.75 mm	18.7 mm	2 mm
	080428	10 mm	15 mm	2 mm
	080411	10 mm	16 mm	4 mm
	080431	10 mm	16.3 mm	1.5 mm
	080432	10 mm	18 mm	1 mm
	080433	10 mm	18 mm	1.5 mm
	080436	10 mm	19 mm	2 mm
	080438	10 mm	19 mm	0.3 mm
	080440	10 mm	20 mm	0.5 mm
	080441	10 mm	20 mm	1 mm
	080442	10 mm	20 mm	1.5 mm
	080443	10 mm	20 mm	2 mm
	080296	10 mm	21 mm	1 mm
	080452	10 mm	22 mm	0.7 mm
	080453	10 mm	22 mm	1 mm
	080782	10.5 mm	17.85 mm	1 mm
	080401	10.7 mm	18 mm	4.4 mm
	080402	11 mm	17.5 mm	5.4 mm
	080434	12 mm	18 mm	2 mm
	080705	12.3 mm	17.9 mm	1.4 mm
	080444	14 mm	20 mm	1.8 mm
	080447	14 mm	20 mm	2.5 mm
	080387	14.3 mm	18.9 mm	2 mm
	080446	14.3 mm	20 mm	2 mm
	080734	14.4 mm	20.8 mm	1.4 mm
	080961	14.4 mm	21.5 mm	2.1 mm
	080430	14.5 mm	21 mm	1.5 mm
	080688	14.5 mm	22.5 mm	1.4 mm
	080435	15 mm	18 mm	0.5 mm
	080448	15.3 mm	20 mm	2 mm
	080802	15.6 mm	21.2 mm	2.25 mm
	080763	15.7 mm	20.5 mm	2 mm
	080761	17 mm	20 mm	1.5 mm
080777	17.1 mm	21.2 mm	1.7 mm	
080450	17.5 mm	21.5 mm	1.5 mm	

FIBER

	HC-CARGO	ID	OD	Thickness
	080031	5 mm	9.5 mm	2 mm
	080032	6 mm	10 mm	1.5 mm
	080033	8 mm	15 mm	1.5 mm
	080034	10 mm	16 mm	1.5 mm
	080035	12 mm	18 mm	1.5 mm
	134699	12.15 mm	23.8 mm	1 mm
	080036	14 mm	20 mm	1.5 mm
	134768	15 mm	22 mm	2 mm

STEEL

	HC-CARGO	ID	OD	Thickness
	080989	4 mm	9.5/10.8 mm	1.3 mm
	080404	4.9 mm	11.5 mm	1.25 mm
	081146	5.1 mm	13.5 mm	1.2 mm
	080408	5.2 mm	13.9 mm	1.1 mm
	080039	5.3 mm	23.6 mm	3.5 mm

	HC-CARGO	ID	OD	Thickness
	080231	5.4 mm	21 mm	12.9 mm
	081148	5.5 mm	13.8 mm	1.5 mm
	080390	5.5 mm	20.15 mm	3.5 mm
	080395	5.5 mm	21 mm	9.55 mm
	080386	5.55 mm	23.75 mm	3.45 mm
	080407	6.4 mm	13.9 mm	1.7 mm
	080388	7.3 mm	13.6 mm	1.3 mm
	080398	7.3 mm	13.8 mm	1.4 mm
	080413	7.3 mm	21.6 mm	14.5 mm
	080394	7.35 mm	21.5 mm	14.55 mm
	080409	7.35 mm	21.5 mm	13.4 mm
	080392	7.5 mm	20.2 mm	2.45 mm
	080423	7.6 mm	20.3 mm	2.5 mm
	080736	7.9 mm	20 mm	2.85 mm
	080385	8.25 mm	24.6 mm	3.8 mm
	080449	9.3 mm	20.5 mm	2.6 mm
	080416	10 mm	14 mm	1.6 mm
	080732	10.1 mm	20 mm	2.6 mm

ALUMINIUM

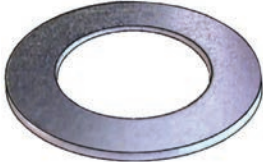
	HC-CARGO	ID	OD	Thickness
	080733	8.2 mm	11.1 mm	1 mm
	080437	10 mm	19 mm	0.3 mm

BRASS

	HC-CARGO	ID	OD	Thickness
	080236	7.1 mm	13.4 mm	1.1 mm
	080405	7.1 mm	13.8 mm	1.3 mm
	080764	7.7 mm	17 mm	2.6 mm
	080677	7 mm	21.5 mm	3.95 mm
	080406	8.5 mm	14.3 mm	1.1 mm
	080419	8.8 mm	14 mm	1.3 mm
	080424	10.8 mm	17.5 mm	1.7 mm
	080418	12.6 mm	18 mm	2.5 mm
	080415	15.5 mm	20.5 mm	2.8 mm
	080414	15 mm	20 mm	2.8 mm

WASHERS

FLAT STEEL

	HC-CARGO	ID	OD	Thickness	Material
	190587	3.5 mm	9.5 mm	0.8 mm	Steel
	190588	4.3 mm	9.5 mm	0.8 mm	Steel
	191502	5.3 mm	9 mm	1 mm	Steel
	191506	5.3 mm	10 mm	1 mm	Steel
	192667	5.3 mm	12 mm	1 mm	Steel
	190589	5.5 mm	12.7 mm	1 mm	Steel
	192695	6.4 mm	25 mm	1.8 mm	Steel
	191290	6.5 mm	13 mm	1 mm	Steel
	190590	6.8 mm	16 mm	1.1 mm	Steel
	190591	7.4 mm	14 mm	1.6 mm	Steel
	190592	8.4 mm	19 mm	1.25 mm	Steel
	192696	8.4 mm	30 mm	2 mm	Steel
	191337	10 mm	16 mm	0.5 mm	Steel
	192362	10 mm	16 mm	1 mm	Steel

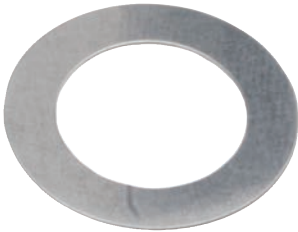
	HC-CARGO	ID	OD	Thickness	Material
	193025	10 mm	16 mm	0.25 mm	Steel
	190593	10 mm	21 mm	1.25 mm	Steel
	192124	11 mm	17 mm	1 mm	Steel
	191503	11.5 mm	19 mm	1.5 mm	Steel
	192363	12 mm	18 mm	0.3 mm	Steel
	192062	12 mm	18 mm	0.5 mm	Steel
	191491	12 mm	18 mm	1 mm	Steel
	192245	12 mm	22 mm	0.5 mm	Steel
	191457	13 mm	19 mm	0.5 mm	Steel
	190594	13 mm	24 mm	2.5 mm	Steel
	192585	14 mm	26 mm	0.3 mm	Steel
	191335	14 mm	26 mm	0.5 mm	Steel
	191868	15 mm	22 mm	0.1 mm	Steel
	191548	15 mm	22 mm	0.5 mm	Steel
	191538	15 mm	22 mm	1 mm	Steel
	192438	15 mm	24 mm	0.5 mm	Steel
	191487	16 mm	28 mm	0.5 mm	Steel
	192663	17 mm	24 mm	1 mm	Steel
	191560	17 mm	24 mm	1.5 mm	Steel
	191901	17 mm	24 mm	0.5 mm	Steel
	192821	18 mm	31.9 mm	0.5 mm	Metal
	191815	20 mm	28 mm	0.5 mm	Steel
	192718	20 mm	32 mm	0.5 mm	Steel
	191504	28 mm	40 mm	0.3 mm	Steel

SEALING RINGS

	HC-CARGO	ID	OD	Thickness	Material
	190823	6 mm	10 mm	1 mm	Copper
	080004	6 mm	12 mm	1 mm	Copper
	190824	6.3 mm	12 mm	1 mm	Copper
	192367	8 mm	12 mm	1 mm	Aluminium
	190828	8 mm	14 mm	1 mm	Copper
	190826	8.2 mm	12 mm	1 mm	Copper
	190806	10.3 mm	16 mm	1 mm	Copper
	190807	12 mm	16 mm	1.5 mm	Aluminium
	190808	12 mm	16 mm	1.5 mm	Copper
	190809	12 mm	18 mm	1.5 mm	Copper
	191358	12 mm	24 mm	1 mm	Copper
	190810	13 mm	18 mm	1.5 mm	Copper
	190811	14 mm	18 mm	1.5 mm	Aluminium
	190812	14 mm	18 mm	1.5 mm	Copper
	190813	14 mm	20 mm	1.5 mm	Aluminium
	190815	14 mm	20 mm	1.5 mm	Copper
	190816	16 mm	20 mm	1 mm	Copper
	190817	16 mm	20 mm	1.5 mm	Copper
	190818	16 mm	22 mm	1.5 mm	Copper
	191489	16 mm	24 mm	1.5 mm	Copper
	190819	18 mm	22 mm	1.5 mm	Copper
	190820	18 mm	24 mm	1.5 mm	Copper
	191490	18 mm	26 mm	1.5 mm	Copper
	190821	20 mm	26 mm	1.5 mm	Copper
	190822	22 mm	27 mm	1.5 mm	Copper

INSULATORS

FIBERS

	HC-CARGO	ID	OD	Thickness	Material
	191346	4 mm	13 mm	1 mm	Red fiber
	191341	5 mm	10 mm	1 mm	Red fiber
	191351	5 mm	12 mm	1 mm	Red fiber
	191352	5 mm	16 mm	1 mm	Red fiber
	191344	6 mm	10 mm	1 mm	Red fiber

	HC-CARGO	ID	OD	Thickness	Material
	191350	6 mm	18 mm	1.5 mm	Red fiber
	191442	7.5 mm	14 mm	3 mm	Red fiber
	191345	8 mm	20 mm	2 mm	Red fiber
	191353	8 mm	12 mm	0.5 mm	Red fiber
	191349	10 mm	16 mm	1 mm	Red fiber
	191356	10 mm	29 mm	1 mm	Red fiber
	191434	10 mm	14 mm	1 mm	Red fiber
	191648	10 mm	25 mm	2 mm	Red fiber
	191348	12.2 mm	22 mm	1 mm	Red fiber
	191339	12 mm	19 mm	1 mm	Red fiber
	191347	13 mm	23 mm	1.5 mm	Red fiber
	191646	13 mm	29 mm	2 mm	Red fiber
	191532	14 mm	34 mm	2 mm	Red fiber
	191430	14.5 mm	29 mm	1 mm	Red fiber
	191342	15 mm	29 mm	3 mm	Red fiber
	191869	15 mm	24 mm	0.5 mm	Red fiber
	191355	20.5 mm	35 mm	1.5 mm	Red fiber
	191357	23.8 mm	36 mm	2.5 mm	Red fiber
	191340	29 mm	33 mm	1.5 mm	Red fiber
	191354	45 mm	51 mm	1 mm	Red fiber

FENDERS

	HC-CARGO	ID	OD	Thickness	ISO norm	DIN norm
	190606	10.5 mm	30 mm	2.5 mm	7093	9021A
	192697	10.5 mm	35 mm	2.5 mm		
	191813	3.2 mm	9 mm	0.8 mm	7093	9021A
	191289	4.3 mm	12 mm	1 mm	7093	9021A
	190603	5.3 mm	15 mm	1.2 mm	7093	9021A
	192694	5.3 mm	20 mm	1.5 mm		
	190604	6.4 mm	18 mm	1.6 mm	7093	9021A
	190605	8.4 mm	24 mm	2 mm	7093	9021A
	191291	8.4 mm	15 mm	1.6 mm	7092	433

SPRING LOCK

	HC-CARGO	ID	Material
	192348	1/2" mm	Steel spring
	192128	1/4" mm	Steel spring



CURVED

	HC-CARGO	ID	OD	Thickness	Material	DIN norm
	190583	10.2 mm	18.1 mm	1.8 mm	Steel spring	128A
	190584	12.2 mm	18.1 mm	2.1 mm	Steel spring	128A
	191287	14.2 mm	24.1 mm	2.4 mm	Steel spring	137A
	191288	16.2 mm	27.4 mm	2.8 mm	Steel spring	137A
	190577	3.1 mm	6.2 mm	0.7 mm	Steel spring	128A
	190578	4.11 mm	7.2 mm	0.85 mm	Steel spring	128A
	192678	5.3 mm	10 mm	0.5 mm	Steel spring	137A
	190579	5.4 mm	9.2 mm	1 mm	Steel spring	128A
	190580	6.1 mm	11.8 mm	1.3 mm	Steel spring	128A
	190581	7.1 mm	12.8 mm	1.3 mm	Steel spring	128A
	190582	8.1 mm	14.8 mm	1.6 mm	Steel spring	128A
	192679	8.4 mm	15 mm	0.5 mm	Steel spring	137A

STEEL

W/CHAMFER

	HC-CARGO	ID	OD	Thickness	ISO norm	DIN norm	Material
	191578	5.3 mm	10 mm	1 mm	7090	125B	Steel
	190598	6.4 mm	12 mm	1.6 mm	7090	125B	Steel
	190599	8.4 mm	16 mm	1.6 mm	7090	125B	Steel
	191579	10.5 mm	20 mm	2 mm	7090	125B	Steel

W/KEY SLOT					
	HC-CARGO	ID	OD	Thickness	Material
	191265	17 mm	34 mm	2 mm	Steel
LOCK					
EXTERNAL SERRATED					
	HC-CARGO	ID	DIN norm	Material	
	190616	M4	6798A	Steel, Electro galvanised	
	190612	M5	6798A	Steel, Electro galvanised	
	190613	M6	6798A	Steel, Electro galvanised	
	190614	M8	6798A	Steel, Electro galvanised	
INTERNAL SERRATED					
	HC-CARGO	ID	DIN norm	Material	
	190608	M6	6798J	Steel, Electro galvanised	
	190609	M8	6798J	Steel, Electro galvanised	
	190610	M10	6798J	Steel, Electro galvanised	
WAVED TYPE					
	HC-CARGO	ID	OD	Thickness	
	191903	11.4 mm	18.8 mm	0.3 mm	
	191913	16.3 mm	24 mm	1.5 mm	
	191336	17 mm	30 mm	1.6 mm	
COTTER PINS					
	HC-CARGO	OD	Length	DIN norm	Material
	191575	1.6 mm	16 mm	94	Steel
	190632	2 mm	32 mm	94	Steel
	190633	2 mm	40 mm	94	Steel
	190634	2.5 mm	25 mm	94	Steel
	190638	3.2 mm	32 mm	94	Steel
	191576	3.2 mm	25 mm	94	Steel
	191577	4 mm	36 mm	94	Steel
	191587	4 mm	25 mm	94	Steel
BUSHINGS					
	HC-CARGO	Length			
	080161	20 mm		Bushing for cover	
	080162	25 mm		Bushing for cover	
	080165	30.5 mm		Bushing for cover	
	080232	33.5 mm		Bushing for cover	
	080164	35 mm		Bushing for cover	
	080163	40.5 mm		Bushing for cover	
THREADED					
192578 Thread Insert					
For glow plugs. Machine tap: HC-CARGO 211063.					
		Total length: 10 mm Thread size/internal: M10-1 Thread size/external: M12-1			

RIVETS

	HC-CARGO	OD	Length	DIN norm	Material
	191441	3 mm	6 mm	660	Steel
	191309	3 mm	10 mm	660	Steel
	191284	4 mm	6 mm	660	Copper
	191285	4 mm	12 mm	660	Aluminium
	191311	4 mm	12 mm	660	Steel
	191312	4 mm	14 mm	660	Steel
	192048	5 mm	20 mm	674	Aluminium

BLIND

	HC-CARGO	OD	Length	Grip range	DIN norm	Material
	190660	3.2 mm	10 mm	5-7	7337A	Steel/Steel
	191649	4 mm	10 mm	4.5-6.5	7337A	Stainless steel
	191458	4 mm	10 mm	5-6.5	7337A	Alu/Steel
	192689	4 mm	10.3 mm	5-6.5	7337A	Alu/Alu
	191459	4 mm	16 mm	8.5-12	7337A	Alu/Alu
	191440	4 mm	18 mm	11.5-14.5	7337A	Alu/Steel

TUBULAR

	HC-CARGO	OD	OD	Length	Material
	191552	6 mm	5.2 mm	25 mm	Brass

STORAGE

SMALL PART STORAGE SYSTEMS

200588 Storage Box

Strong fibre stiffened cardboard, supplied w/ 2 labels, quickly assembled w/o staples or tape. Economical, strong and practical. Dim.: 300x120x120 mm.



200589 Storage Box

Strong fibre stiffened cardboard, supplied w/ 2 labels, quickly assembled w/o staples or tape. Economical, strong and practical. Dim.: 300x195x120 mm.



METAL ASSORTMENT BOXES

200633 Assortment Box

w/ plastic insertion. 20 rooms. Dim.: 333x230x55 mm.





Assortments

Edition 2014/2015



ASSORTMENTS
BOXES
200663 Assortment Box
Can be divided using inserts.

 Length: 265 m
 Thickness: 57 mm
 Width: 340 mm

Material: Polypropylene

200875 Carry Lite Assortment Box

 Length: 413 m
 Thickness: 57 mm
 Width: 330 mm

 Colour: Anthracite
 Material: Polypropylene

200876 Carry Lite Assortment Box
80-01.

 Length: 413 m
 Thickness: 79 mm
 Width: 330 mm

 Colour: Anthracite
 Material: Polypropylene

200877 Carry Lite Assortment Box

 Length: 413 m
 Thickness: 147 mm
 Width: 330 mm

 Colour: Anthracite
 Material: Polypropylene

200878 Foam

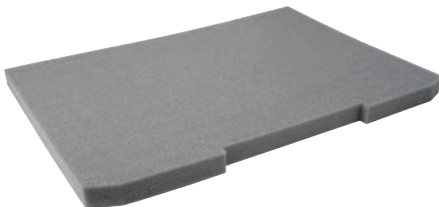
 Servicing: Carry Lite - Visit www.HC-CARGO.com for further information

 Length: 389 m
 Thickness: 22 mm
 Width: 284 mm

 Colour: Anthracite
 Material: Plastic

200879 Rail Set
For CL-box.

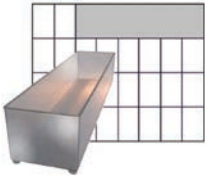

INSERTS			
200664 Insert			
<i>Unbreakable.</i>			
		Length: 40.00 m Thickness: 45.00 mm Width: 55.00 mm	Material: Polypropylene
200665 Insert			
<i>Unbreakable.</i>			
		Length: 110.00 m Thickness: 45.00 mm Width: 40.00 mm	Material: Polypropylene
200666 Insert			
<i>Unbreakable.</i>			
		Length: 165.00 m Thickness: 45.00 mm Width: 40.00 mm	Material: Polypropylene
200667 Insert			
<i>Unbreakable.</i>			
		Length: 220.00 m Thickness: 45.00 mm Width: 40.00 mm	Material: Polypropylene
200668 Insert			
<i>Unbreakable.</i>			
		Length: 80.00 m Thickness: 45.00 mm Width: 55.00 mm	Material: Polypropylene
200669 Insert			
<i>Unbreakable.</i>			
		Length: 160.00 m Thickness: 45.00 mm Width: 55.00 mm	Material: Polypropylene

200670 Insert

Unbreakable.

 Length: 240.00 m
 Thickness: 45.00 mm
 Width: 55.00 mm

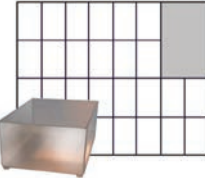
Material: Polypropylene

200671 Insert

Unbreakable.

 Length: 110.00 m
 Thickness: 45.00 mm
 Width: 80.00 mm

Material: Polypropylene

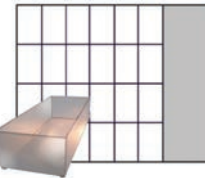
200672 Insert

Unbreakable.

 Length: 220.00 m
 Thickness: 45.00 mm
 Width: 80.00 mm

Material: Polypropylene

200673 Insert

Unbreakable.

 Length: 160.00 m
 Thickness: 45.00 mm
 Width: 110.00 mm

Material: Polypropylene

DISPLAY
200676 Display for 4 Assortments

Frame for 4 Profi service cases.

 Length: 200.00 m
 Thickness: 330.00 mm
 Width: 360.00 mm

200693 Assortment Display

Frame for 4 Profi service cases. Can be assembled horizontally or vertically.

 Length: 265.00 m
 Thickness: 313.00 mm
 Width: 373.00 mm

HSS DRILLS
210574 Drill Assortment

Contains 178 drills from 1-10.5 mm.

ATO Blade Fuses

804008

Type	Amp	Qty.
191465 ... Mini blade fuse	2	10
191466 ... Mini blade fuse	3	10
191467 ... Mini blade fuse	4	10
191468 ... Mini blade fuse	5	10
191469 ... Mini blade fuse	7.5	10
191470 ... Mini blade fuse	10	10
191471 ... Mini blade fuse	15	10
191472 ... Mini blade fuse	20	10
191473 ... Mini blade fuse	25	10
191474 ... Mini blade fuse	30	10
191475 ... ATO blade fuse	1	25
191476 ... ATO blade fuse	2	25
190053 ... ATO blade fuse	3	50
190054 ... ATO blade fuse	4	50

Type	Amp	Qty.
190055 ... ATO blade fuse	5	50
190056 ... ATO blade fuse	7.5	50
190057 ... ATO blade fuse	10	50
190058 ... ATO blade fuse	15	50
190059 ... ATO blade fuse	20	50
190060 ... ATO blade fuse	25	50
190061 ... ATO blade fuse	30	50
191664 ... ATO blade fuse	40	50

Connectors & Insulators

804012

	Qty.
191007 . Insulator	50
191126 . Insulator	25
191127 . Insulator	50
191227 . Insulator	10
191226 . Insulator	10
190260 . Multiple connector 2-pole	10
190261 . Multiple connector 2-pole	10
190843 . Multiple connector 2-pole	10
190272 . Multiple connector 2-pole	10
191158 . Multiple connector 2-pole	10
191159 . Multiple connector 2-pole	10
190262 . Multiple connector 3-pole	10
190263 . Multiple connector 3-pole	10
191224 . Multiple connector 3-pole	10

	Qty.
191225 . Multiple connector 3-pole	10
190264 . Multiple connector 4-pole	8
190265 . Multiple connector 4-pole	8
190266 . Multiple connector 6-pole	4
190267 . Multiple connector 6-pole	4

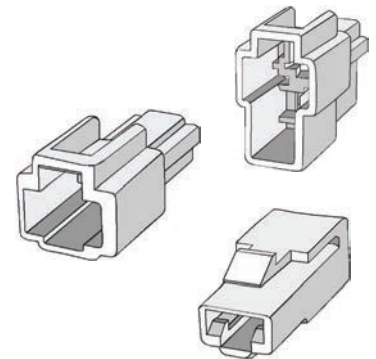
Insulated Terminals

804014

	Qty.
190049 Terminal 2.8 mm. red	100
190045 Terminal 4.7 mm. red	100
190022 Terminal 6.3 mm. red	100
190020 Terminal 6.3 mm. blue	100
190024 Terminal 6.3 mm. yellow	50
190041 Terminal 8.0 mm. blue	50
190048 Terminal 9.5 mm. yellow	50
190985 Terminal 6.3 mm. red	100
190046 Terminal 6.3 mm. blue	100
190025 Terminal 6.3 mm. red	50
190026 Terminal 6.3 mm. blue	50
190016 Terminal 6.3 mm. blue	100
190019 Terminal 6.3 mm. red	100
190021 Terminal, O.D. 4 mm. red	100

	Qty.
190023 Terminal, O.D. 4 mm. blue	75
190017 Terminal, I.D. 5 mm. red	100
191009 Shrinkable full insulated, red	25
191010 Shrinkable full insulated, blue	25
190028 Butt connector, red	100
190001 Butt connector, blue	100
190018 Terminal, blue	50
191011 Shrinkable full insul., yellow	20

Nozzle Holder Parts

806015

	mm	Qty.
190038 Terminal	3 ... red	100
190257 Terminal	3 ... blue	100
190027 Terminal	4 ... red	100
190973 Terminal	4 ... red	100
190029 Terminal	4 ... blue	100
190032 Terminal	4 ... blue	100
191067 Terminal	4 ... blue	100
190031 Terminal	5 ... red	100
190037 Terminal	5 ... blue	100
190033 Terminal	5 ... yellow	50
190015 Terminal	6 ... red	100
190034 Terminal	6 ... blue	100
190035 Terminal	6 ... yellow	50
190039 Terminal	8 ... blue	50

	mm	Qty.
190255 Terminal	8 ... yellow	50
190042 Terminal	10 ... yellow	50
190974 Terminal	red	100
190952 Terminal	blue	100
190953 Terminal	yellow	50



ABS Connectors & Tools
804017

	Qty.
191168 . Tube for 1.5 mm ²	10
192180 . Tube for 1.5 mm ²	10
192181 . Tube for 1.5 mm ²	10
191196 . Tube for 4.0 mm ²	10
191197 . Tube for 4.0 mm ²	10
191169 . Tube for 6.0 mm ²	10
191171 . Pin for 1.5 mm ²	10
191172 . Pin for 6.0 mm ²	10
180245 . Sealing disc kit set	2
210643 . Ejection tool 6.5 mm ²	1
210644 . Dismounting bush 6.5 mm ²	1
210645 . Mounting bush 6.5 mm ²	1
210696 . Crimping tool	1

Sealing Rings I
804020

ID	OD	Th. mm	Qty.
190823	6	10	1 Copper
190824	6	12	1 Copper
190826	8	12	1 Copper
190828	8	14	1 Copper
080009	10	14	1 Copper
190806	10	16	1 Copper
190807	12	16	1.5 Alu.
190808	12	16	1.5 Copper
190809	12	18	1.5 Copper
191358	12	24	1 Copper
190810	13	18	1.5 Copper
190811	14	18	1.5 Alu.
190812	14	18	1.5 Copper
190813	14	20	1.5 Alu.

ID	OD	Th. mm	Qty.
190815	14	20	1.5 Copper
190816	16	20	1 Copper
190817	16	20	1.5 Copper
190818	16	22	1.5 Copper
191489	16	24	1.5 Copper
190819	18	22	1.5 Copper
190820	18	24	1.5 Copper
191490	18	26	1.5 Copper
190821	20	26	1.5 Copper
190822	22	27	1.5 Copper



Rubber Clamps (Rubber profile 12.7 mm. - Fixing hole 6.8 mm.)
804021

Pipe OD	Type	Qty.
190899	6.4 mm	6
190900	7.9 mm	8
190901	9.5 mm	10
190902	11.1 mm	11
190903	12.7 mm	13
190904	14.3 mm	14
190905	15.9 mm	16
190906	17.5 mm	18
190907	19.0 mm	19
190908	22.2 mm	22
190909	25.4 mm	25
191417	28.6 mm	29

Rubber Grommets
804022

B mm	C mm	D mm	Amp	Qty.
190964	5.5	8	1.6	20
190120	6.4	9.5	1.6	20
190965	8	9.5	1.6	20
190966	8	11	1.6	20
190967	8	12.5	1.6	20
190122	9.5	12.5	1.6	20
190968	11	14.2	1.6	20
190969	12.5	17.5	1.6	20
190970	12.5	19	1.6	20
190110	6.4	9.5	1.6	20
190111	8	10.6	1.6	20
190112	9.5	12.8	1.6	20
190114	12.5	15.5	1.6	20
190115	15.5	19	1.6	20

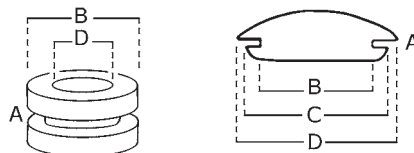
B mm	C mm	D mm	Amp	Qty.
190116	19	22.1	25.5	1.6
190958	22.5	27	28.5	1.6
190959	24.4	28.3	32	1.6



Cable Ties

804024

	L.	W.	Max dia.	Qty.
191003	..102 2.50 25 mm.....	200
191188	..150 3.60 39 mm.....	100
191094	..200 2.50 55 mm.....	200
190248	..190 4.80 52 mm.....	100
191128	... 92 2.40 16 mm.....	200
190014	Self adhesive 27 x 27 mm.			100

Special Hex Nuts

804028

	Spanner size mm		Qty.
190520 5.5 M3.....	200
190521 7 M4.....	200
191306 7 M4.....	200
190779 8 M5.....	200
191302 8 M5.....	200
190524 8 M5.....	200
190780 10 M6.....	200
191303 10 M6.....	200
190525 10 M6.....	200
190782 13 M8.....	200
191304 13 M8.....	100
190527 13 M8.....	200

	Spanner size mm		Qty.
191307 8 M5.....	200
191308 10 M6.....	100
191513 13 M8.....	50

Special Fuses

804032

	Type	Amp	Qty.
191152 Pink 30 5
191153 Green 40 5
191154 Yellow 60 5
191155 Pink 30 5
191156 Yellow 60 5
191157 Black 80 5
191184 Strip 30 10
191185 Strip 40 10
191186 Strip 50 10
191187 Strip 60 10
191188 Strip 80 10
191189 Strip 100 10
191249 Yellow 20 5
191250 Green 30 5

	Type	Amp	Qty.
191251 Orange 40 5
191252 Red 50 5
191253 Blue 60 5
191254 Beige 70 5
191255 Natural 80 5
191256 Violet 100 5

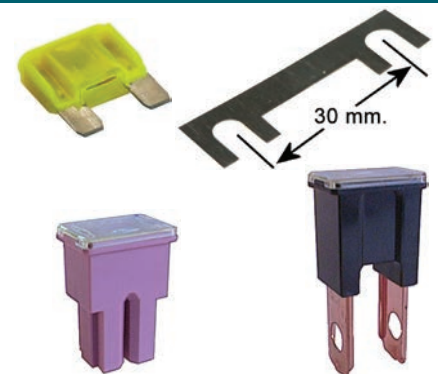
Continental & Glass Fuses

804036

	Dim. mm	Amp	Qty.
190285 20 x 5 0.5 20
190286 20 x 5 2 20
190284 20 x 5 6.3 20
190734 20 x 5 10 20
191534 20 x 5 20 20
190276 25 x 6 5 100
190277 25 x 6 8 100
190278 25 x 6 16 100
190279 25 x 6 25 100
190280 25 x 6 40 100
190735 29 x 6.3 10 20
191570 29 x 6.3 15 20
190736 29 x 6.3 25 20
190287 32 x 6.3 5 20

	Dim. mm	Amp	Qty.
190288 32 x 6.3 10 20
190289 32 x 6.3 15 20
190274 32 x 6.3 20 20
190275 32 x 6.3 35 20



Machine screws & nuts
804037

	Spanner size mm		Qty.
190520	5.5	M3	200
190521	7	M4	200
190779	8	M5	200
190780	10	M6	200

	Length mm.	Qty.
190531	M3 x 10	200
191770	M4 x 8	200
190536	M4 x 10	200
191317	M4 x 14	200
191318	M4 x 18	200
190540	M4 x 25	200
190541	M4 x 30	200
191319	M5 x 6	200
190544	M5 x 10	200
190547	M5 x 20	200
190552	M6 x 10	100

Mini Clamps
804040

	Min mm	Max mm	Ref. no.	Qty.
190005	6	8.3	8	15
190006	7	9.3	9	15
190007	8	10.3	10	15
190008	9	11.3	11	15
190009	9	12.3	12	10
190010	10	13.3	13	10
190937	11	14.3	14	10
190938	12	15.3	15	10

PE cone caps
804041

	OD mm	ID mm	H mm	No.	Qty.
191364	4.8/5.5	3.2/4	6.5	3	100
191365	6/6.7	4.9/5.9	7.8	6	100
191367	7.6/8.5	6/7.1	8.8	8	100
191368	8.2/9.2	6.6/7.8	10	10	100
191369	9.8/11	8.1/9.5	10.9	12	50
191370	10.8/12.3	9/10.6	10.4	15	50
191371	11.4/12.7	9.9/11.3	10.8	16	50
191372	13.1/14.5	11.5/13	12	18	30
191373	13.9/15.4	12.2/14	13.1	20	30
191374	14.2/15.7	12.7/14.7	13.6	25	30
191375	15.2/16.9	13.9/15.7	13.9	27	50
191480	17.2/19	15.5/17.5	14.7	30	40
191376	18.3/19.9	16.3/19	14.8	35	40

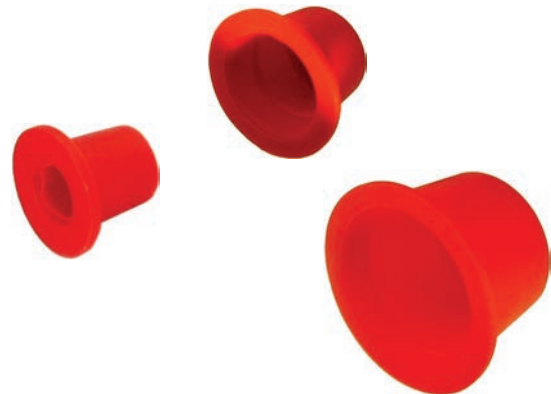
Red Crimp Terminals - Insulated
804048

	mm	Qty.
190049	Flat plug	2.8 ... 100
190045	Flat plug	4.7 ... 100
190022	Flat plug	6.3 ... 100
190025	Flat plug and piggi back	6.3 ... 50
190985	Flat plug, fully insulated	6.3 ... 100
190019	Flat tongue	6.3 ... 100
190021	Round plug, O.D. 4 mm	100
190017	Round plug receptacle, I.D. 4 mm.	100
190028	Butt connector	100
191009	Butt connector	25
190038	Ring	3 ... 100
190027	Ring	4 ... 100
190031	Ring	5 ... 100
190015	Ring	6 ... 100

	mm	Qty.
191501	Spade	2 ... 100
190973	Spade	4 ... 100
190974	Pin	100



Blue Crimp Terminals - Insulated

804049

	mm	Qty.
190020	Flat plug.....6.3	100
190041	Flat plug.....8	50
190026	Flat plug, fully insulated ..4.7	50
190046	Flat plug, fully insulated ..6.3	100
190016	Flat tongue	6.3... 100
190023	Round plug, O.D. 5 mm.	100
190018	Round plug receptacle, I.D. 5 mm.50	
190001	Butt connector	100
191010	Butt connector	25
190257	Ring	3 100
190029	Ring	4 100
190032	Ring	5 100
190034	Ring	6 100
190039	Ring	8 100

	mm	Qty.
191067	Spade	4 100
190037	Spade	5 100
190952	Pin.....	100

Yellow Crimp Terminals - Insulated

804050

	mm	Qty.
190024	Flat plug.....6.3	50
190048	Flat plug.....9.5	50
191191	Flat tongue	6.3..... 50
190051	Round plug, O.D. 5 mm.	50
190050	Round plug receptacle, I.D. 5 mm.50	
190030	Butt connector	50
191011	Butt connector	25
190033	Ring	5 50
190035	Ring	6 50
190255	Ring	8 50
190042	Ring	10..... 50
191515	Ring	12.... 100
190953	Pin.....	100

PAL Fuses I (Slow Blow Fuses)

804052

Type	Amp	Qty.
191638	Blue	20 1
191152	Pink	30 3
191153	Green	40 3
191154	Yellow.....	60 3
191155	Pink	30 3
191156	Yellow.....	60 3
191157	Black	80 3
191628	Pink	30 3
191629	Green	40 3
191630	Red	50 3
191631	Yellow.....	60 3
191632	Brown.....	70 3
191633	Blue	30 2
191634	Green	40 2

Type	Amp	Qty.
191635	Red	50 3
191636	Yellow.....	60 3
191637	Brown.....	70 3

Cable Joints

804054

	mm ²	Ring	Qty.
190846	4.0 - 6.0	M6	50
190716	10.0	M6	20
190717	16.0	M6	20
190718	16.0	M8	20
190719	25.0	M8	10
190720	25.0	M10.....	10
191416	35.0	M8	10
190721	35.0	M10.....	10
190722	50.0	M8	10
190723	50.0	M10.....	10



Crimp Seal Terminals

804055

	Type	mm	Qty.		Type	mm	Qty.
191009	Butt connector	Red	10	191693	Spade	Red	4
191010	Butt connector	Blue	10	191694	Spade	Blue	4
191011	Butt connector	Yellow	10	191695	Spade	Blue	5
191682	Ring	Red	4	191696	Spade	Yellow	5
191685	Ring	Blue	4	191697	Flat plug, ful.insul.	Red	6.3
191689	Ring	Yellow	5	191698	Flat plug, ful.insul.	Blue	6.3
191683	Ring	Red	5	191699	Flat tongue	Red	6.3
191686	Ring	Blue	5	191700	Flat tongue	Blue	6.3
191684	Ring	Red	6				
191687	Ring	Blue	6				
191690	Ring	Yellow	6				
191688	Ring	Blue	8				
191691	Ring	Yellow	8				
191692	Ring	Yellow	10				

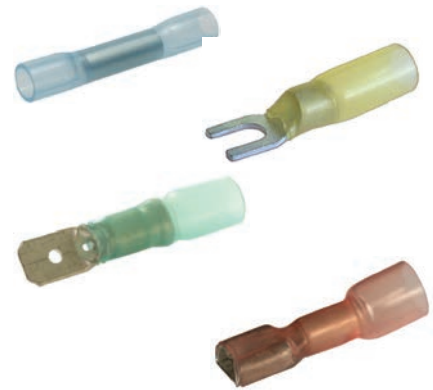

Solder Grip Terminals

804056

		Qty.			Qty.
191701	* Cable O.D. max 2.7 mm.	10	191711	*** Max. bundle O.D. 9.4 mm.	
191702	** Cable O.D. max 4.5 mm.	10		W/ glue	10
191703	*** Cable O.D. max 6 mm.	10	191713	**** Ring 6 mm.	
191704	**** Max. bundle O.D. 3.1 mm.	10		Max. bundle O.D. 3.9 mm.	10
191705	* Max. bundle O.D. 3.9 mm.	10			
191706	** Max. bundle O.D. 5.35 mm.	10			
191707	*** Max. bundle O.D. 7.15 mm.	10			
191708	**** Max. bundle O.D. 3.6 mm.				
	W/ glue	10			
191709	* Max. bundle O.D. 5 mm.				
	W/ glue	10			
191710	** Max. bundle O.D. 7.5 mm				
	W/ glue	10			

* = Red code, ** = Blue code,
*** = Yellow code, **** = Green code



Protection Plugs

804064

		Qty.
191857 M8-1	100
191858 M10-1	100
191859 M12-1	100
191860 M12-1.5	100
191861 M14-1.5	100



Protection Caps

804065

	H. mm	Qty.
191862 M8-1 10	100
191863 M10-1 10	100
191864 M12-1 12	100
191865 M12-1.5 12	100
191866 M14-1.5 12	100



Lock Washer

804068

	ID mm	Qty.
191277	M3.2	100
191278	M6	100
191573	M7	100
191279	M8	100
191280	M9	100
191270	M15	100
191271	M18	100
191333	M19	100
191272	M20	100
191273	M21	100
191274	M22	100
191481	M23	100
191275	M24	100
191276	M25	100

	ID mm	Qty.
191433	M27	100

Tapping Screws I

804069

	Dim. mm	Type no.	Qty.
191753	2.9 x 16	4	200
191798	2.9 x 19	4	200
190360	3.5 x 9.5	6	200
190361	3.5 x 16	6	200
190362	3.5 x 19	6	200
190366	4.2 x 9.5	8	200
190367	4.2 x 16	8	200
190368	4.2 x 19	8	200
190371	4.2 x 25	8	200
190372	4.8 x 13	10	200
190373	4.8 x 19	10	200

Cable Clips

804070

	Pipe OD	Type	Qty.
191950	3.2 mm	9.5	100
191951	4.8 mm	10.5	100
191952	6.4 mm	12.0	50
191953	7.9 mm	12.0	50
191954	9.5 mm	12.5	50
191955	12.7 mm	15.2	30
191956	15.8 mm	18.2	30
191957	19.4 mm	18.2	30
191958	25.4 mm	22.0	20
191959	31.8 mm	26.2	15

Butt Splices

804073

	mm ²	Qty.
192007	1.3	100
192008	2.0	100
191885	6.0	10
191886	10.0	10
191887	16.0	10
191888	25.0	10
191889	35.0	10
191890	50.0	10
191891	70.0	10



Super Seal Connectors

804075

	Qty.
192587 . Single wire seal Insulation dia.: 1.8-2.4 mm.	100
192091 . Single wire seal Insulation dia.: 2.6-3.3 mm.	100
192089 . Male. 1.5 mm. 1-1.5 mm ² .	100
192090 . Female. 1.5 mm. 1-1.5 mm ² .	100
192077 . Superseal.. 1 pole ..Male.....	5
192078 . Superseal.. 1 pole ..Female ...	5
192079 . Superseal.. 2 pole .. Female...	5
192080 . Superseal.. 2 pole ..Male.....	5
192081 . Superseal.. 3 pole ..Female ...	5
192082 . Superseal.. 3 pole ..Male.....	5
192083 . Superseal.. 4 pole ..Female ...	5
192084 . Superseal.. 4 pole ..Male.....	5

	Qty.
192085 . Superseal.... 5 pole. Female .	5
192086 . Superseal.... 5 pole. Male	5
192087 . Superseal.... 6 pole. Female .	5
192088 . Superseal.... 6 pole. Male	5



Pal Fuses II (Slow Blow Fuses)

804076

Type	Amp	Qty.
191638 ... Blue.....	20	1
191152 ... Pink.....	30	1
191153 ... Green.....	40	1
191154 ... Yellow.....	60	1
191970 ... Red.....	50	1
191830 ... Brown.....	25	1
191831 ... Green.....	30	1
191832 ... Red.....	45	1
191833 ... Black.....	65	1
191834 ... Grey.....	75	1
191672 ... Pink.....	30	1
191673 ... Green.....	40	1
191155 ... Pink.....	30	1
191973 ... Green.....	40	1

Type	Amp	Qty.
191974 ... Red.....	50	1
191156 ... Yellow.....	60	1
191975 ... Brown.....	70	1
191157 ... Black.....	80	1
191971 ... Darkblue.....	100	1
191628 ... Pink.....	30	1
191629 ... Green.....	40	1
191630 ... Red.....	50	1
191631 ... Yellow.....	60	1
191632 ... Brown.....	70	1
191972 ... Black.....	80	1
191977 ... Darkblue.....	100	1
191633 ... Pink.....	30	1
191634 ... Green.....	40	1

Type	Amp	Qty.
191635 ... Red.....	50	1
191636 ... Yellow.....	60	1
191637 ... Brown.....	70	1
191976 ... Black.....	80	1
191978 ... Darkblue.....	100	1

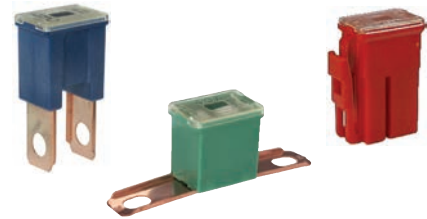

Heat Shrink Pipes

804077

mm before crimp	mm after crimp	Qty. mtr.
192069 ... 2.4.....	1.2	15
191874 ... 3.2.....	1.6	15
191875 ... 4.8.....	2.4	10
191876 ... 6.4.....	3.2	10
191877 ... 9.5.....	4.8	10
191878 ... 12.7.....	6.4	6
191879 ... 19.....	9.5	5
191880 ... 25.4.....	12.7	5

06219 Display stand.....1

 Shrinking temp. 120° - 250° C.
Shrink ration 2:1.

Single Core Cables

804078

Dim. mm	Length
190697 .. Black.....	1 x 1.5..... 100 m
190698 .. Red.....	1 x 1.5..... 100 m
190699 .. Blue.....	1 x 1.5..... 100 m
190700 .. Yellow.....	1 x 1.5..... 100 m
190702 .. Green.....	1 x 1.5..... 100 m

06219 Display stand..... 1

 1 x 1.5 mm². 30 / 0.250 mm. 16 Amp.

Tapping Screws

804079

	Dim. mm	Type no.	Qty.
192113	...3.5 x 9.56200
192114	...3.5 x 136200
192115	...3.5 x 166200
192116	...4.2 x 9.58200
192117	...4.2 x 138200
192118	...2.9 x 9.54200
192119	...3.5 x 9.56200
192120	...3.5 x 136200
192121	...4.2 x 9.58200
192122	...4.2 x 138200
192123	...4.2 x 168200
210859	...Type 1, L. 25 mm2
210860	...Type 2, L. 25 mm2

JT / JPT Connectors I

804080

		Qty.
192174	Male 2.8 mm. 0.35 - 1.5 mm ² 100
191551	Female terminal 0.5-1.5 mm ² 100
192155	Female terminal 1.5-2.5 mm ² 100
192166	2-pole male holder 2
192146	2-pole female holder 2
192150	Rubber boot for 2-pole. L. 57 mm.	2
192151	Rubber boot for 2-pole. L. 37 mm.	2
192149	7-pole female holder 2
192154	Rubber boot for 7-pole. L. 57 mm.	2

JT / JPT Connectors II

804081

		Qty.
192177	Single wire seal for 0.5-1.0 mm ² . cable 100
192178	Single wire seal for 1.5-2.5 mm ² . cable 100
192156	Male 2.8 mm. 0.5 - 1.0 mm ² 100
192175	Female terminal 0.5-1.0 mm ² 100
192157	Male 2.8 mm. 1.5 - 2.5 mm ² 100
192176	Female terminal 1.0-2.5 mm ² 100
192167	2-pole male holder, black 2
192147	2-pole female holder, black	... 3
192169	2-pole female holder, yellow	1
192152	Rubber boot for 2-pole. Angled	.. 4
192148	3-pole female holder, black	... 2
192171	4-pole female holder, black	... 1

		Qty.
192153	Rubber boot for 3-pole. L. 57 mm. 2
192172	5-pole female holder, black	... 2
192173	6-pole female holder, black	... 1

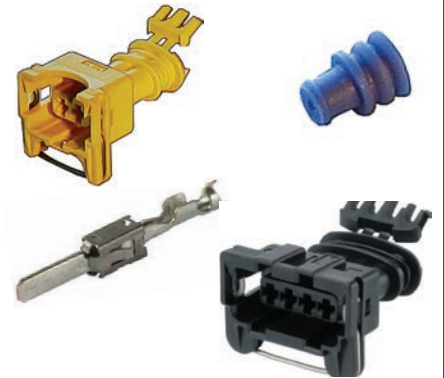
Cord End Terminals

804085

	mm ²	L. mm	Qty.
1919620.510100
1919630.7510100
191964110100
1919651.510100
1919662.510100
191967412100
191968615100
1919691015100
1920471618100



Mega Blade Fuses

804086

	Type	Amp	Qty.
192791	.. White	40	3
192792	.. White	60	3
192793	.. Red	80	3
192049	.. Yellow	100	3
192050	.. Green	125	3
192051	.. Tan	150	3
192052	.. White	175	3
192053	.. Blue	200	3
192229	.. Brown	225	3
192230	.. Pink	250	3
192231	.. Grey	300	3
192055	.. Fuse holder (Terminals : M8) ..		2

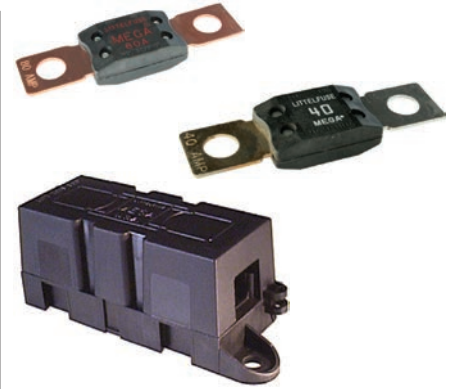

Allarm Battery

804088

	Qty.		Qty.
200772	.. Lithium Button Battery	200791	.. Alkaline Battery
200773	.. Lithium Button Battery		5
200774	.. Lithium Button Battery		
200775	.. Lithium Button Battery		
200802	.. Lithium Button Battery		
200813	.. Lithium Button Battery		
200854	.. Lithium Button Battery		
200858	.. Lithium Button Battery		
200779	.. Silver Oxide Button Battery		
200778	.. Alkaline Button Battery		
200792	.. Alkaline Button Battery		
200743	.. Alkaline Battery		
200776	.. Alkaline Battery		
200777	.. Alkaline Battery		



Battery Terminals II

804089

	Qty.
190012 Battery Terminal +
190013 Battery Terminal -
190202 Battery Terminal +
190203 Battery Terminal -
190213 Battery Terminal +
190214 Battery Terminal -
190866 Battery Terminal +
190867 Battery Terminal -



Strip Fuses

804090

	Qty.
192305 Fuse, 35 Amp
192306 Fuse, 50 Amp
192307 Fuse, 80 Amp
192308 Fuse, 100 Amp
192309 Fuse, 125 Amp
192310 Fuse, 160 Amp
192311 Fuse, 200 Amp
192312 Fuse, 250 Amp
192313 Fuse, 300 Amp
192314 Fuse, 355 Amp
192315 Fuse, 425 Amp
192316 Fuse, 500 Amp
192344 Fuse holder



PG Cable Glands

804091

Type	Qty.
192355 Mountinghole 12.1 mm. PG7	20
192356 Mountinghole 14.3 mm. PG9	15
192357 Mountinghole 18.23 mm. ... PG11	10
192358 Mountinghole 19.9 mm. ... PG13.5	8
192359 Mountinghole 22.1 mm. ... PG16	10
192360 Mountinghole 27.5 mm. ... PG21	10

Non Insulated Pin Terminals

804092

Dia.	mm ²	Qty.
191915 . 1.0	0.3-0.9	50
191916 . 1.0	0.3-0.9	50
191985 . 1.6	0.75-1.5	50
191543 . 1.6	1.0-2.5	50
191544 . 1.6	1.0-2.5	50
191074 . 2.1	1.0-2.5	50
191075 . 2.1	1.0-2.5	50
191091 . 2.1	0.5-2.1	50
191092 . 2.1	0.5-2.1	50
191563 . 3.5	0.5-2.0	50
191564 . 3.5	0.5-2.0	50
191078	0.5-2.5	50
191079	0.5-2.5	50

Insulated Terminals

804093

	Qty.
190001 Butt connector	10
190016 6.3 mm. flat tongue	10
190017 I.D. 4.0 mm. round plug receptacle	10
190019 6.3 mm. flat tongue	10
190020 6.3 mm. flat plug	10
190021 O.D. 4.0 mm. round plug	10
190022 6.3 mm. flat plug	10
190024 6.3 mm. flat plug	5
190026 6.3 mm. flat plug and piggyback	10
190028 Butt connector	10
190030 Butt connector	5
190031 5.0 mm. ring	10

	Qty.
190032 5.0 mm. ring	10
190035 6.0 mm. ring	5
190037 5.0 mm. spade	10
190042 10.0 mm. ring	5
190046 6.3 mm. flat plug, fully insulated	10
190050 I.D. 5.0 mm. round plug receptacle	5
190051 O.D. 5.0 mm. round plug	5
190952 Pin	10
190953 Pin	5
190973 4.0 mm. spade	10

	Qty.
190985 6.3 mm. flat plug, fully insulated	10
192142 6.0 mm. spade	5
210121 Crimping tool	1

Midi Blade Fuses

804094

Type	Amp	Qty.
192427 .. Pink	30	3
192428 .. Green	40	3
192429 .. Red	50	3
192430 .. Yellow	60	3
192431 .. Brown	70	3
192432 .. White	80	3
192433 .. Blue	100	3
192434 .. Tan	125	3
192435 .. White	150	3
192436 .. Fuse holder		2

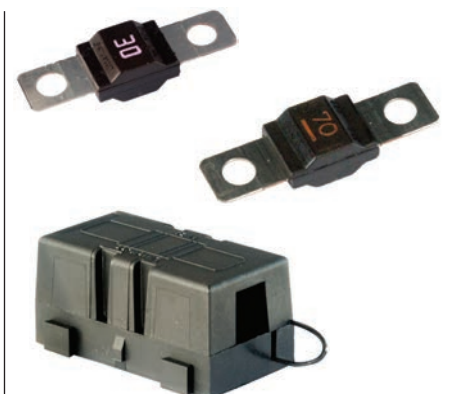

Insulated Crimp Terminals
804095

	Qty.
190049 Terminal 2.8 mm. red	100
190045 Terminal 4.7 mm. red	100
190022 Terminal 6.3 mm. red	100
190020 Terminal 6.3 mm. blue	100
190024 Terminal 6.3 mm. yellow	50
190041 Terminal 8.0 mm. blue	50
190048 Terminal 9.5 mm. yellow	50
190985 Terminal 6.3 mm. red	100
190046 Terminal 6.3 mm. blue	100
190025 Terminal 6.3 mm. red	50
190026 Terminal 6.3 mm. blue	50
190016 Terminal 6.3 mm. blue	100
190019 Terminal 6.3 mm. red	100
190021 Terminal, O.D. 4 mm. red ...	100

	Qty.
190023 Terminal, O.D. 4 mm. blue ..	75
190017 Terminal, I.D. 5 mm. red	100
191009 Shrinkable full insulated, red	25
191010 Shrinkable full insulated, blue	25
190028 Butt connector, red	100
190001 Butt connector, blue	100
190018 Terminal, blue	50
191011 Shrinkable full insul., yellow..	20



Mini Blade Fuses
804096

	Qty.
191465 2 Amp. Grey	10
191466 3 Amp. Violet.....	10
191467 4 Amp. Pink.....	10
191468 5 Amp. Tan.....	10
191469 7.5 Amp. Brown.....	10
191470 10 Amp. Red.....	10
191471 15 Amp. Blue.....	10
191472 20 Amp. Yellow	10
191473 25 Amp. Natural	10
191474 30 Amp. Green.....	10
210841 Extractor	1

ATO / Mini / Maxi Fuses
804097

	Qty.
190055 . 5 Amp. Tan, ATO.....	20
190056 . 7.5 Amp. Brown, ATO.....	20
190057 . 10 Amp. Red, ATO.....	20
190058 . 15 Amp. Blue, ATO.....	20
190059 . 20 Amp. Yellow, ATO.....	20
190060 . 25 Amp. Natural, ATO	20
190061 . 30 Amp. Green, ATO.....	20
191468 . 5 Amp. Tan, Mini	15
191469 . 7 Amp. Brown, Mini.....	15
191470 . 10 Amp. Red, Mini	15
191471 . 15 Amp. Blue, Mini	15
191472 . 20 Amp. Yellow, Mini	15
191473 . 25 Amp. Natural, Mini.....	15
191474 . 30 Amp. Green, Mini	15

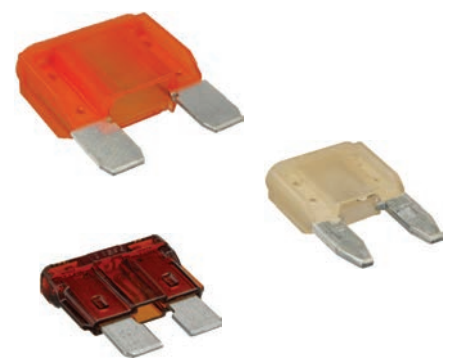
	Qty.
191250 . 30 Amp. Green, Maxi.....	3
191251 . 40 Amp. Orange, Maxi.....	3
191252 . 50 Amp. Red, Maxi.....	2
191253 . 60 Amp. Blue, Maxi.....	2

ATO / Mini / PAL Fuses
804098

	Qty.
190056 . 7.5 Amp. Brown, ATO.....	20
190057 . 10 Amp. Red, ATO.....	20
190058 . 15 Amp. Blue, ATO.....	20
190059 . 20 Amp. Yellow, ATO.....	20
190061 . 30 Amp. Green, ATO.....	20
191469 . 7 Amp. Brown, Mini.....	15
191470 . 10 Amp. Red, Mini	15
191471 . 15 Amp. Blue, Mini	15
191472 . 20 Amp. Yellow, Mini	15
191474 . 30 Amp. Green, Mini	15
191628 . 30 Amp. Pink, PAL.....	1
191629 . 40 Amp. Green, PAL.....	1
191630 . 50 Amp. Red, PAL	1

	Qty.
191152 . 30 Amp. Pink, PAL.....	20
191153 . 40 Amp. Green, PAL	1
191970 . 50 Amp. Red, PAL	1
191830 . 25 Amp. Brown, PAL	1
191831 . 30 Amp. Green, PAL	1



Maxi Blade Fuses I

804099

	Qty.
191249 .. 20 Amp. Yellow.....	2
191250 .. 30 Amp. Green.....	6
191251 .. 40 Amp. Orange.....	6
191252 .. 50 Amp. Red.....	4
191253 .. 60 Amp. Blue.....	4
191254 .. 70 Amp. Beige.....	2
191255 .. 80 Amp. Natural.....	2
210842 .. Extractor.....	1

DT Connectors

804100

	Qty.
192457 ..2-pole, female holder.....	3
192458 ..2-pole, male holder.....	3
192459 ..3-pole, female holder.....	3
192460 ..3-pole, male holder.....	3
192461 ..4-pole, female holder.....	3
192462 ..4-pole, male holder.....	3
192463 ..6-pole, female holder.....	3
192464 ..6-pole, male holder.....	3
192465 ..8-pole, female holder.....	3
192466 ..8-pole, male holder.....	3
192450 ..12-pole, female holder.....	3
192451 ..12-pole, male holder.....	3
192467 ..2-pole, Sekundary lock part...3	
192468 ..2-pole, Secondary lock part...3	

	Qty.
192469 ..3-pole, Secondary lock part...3	
192470 ..3-pole, Secondary lock part...3	
192471 ..4-pole, Secondary lock part...3	
192472 ..4-pole, Secondary lock part...3	
192473 ..6-pole, Secondary lock part...3	
192474 ..6-pole, Secondary lock part...3	
192475 ..8-pole, Secondary lock part...3	
192476 ..8-pole, Secondary lock part...3	
192452 ..12-pole, Secondary lock part.3	
192453 ..12-pole, Secondary lock part.3	
192477 ..Pin terminal.....	50
192478 ..Socket terminal.....	50

Heat Shrink Pipes

804101

	mm before crimp	mm after crimp	Qty. mtr.
191892	3	1	5
191893	6	2	3.5
191894	9	3	3
191895	12	4	2.5
191896	18	6	2
191897	24	8	1.5
06219 Display stand			1

Shrinking temp. 110° - 200° C.
Shrink ration 3:1.

Strip Fuses - Closed Type

804102

	Qty.	
192325	35 Amp.....	5
192326	50 Amp.....	5
192327	80 Amp.....	5
192328	100 Amp.....	5
192329	125 Amp.....	5
192330	160 Amp.....	5
192331	200 Amp.....	5
192332	250 Amp.....	5
192333	275 Amp.....	5
192334	300 Amp.....	5
192335	355 Amp.....	5
192336	425 Amp.....	5
192337	500 Amp.....	5
192344	Fuse holder.....	2

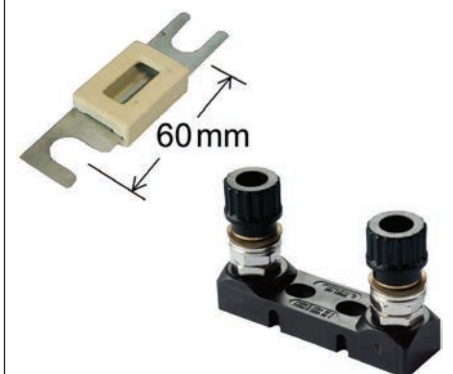

Compact Fuses

804104

	Qty.		Qty.
192538	50 Amp	2	
192539	75 Amp	2	
192540	100 Amp	2	
192541	125 Amp	2	
192542	150 Amp	2	
192543	175 Amp	2	
192544	200 Amp	2	
192545	250 Amp	2	
192546	300 Amp	2	
192547	Terminal for 1 fuse, Pos.	2	
192548	Terminal for 2 fuses, Pos.	2	
192549	Insulating nut for compact fuses	5	
			192557 Cable joint, 16 mm ² . M10 ..
			4
			190720 Cable joint, 25 mm ² . M10 ..
			4
			190721 Cable joint, 35 mm ² . M10 ..
			4



ATO - Blade Fuses Holders

804105

	Qty.
192631 ... Tan for 5 Amp fuses.	3
192632 ... Brown for 7.5 Amp fuses.	3
192633 ... Red for 10 Amp fuses.	3
192634 ... Blue for 15 Amp fuses.	3
192635 ... Yellow for 20 Amp fuses.	3
192636 ... Beige for 25 Amp fuses.	3
192637 ... Green for 30 Amp fuses.	3
191870 ... Spring terminal	100
191871 ... Spring terminal	100
191872 ... Spring terminal	50
192647 ... Single wire seal	100
191259 ... Fixing plate	3
192638 ... Fixing plate	3
192639 ... Fixing plate	3



Maxi Blade Fuses II

804106

	Qty.	
191249	20 Amp	10
191250	30 Amp	10
191251	40 Amp	10
191252	50 Amp	10
191253	60 Amp	10
191254	70 Amp	10
191255	80 Amp	10
191256	100 Amp	10
210842	Extractor	1
191775	Holder kit set	2



DTM Connectors

804107

	Qty.		Qty.
192619 ..	Male type	50	
192620 ..	Female type	50	
192596 ..	2-pole male holder	3	
192595 ..	2-pole female holder	3	
192608 ..	For 2-pole male holder	3	
192607 ..	For 2-pole female holder	3	
192598 ..	3-pole male holder	3	
192597 ..	3-pole female holder	3	
192610 ..	For 3-pole male holder	3	
192609 ..	For 3-pole female holder	3	
192600 ..	4-pole male holder	3	
192599 ..	4-pole female holder	3	
192612 ..	For 4-pole male holder	3	
192611 ..	For 4-pole female holder	3	
			192602 .. 6-pole male holder
			3
			192601 .. 6-pole female holder
			3
			192614 .. For 6-pole male holder
			3
			192613 .. For 6-pole female holder
			3
			192604 .. 8-pole male holder
			3
			192603 .. 8-pole female holder
			3
			192616 .. For 8-pole male holder
			3
			192615 .. For 8-pole female holder
			3
			192606 .. 12-pole male holder
			3
			192605 .. 12-pole female holder
			3
			192618 .. For 12-pole male holder
			3
			192617 .. For 12-pole female holder ...
			3



Micro Blade Fuses / Slow Blow Fuses
804109

Type	Amp	Qty.	Type	Amp	Qty.
192762 . Grey	2	10	192783 . Red	50	1
192763 . Violet	3	10	192784 . Yellow	60	1
192764 . Pink	4	10			
192765 . Tan	5	10			
192766 . Brown	7.5	10			
192767 . Red	10	10			
192768 . Blue	15	10			
192769 . Yellow	20	10			
192770 . Natural	25	10			
192771 . Green	30	10			
192779 . Blue	20	1			
192780 . White	25	1			
192781 . Pink	30	1			
192782 . Green	40	1			

Cable Lugs
804110

mm ²	Ring	Qty.	mm ²	Ring	Qty.
192906 4-6	M8	10	192924 35-50	M10	10
192908 6-10	M6	10	192925 35-50	M12	10
192909 6-10	M8	10	192926 50-70	M8	8
192910 6-10	M10	10	192927 50-70	M10	8
192911 10-16	M6	10			
192912 10-16	M8	10			
192913 10-16	M10	10			
192915 16-25	M6	10			
192916 16-25	M8	10			
192917 16-25	M10	10			
192920 25-35	M8	10			
192921 25-35	M10	10			
192922 35-35	M12	10			
192923 35-50	M8	10			

Circuit breakers
804111

	Qty.
192936 . 5 Amp Tan, ATO	2
192937 . 7.5 Amp Brown, ATO	2
192938 . 10 Amp Red, ATO	2
192939 . 15 Amp Blue, ATO	2
192940 . 20 Amp Yellow, ATO	2
192941 . 25 Amp White, ATO	2
192942 . 10 Amp 24 V, Maxi	2
192943 . 15 Amp 24 V, Maxi	2
192944 . 20 Amp 24 V, Maxi	2
192945 . 25 Amp 24 V, Maxi	2
192946 . 30 Amp 24 V, Maxi	2
192947 . 35 Amp 24 V, Maxi	2
192948 . 40 Amp 24 V, Maxi	2
192949 . 50 Amp 24 V, Maxi	2

Thin Wall Cables
804113

193012	1x0.35 mm ²	Black
193013	1x0.35 mm ²	Red
193014	1x0.5 mm ²	Black
193015	1x0.5 mm ²	Red

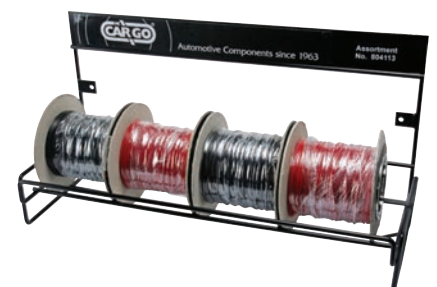

Micro / Mini Low Profile/ PAL Fuses

804117

	Qty.
193213 . 5 Amp. Tan, Micro	10
193214 . 7.5 Amp. Brown, Micro.....	10
193215 . 10 Amp. Red, Micro.....	10
193216 . 15 Amp. Blue, Micro.....	10
193217 . 20 Amp. Yellow, Micro.....	10
193218 . 25 Amp. Natural, Micro	10
193219 . 30 Amp. Green, Micro.....	10
192762 . 2 Amp. Grey, Mini.....	10
192763 . 3 Amp. Violet, Mini.....	10
192764 . 4 Amp. Pink, Mini	10
192765 . 5 Amp. Tan, Mini	10
192766 . 7.5 Amp. Brown, Mini	10
192767 . 10 Amp. Red, Mini	10
192768 . 15 Amp. Blue, Mini	10

	Qty.
192769 . 20 Amp. Yellow, Mini	10
192770 . 25 Amp. Natural, Mini.....	10
192771 . 30 Amp. Green, Mini	10
192779 . 20 Amp. Blue, PAL	2
192780 . 25 Amp. White, PAL	2
192781 . 30 Amp. Pink, PAL.....	2
192782 . 40 Amp. Green, PAL	2
192783 . 50 Amp. Red, PAL	2
192784 . 60 Amp. Yellow, PAL	2

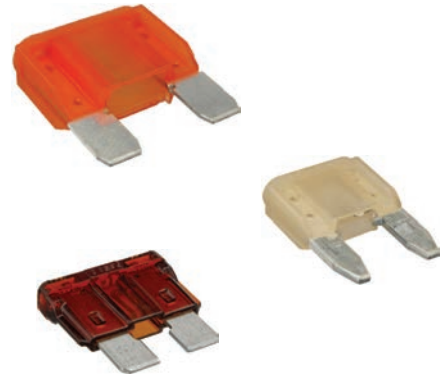

Thermal Washers

806011

	Qty.
080296 . Thermal washers, copper	10
080424 . Thermal washers, copper	10
080425 . Thermal washers, copper	10
080426 . Thermal washers, copper	10
080427 . Thermal washers, copper	10
080428 . Thermal washers, copper	10
080429 . Thermal washers, copper	10
080430 . Thermal washers, copper	10
080431 . Thermal washers, copper	10
080432 . Thermal washers, copper	10
080433 . Thermal washers, copper	10
080434 . Thermal washers, copper	10
080435 . Thermal washers, copper	10
080436 . Thermal washers, copper	10
080437 . Thermal washers, aluminium .	10

	Qty.
080438 . Thermal washers, copper	10
080439 . Thermal washers, copper	10
080440 . Thermal washers, copper	10
080441 . Thermal washers, copper	10
080442 . Thermal washers, copper	10
080443 . Thermal washers, copper	10
080444 . Thermal washers, copper	10
080446 . Thermal washers, copper	10
080447 . Thermal washers, copper	10
080448 . Thermal washers, copper	10
080449 . Thermal washers, steel/asbestos	10
080450 . Thermal washers, copper	10
080452 . Thermal washers, copper	10
080453 . Thermal washers, copper	10
080454 . Thermal washers, copper	10



Ring Nipples & Hose Sleeves

806015

	Qty.
080259 .. Hose sleeves.....	10
080260 .. Hose sleeves.....	10
080261 .. Hose sleeves.....	10
080262 .. Hose sleeves.....	10
080263 .. Hose sleeves.....	10
080264 .. Hose sleeves.....	10
080265 .. Hose sleeves.....	10
080237 .. Ring nipples	5
080238 .. Ring nipples	5
080239 .. Ring nipples	5
080240 .. Ring nipples	5
080241 .. Ring nipples	5
080242 .. Ring nipples	5
080243 .. Ring nipples	5

	Qty.
080245 .. Double hose nipples.....	5
080246 .. Double hose nipples.....	5
080247 .. Double hose nipples.....	5

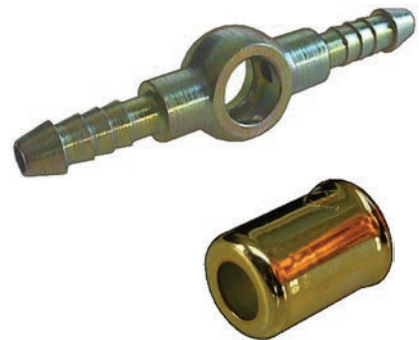

Hollow Screws & Hose Nipples

806020

	Qty.
080003 ... Hose nipples.....	3
080251 ... Hollow screws.....	5
080252 ... Hollow screws.....	5
080253 ... Hollow screws.....	5
080254 ... Hollow screws.....	5
080255 ... Hollow screws.....	10
080256 ... Hollow screws.....	10
080257 ... Double hollow screws.....	10
080258 ... Double hollow screws.....	10
080237 ... Hose nipples.....	3
080238 ... Hose nipples.....	3
080239 ... Hose nipples.....	3
080240 ... Hose nipples.....	3
080241 ... Hose nipples.....	3

	Qty.
080242 ... Hose nipples.....	3
080243 ... Hose nipples.....	3
080246 ... Double hose nipples.....	3
080247 ... Double hose nipples.....	3



Adjustment Shims I

806032

Thickness mm	Qty.
1.20	10
1.21	10
1.22	10
1.23	10
1.24	10
1.25	10
1.26	10
1.27	10
1.28	10
1.29	10
1.30	10

Adjustment Shims II

806033

Thickness mm	Qty.
1.20	10
1.24	10
1.26	10
1.28	10
1.30	10
1.32	10
1.34	10
1.36	10
1.38	10
1.40	10
1.42	10
1.44	10
1.46	10
1.48	10

Thickness mm	Qty.
1.50	10
1.52	10
1.54	10
1.56	10
1.58	10
1.60	10
1.62	10
1.64	10
1.68	10
1.70	10

Hose Nipples

807002

	Hose ID	Qty.
070009	R 1/8"	6.0 mm. ... 3
070067	R 1/4"	10.0 mm. ... 3
080855	R 1/2"	10.0 mm. ... 3
070077	1/8-27 NPTF	6.0 mm. ... 3
080955	1/8-27 NPFT	8.0 mm. ... 3
080857	1/2" -20 UNF	8.0 mm. ... 3
080960	1/2" -20 UNF	10.0 mm. ... 3
080954	M14-1.5	6.0 mm. ... 3
080854	M14-1.5	8.0 mm. ... 3
080959	M14-1.5	10.0 mm. ... 3
080858	M16-1.5	8.0 mm. ... 3
070070	M16-1.5	10.0 mm. ... 3
080958	M18-1.5	10.0 mm. ... 3

Toggle Switches

808014

	Qty.
180584	Toggle switch, 2 terminals ... 2
180585	Toggle switch, 3 terminals ... 2
180586	Toggle switch, 3 terminals ... 2
180587	Toggle switch, 3 terminals ... 2
180588	Toggle switch, 3 terminals ... 2
180589	Toggle switch, 3 terminals ... 2
180590	Toggle switch, 4 terminals ... 2
180591	Toggle switch, 6 terminals ... 2
180592	Toggle switch, 6 terminals ... 2
180593	Toggle switch, 6 terminals ... 2
180594	Toggle switch, 6 terminals ... 2
180595	Rubber cap ... 5



Mini Rocker Switches

808015

	Qty.
180597 ...2 terminals, On/Off,	10
180598 ...3 terminals, On/Off, amber.	10
180599 ...3 terminals, On/Off, red.....	10
180600 ...3 terminals, On/On.....	10
180601 ...3 terminals, On/Off, red spot diode	10
180628 ...3 terminals, On/Off, green..	10
180627 ...3 terminals, On/Off, blue ...	10



Mini Relays 12 V

811001

	Qty.
160080 ... 30 Amp 4 terminals.....	6
160081 ... 20/30 Amp 4 terminals	6
160083 ... 30 Amp 4 terminals.....	2
160155 ... 15 Amp 4 terminals.....	2
160168 ... 2 x 15 Amp 5 terminals	2
160239 ... 70 Amp 4 terminals.....	2
160265 ... 30 Amp 5 terminals.....	2
160270 ... 20/30 Amp 5 terminals	2
160282 ... 40 Amp 4 terminals.....	6
160308 ... 20/30 Amp 5 terminals	6
160403 ... 15/40 Amp 5 terminals	2
160468 ... 70 Amp 4 terminals.....	2



Micro Relays

811004

	Qty.
160363 25 Amp 4 terminals	2
160364 Normally open w/ diode	2
160365 Change over 12 V. 10/20 Amp....	2
160366 Change over w/ diode.....	2
160367 Change over w/ resistor	2
160368 Change over 24 V. 4/10 Amp. ...	1
160521 5/10 Amp. 5 terminals	2
191089 Terminal 4.7 mm. 0.5-1.0 mm ² . 100	
190868 Terminal 6.3 mm. 0.5-1.0 mm ² . 100	
190252 Terminal 6.3 mm. 1.0-2.5 mm ² . 100	
191752 Relay multi plug.....	10





Cross Reference List

OE No. - HC-CARGO No.

Edition 2014/2015



OE No.	HC-CARGO	OE No.	HC-CARGO	OE No.	HC-CARGO	OE No.	HC-CARGO
ALBA							
2761	171025	60805420	150246	77164000	170925	11787539137	181591
2762	171025	60805536	180630	77306000	170943	11787544654	181591
ALFA ROMEO							
105480632302/00	180704	60806108	181179	77309135	170944	11787544655	181591
113101101600	181585	60806379	180841	BERU			
113540402100	070054	60807244	180689	0040100013	150428	11787545074	181591
116080632300/00	180704	60807764	180630	0040100234	150252	11787545075	181591
116110402100	070053	60808223	181021	0040100259	150521	1179232	070053
116460102100	070054	60808371	180689	0040102038	150523	12121357296	150395
116460402100	070054	60809492	150246	0100226235	100339	12131317232	150250
116851101600	181584	60809606	150252	GR001	160420	12131402440	150250
116851101600/00	181584	60810259	181179	GR031	160421	12131404102	150250
116851104300	160352	60811198	180317	GR034	160432	12131703359	150250
116970632300/00	180704	60811423	181179	GR049	160442	12131726177	150250
116976507900	150065	608114715	181395	GR054	160436	12131726178	150250
116976507901	150055	60811534	180557	GR059	160423	12131727108	150250
119110402100	070053	60812240	180884	GR061	160451	12131730765	150250
119111101000	180874	60813321	180689	GR062	160439	12131731884	150250
119111101600	181584	60813687	180804	GR063	160452	12131734468	150250
161241101601	181585	60813751	180841	GR064	160416	12139066468	150250
162281101600	181585	60814507	180559	GR065	160424	12141244089	150056
164761113500	160354	60816553	150451	GR066	160424	12141244191	150056
19505104300	160353	705786	150055	GR067	160438	12141244226	150056
195051104300	160353	9946866	180875	ZM001	150055	12141244477	150056
241101601	181585	AMC		ZM002	150056	12141244481	150056
46410523	181179	3230451	150281	ZM003	150057	12141266702	150055
46469865	181395	3236666	181584	ZS038	150523	12141273217	150055
46469917	181495	3238765	181584	ZS234	150252	12141273298	150055
46472179	181395	3240083	181584	ZS259	150521	12141274698	150055
46481639	150451	33000598	181584	BMW			
46533308	181495	7700708955	181584	1115862	070053	12141461441	150379
46548037	150246	7700729963	181584	11621308366	181585	12411266702	150055
46806128	150451	8131941	150058	11621308367	181585	12512247471	192902
510621	180630	8134117	150062	11761277565	181584	12621710512	180841
5421620000000	150055	8933000598	181584	11761466063	181584	12621747281	180897
59469230	160354	8933002455	181584	11761707391	181585	1277565	181584
5963516	181584	8953000886	181584	11761714772	181586	12781405324	181588
60504190	180630	8953004243	181584	11761717472	181586	1317232	150250
605042880	150055	8983501087	150063	11781247406	181588	1354273	180648
60506902	180634	JO854136	181584	11781247475	181586	13621284397	180875
60506988	181009	TO708955	181584	11781266736	181584	13621357414	180874
60507256	180704	TO729963	181584	11781271670	181584	13621401945	180875
60507261	180704	ARIC		11781277565	181584	13621422567	181500
60507690	181585	33101000	171140	11781286638	181585	13621433565	181500
6051 81 310	181585	33140000	171141	11781286838	181585	13621709966	180875
60511741	180787	33150000	171143	11781310838	181585	13622242184	180884
60513205	180875	33153000	171144	11781310860	181585	13622247074	181500
60515838	180805	33634000	171147	11781405324	181588	13627787076	181500
60515839	180805	33635000	171148	11781464492	181589	13631273139	160416
60516857	180704	33673000	171153	11781468620	181586	13631276264	160352
60518131	181585	33909130	170635	11781468621	181586	1364272	181034
605183220	070054	33909132	170636	11781468630	181586	13712247002	181500
605219920	070054	42632000	171299	11781702951	181586	13781405324	181588
605228760	160352	42931000	171299	11781702951	181586	14781405324	181588
605229970	150055	42931536	171307	11781704259	181586	15781405324	181588
60523383	180874	42934000	171302	11781714772	181586	16121115862	070053
60533503	181104	42935000	171303	11781714873	181589	16141178751	070053
605343160	160353	42936000	171303	11781715263	181585	16141179232	070053
60537203	180985	42937000	171306	11781716114	181586	16141179415	070142
605460910	070053	42938000	171306	11781716156	181585	16141180504	070142
60549313	181001	42939000	171308	11781720019	181586	16141183139	070142
60549359	180317	42938000	171306	11781720536	181586	16781405324	181588
60558152	150252	42939000	171308	11781720672	181586	1710511	180841
605581530	150379	42939536	171312	11781720860	181586	1710535	180897
60564432	181001	42940000	171308	11781727451	181586	1727108	150250
60567759	181585	42940536	171312	11781730005	181586	1730520	150250
60573388	180884	42941000	171311	11781730007	181586	1734468	150250
60585603	181021	42942000	171311	11781734345	181586	17781405324	181588
60586072	150252	44847000	170998	11781734390	181586	1781405324	181588
60593845	180689	44847536	171000	11781734393	181586	19781405324	181588
60593846	180634	44848000	170999	11781735345	181586	20781405324	181588
60593847	180630	44849000	171098	11781735710	181586	21781405324	181588
60595694	180634	44904000	171329	11781738331	181586	22781405324	181588
60596248	180704	44904535	171330	11781739642	181586	23141352153	181160
60701852	180726	44905000	171328	11781741317	181586	23141354071	181160
60725114	180704	44954536	171162	11781742023	181586	23781405324	181588
60750065	150055	55631000	171164	11781747005	181586	24781405324	181588
60800167	180875	55632000	171165	11787530285	181590	25781405324	181588
		55951000	171166	11787530287	181590	26781405324	181588
		77163000	170927	11787539125	181591	27781405324	181588
		77163133	170989	11787539126	181591	28781405324	181588
						29781405324	181588
						30781405324	181588

OE No.	HC-CARGO	OE No.	HC-CARGO	OE No.	HC-CARGO	OE No.	HC-CARGO
31781405324	181588	0227100100	150056	0258001960	181584	0258003064	181586
32781405324	181588	0227100101	150056	0258001961	181584	0258003065	181588
61311243414	180648	0227100102	150055	0258001962	181584	0258003067	181586
61311350645	180734	0227100103	150056	0258001963	181584	0258003068	181586
61311351799	180634	0227100104	150056	0258001964	181584	0258003069	181586
61311352153	181160	0227100110	150055	0258002014	181584	0258003070	181587
61311354272	180648	0227100111	150055	0258002024	181584	0258003072	181585
61311354273	180648	0227100112	150055	0258002029	181584	0258003073	181585
61311354274	180648	0227100113	150056	0258002030	181584	0258003074	181589
61311357073	181034	0227100114	150154	0258002035	181584	0258003075	181585
61311364272	181034	0227100115	150154	0258002038	181584	0258003076	181589
61311368786	180734	0227100116	150056	0258002040	181584	0258003077	181585
61311378210	180801	0227100118	150056	0258002041	181584	0258003078	181589
61311378830	180734	0227100120	150074	0258002044	181584	0258003079	181587
61311379830	180734	0227100123	150055	0258002049	181584	0258003080	181585
61661367616	160197	0227100124	150098	0258002050	181584	0258003081	181585
61661368569	160197	0227100126	150154	0258002052	181584	0258003082	181585
61661368585	160197	0227100129	150154	0258002053	181584	0258003083	181587
61661368589	160197	0227100136	150154	0258002054	181584	0258003084	181585
61661380066	160680	0227100137	150056	0258002055	181584	0258003085	181587
64116923204	160765	0227100138	150056	0258002057	181584	0258003086	181585
64116929486	160765	0227100139	150056	0258002061	181584	0258003087	181589
64116931680	160765	0227100140	150057	0258002203	181584	0258003088	181586
64118364173	160765	0227100142	150075	0258002909	181584	0258003090	181585
64118377579	160765	0227100143	150075	0258002919	181584	0258003091	181587
64118383835	160765	0227100147	150075	0258003001	181585	0258003092	181587
64118385549	160765	0227100148	150055	0258003003	181585	0258003093	181585
		0227100200	150379	0258003004	181585	0258003094	181585
BOSCH		0227100201	150379	0258003005	181585	0258003095	181587
0130007001	160674	0227100203	150387	0258003006	181585	0258003096	181585
0130063008	160626	0227100204	150379	0258003008	181585	0258003097	181585
0130063013	160626	0227100208	150387	0258003009	181585	0258003099	181585
0130063015	160626	0227100209	150409	0258003010	181585	0258003101	181585
0130063032	160626	0227100210	150409	0258003011	181585	0258003102	181585
0130111003	160622	0227100211	150406	0258003012	181585	0258003103	181589
0130111162	160710	0227100212	150406	0258003013	181585	0258003104	181585
0130111164	160767	0227100213	150379	0258003014	181585	0258003105	181585
0210010001	160420	0227100214	150387	0258003015	181585	0258003106	181585
0221119023	150217	0227100215	150379	0258003016	181585	0258003108	181586
0221122349	150192	0227200005	150056	0258003017	181585	0258003109	181586
0221122409	150262	0232101009	150496	0258003018	181585	0258003112	181585
0221502431	150257	0232101023	150496	0258003019	181585	0258003113	181585
0221503001	150519	0232101030	150496	0258003020	181587	0258003114	181587
0221503003	150260	0232101031	150495	0258003021	181585	0258003115	181587
0221503014	150524	0232101032	150495	0258003023	181585	0258003116	181587
0221503407	150252	0232101038	150495	0258003024	181585	0258003117	181587
0221503417	150253	0232101039	150495	0258003025	181585	0258003118	181589
0221504410	150250	0250201933	160420	0258003026	181585	0258003119	181587
0221506002	150424	0250201952	160424	0258003027	181585	0258003120	181589
0221506003	150424	0258001012	181584	0258003028	181585	0258003122	181585
0221506444	150424	0258001014	181584	0258003030	181585	0258003123	181585
0221506445	150424	0258001021	181584	0258003031	181585	0258003125	181590
0221600005	150098	0258001025	181584	0258003032	181585	0258003127	181590
0221600006	150056	0258001026	181584	0258003034	181587	0258003128	181590
0221600008	150056	0258001027	181584	0258003035	181585	0258003129	181590
0221600011	150056	0258001028	181584	0258003036	181585	0258003130	181585
0221600015	150055	0258001029	181584	0258003037	181589	0258003131	181585
0221600017	150055	0258001031	181584	0258003038	181586	0258003132	181585
0221600052	150055	0258001032	181584	0258003039	181585	0258003133	181585
0221600053	150173	0258001035	181584	0258003040	181585	0258003134	181585
0221600055	150225	0258001037	181584	0258003041	181585	0258003135	181585
0221600057	150173	0258001038	181584	0258003043	181585	0258003136	181585
0221600060	150173	0258001039	181584	0258003044	181585	0258003137	181585
0221601001	150231	0258001040	181584	0258003045	181586	0258003138	181585
0221601002	150231	0258001041	181584	0258003046	180421	0258003139	181585
0221601003	150227	0258001042	181584	0258003046	181585	0258003140	181585
0221601004	150227	0258001043	181584	0258003047	181585	0258003141	181585
0221601005	150227	0258001044	181584	0258003048	181585	0258003142	181585
0221601006	150228	0258001047	181584	0258003049	181585	0258003143	181585
0221601007	150228	0258001051	181584	0258003050	181585	0258003144	181587
0221601452	150226	0258001052	181584	0258003051	181589	0258003145	181587
0221603006	150435	0258001060	181584	0258003052	181589	0258003146	181587
0221603009	150435	0258001061	181584	0258003054	181585	0258003147	181587
0221603010	150435	0258001062	181584	0258003056	181585	0258003148	181587
0221604008	150514	0258001063	181584	0258003057	181585	0258003149	181587
0227010001	150056	0258001064	181584	0258003058	181585	0258003150	181587
0227100023	150154	0258001097	181584	0258003059	181585	0258003151	181587
0227100024	150154	0258001248	181584	0258003060	181585	0258003152	181587
0227100029	150058	0258001929	181584	0258003061	181585	0258003153	181587
0227100042	150154	0258001931	181584	0258003062	181586	0258003154	181585
0227100043	150154	0258001947	181584	0258003063	181585	0258003155	181585

OE No.	HC-CARGO	OE No.	HC-CARGO	OE No.	HC-CARGO	OE No.	HC-CARGO
BOSCH continued							
0258003156	181585	0258003253	181589	0258003340	181590	0258003445	181585
0258003157	181585	0258003254	181587	0258003341	181590	0258003446	181585
0258003160	181585	0258003256	181585	0258003342	181590	0258003447	181585
0258003161	181585	0258003257	181585	0258003343	181590	0258003448	181585
0258003162	181585	0258003258	181587	0258003346	181587	0258003450	181589
0258003163	181586	0258003259	181589	0258003347	181587	0258003451	181589
0258003164	181585	0258003260	181586	0258003349	181585	0258003453	181586
0258003165	181585	0258003261	181586	0258003351	181587	0258003456	181590
0258003166	181585	0258003262	181589	0258003352	181589	0258003457	181590
0258003169	181587	0258003263	181585	0258003353	181586	0258003458	181588
0258003170	181587	0258003264	181585	0258003354	181586	0258003459	181588
0258003171	181587	0258003265	181284	0258003355	181589	0258003460	181586
0258003172	181587	0258003266	181284	0258003356	181588	0258003461	181585
0258003173	181585	0258003267	181284	0258003357	181586	0258003462	181589
0258003174	181585	0258003267	181586	0258003358	181589	0258003463	181589
0258003175	181585	0258003268	181284	0258003359	181586	0258003464	181589
0258003177	181590	0258003268	181586	0258003360	181589	0258003465	181586
0258003178	181590	0258003271	181586	0258003363	181587	0258003466	181589
0258003181	181585	0258003273	181585	0258003365	181589	0258003467	181590
0258003182	181585	0258003274	181585	0258003366	181589	0258003468	181590
0258003183	181590	0258003275	181590	0258003367	181589	0258003469	181589
0258003184	181590	0258003276	181585	0258003368	181589	0258003470	181588
0258003185	181590	0258003277	181585	0258003369	181588	0258003472	181590
0258003186	181590	0258003278	181587	0258003370	181585	0258003473	181585
0258003187	181590	0258003279	181585	0258003373	181589	0258003474	181585
0258003188	181590	0258003283	181585	0258003374	181588	0258003475	181588
0258003189	181585	0258003284	181585	0258003375	181588	0258003476	181588
0258003190	181585	0258003285	181587	0258003376	181585	0258003477	181588
0258003191	181587	0258003286	181585	0258003377	181587	0258003478	181588
0258003192	181587	0258003287	181585	0258003378	181587	0258003479	181588
0258003193	181589	0258003288	181586	0258003379	181587	0258003481	181590
0258003194	181585	0258003289	181586	0258003380	181587	0258003483	181585
0258003195	181586	0258003290	181589	0258003381	181585	0258003484	181590
0258003196	181586	0258003291	181589	0258003382	181590	0258003485	181590
0258003197	181586	0258003292	181589	0258003383	181590	0258003486	181590
0258003198	181586	0258003293	181585	0258003384	181590	0258003492	181590
0258003199	181586	0258003294	181585	0258003385	181590	0258003494	181590
0258003200	181586	0258003297	181585	0258003386	181590	0258003496	181590
0258003201	181585	0258003298	181585	0258003387	181590	0258003498	181590
0258003202	181586	0258003299	181585	0258003388	181590	0258003499	181590
0258003203	181589	0258003300	181585	0258003389	181590	0258003500	181590
0258003204	181586	0258003301	181589	0258003390	181589	0258003503	181585
0258003206	181585	0258003302	181589	0258003391	181586	0258003504	181585
0258003209	181585	0258003303	181589	0258003392	181590	0258003505	181585
0258003211	181585	0258003304	181589	0258003393	181585	0258003506	181590
0258003212	181585	0258003305	181587	0258003394	181588	0258003507	181590
0258003213	181585	0258003306	181587	0258003395	181588	0258003508	181585
0258003215	181586	0258003307	181590	0258003396	181585	0258003509	181585
0258003216	181589	0258003308	181587	0258003397	181585	0258003510	181585
0258003217	181589	0258003309	181589	0258003398	181590	0258003512	181586
0258003218	181590	0258003310	181586	0258003399	181590	0258003513	181589
0258003219	181586	0258003311	181585	0258003401	181590	0258003514	181589
0258003220	181586	0258003312	181585	0258003402	181590	0258003515	181589
0258003222	181589	0258003313	181585	0258003403	181586	0258003516	181589
0258003223	181590	0258003314	181586	0258003414	181588	0258003517	181586
0258003224	181590	0258003315	181586	0258003415	181588	0258003518	181588
0258003225	181590	0258003316	181586	0258003417	181585	0258003521	181590
0258003226	181590	0258003317	181586	0258003418	181585	0258003522	181586
0258003227	181590	0258003318	181589	0258003419	181585	0258003523	181586
0258003228	181590	0258003319	181589	0258003420	181585	0258003524	181585
0258003229	181589	0258003320	181589	0258003421	181585	0258003525	181585
0258003231	181586	0258003321	181589	0258003422	181587	0258003526	181588
0258003232	181585	0258003322	181589	0258003423	181590	0258003528	181586
0258003233	181585	0258003323	181589	0258003425	181588	0258003533	181590
0258003236	181586	0258003324	181589	0258003426	181586	0258003535	181590
0258003237	181586	0258003325	181589	0258003427	181586	0258003537	181590
0258003238	181589	0258003326	181586	0258003428	181586	0258003538	181586
0258003239	181589	0258003327	181586	0258003429	181586	0258003539	181586
0258003240	181589	0258003328	181586	0258003430	181586	0258003540	181589
0258003241	181587	0258003329	181586	0258003431	181586	0258003541	181590
0258003242	181587	0258003330	181590	0258003432	181586	0258003542	180485
0258003243	181585	0258003331	181585	0258003433	181586	0258003542	181588
0258003244	181586	0258003332	181585	0258003434	181586	0258003543	180485
0258003245	181585	0258003333	181589	0258003436	181588	0258003543	181588
0258003246	181585	0258003334	181284	0258003439	181284	0258003544	181590
0258003247	181587	0258003334	181586	0258003439	181586	0258003548	181586
0258003248	181587	0258003335	181588	0258003440	181284	0258003549	180485
0258003249	181587	0258003336	181588	0258003440	181586	0258003549	181586
0258003250	181587	0258003337	181585	0258003441	181587	0258003550	181588
0258003251	181589	0258003338	181586	0258003443	181586	0258003551	181588
0258003252	181589	0258003339	181590	0258003444	181586	0258003552	181588

OE No.	HC-CARGO	OE No.	HC-CARGO	OE No.	HC-CARGO	OE No.	HC-CARGO
0258003553	181588	0258003652	181585	0258003762	181590	0258003862	181588
0258003554	181587	0258003653	181585	0258003763	181587	0258003863	181588
0258003555	181587	0258003654	181588	0258003764	181587	0258003864	181588
0258003556	181590	0258003655	181588	0258003765	181587	0258003865	181588
0258003557	181590	0258003656	181588	0258003766	181587	0258003866	181586
0258003558	181588	0258003657	181588	0258003769	181589	0258003869	181586
0258003559	181588	0258003658	181588	0258003770	181589	0258003870	181590
0258003560	181586	0258003659	181590	0258003771	181588	0258003871	181590
0258003561	181588	0258003660	181590	0258003772	181589	0258003872	181590
0258003564	181588	0258003661	181588	0258003773	181588	0258003873	181590
0258003567	181589	0258003662	181588	0258003774	181585	0258003890	181590
0258003568	181589	0258003664	181586	0258003775	181590	0258003891	181590
0258003569	181585	0258003666	181284	0258003776	181590	0258003892	181585
0258003570	181589	0258003666	181586	0258003778	181590	0258003893	181590
0258003571	181589	0258003667	181589	0258003779	181590	0258003894	181590
0258003572	181589	0258003669	181589	0258003780	181590	0258003895	181588
0258003573	181589	0258003671	181589	0258003781	181590	0258003896	181588
0258003574	181589	0258003672	181589	0258003782	181588	0258003897	181585
0258003575	180485	0258003673	181589	0258003783	181588	0258003898	181585
0258003575	181586	0258003674	181586	0258003784	181586	0258003913	181585
0258003576	180485	0258003676	180485	0258003785	181586	0258003915	181585
0258003576	181586	0258003677	180485	0258003786	181586	0258003918	181585
0258003577	181588	0258003678	181590	0258003787	181586	0258003924	181585
0258003578	181589	0258003679	181590	0258003788	181586	0258003925	181585
0258003579	181589	0258003681	181590	0258003789	181586	0258003926	181585
0258003580	181588	0258003683	181590	0258003790	181586	0258003930	181585
0258003581	181588	0258003684	181588	0258003791	181586	0258003931	181585
0258003582	181588	0258003685	181588	0258003792	181586	0258003936	181585
0258003583	181588	0258003686	181589	0258003793	181586	0258003942	181585
0258003584	181589	0258003687	181586	0258003794	181588	0258003943	181585
0258003585	181589	0258003689	181588	0258003795	181588	0258003950	181585
0258003586	181586	0258003692	181588	0258003797	181588	0258003953	181585
0258003588	180485	0258003693	181588	0258003798	181588	0258003956	181585
0258003588	181586	0258003698	181588	0258003799	181588	0258003957	181585
0258003589	180485	0258003699	181588	0258003800	181588	0258003965	181588
0258003590	181590	0258003700	181586	0258003801	181588	0258003970	181587
0258003591	181590	0258003703	181585	0258003802	181588	0258003972	181585
0258003592	181588	0258003704	181585	0258003805	181589	0258003973	181585
0258003593	181588	0258003705	181586	0258003806	181588	0258003979	181587
0258003594	181588	0258003709	181586	0258003807	181588	0258003980	181585
0258003596	181586	0258003710	181586	0258003808	181589	0258003994	181585
0258003597	181586	0258003711	181590	0258003809	181589	0258003995	181587
0258003598	181586	0258003712	181590	0258003810	181586	0258003999	181585
0258003599	181586	0258003713	181590	0258003811	181588	0258005001	181590
0258003600	181586	0258003714	181590	0258003812	181588	0258005002	181590
0258003601	181586	0258003715	181585	0258003813	181590	0258005003	181588
0258003602	181586	0258003716	181589	0258003814	181590	0258005004	181588
0258003603	181588	0258003717	181589	0258003815	180485	0258005005	181588
0258003604	180485	0258003718	181589	0258003815	181590	0258005006	181588
0258003604	181586	0258003719	181589	0258003816	180485	0258005007	181588
0258003605	181586	0258003721	181588	0258003816	181590	0258005009	181590
0258003607	181590	0258003722	181588	0258003817	181588	0258005011	181590
0258003611	181588	0258003723	181588	0258003819	181590	0258005013	181590
0258003621	181590	0258003725	181590	0258003820	181588	0258005015	181590
0258003622	181585	0258003726	181590	0258003821	181585	0258005017	181590
0258003623	181585	0258003727	181590	0258003822	181585	0258005019	181590
0258003624	181585	0258003729	181590	0258003823	181588	0258005021	181590
0258003625	181585	0258003731	181590	0258003824	181588	0258005023	181590
0258003626	181588	0258003733	181590	0258003825	180485	0258005024	181588
0258003627	181589	0258003736	180485	0258003826	180485	0258005025	181588
0258003629	181590	0258003736	181588	0258003827	181585	0258005026	181588
0258003630	181588	0258003737	181588	0258003828	181585	0258005027	181588
0258003631	181588	0258003740	181588	0258003829	181586	0258005030	181586
0258003632	181586	0258003741	181588	0258003830	181586	0258005034	181590
0258003633	181586	0258003742	181585	0258003832	181585	0258005036	181590
0258003634	181585	0258003743	181585	0258003833	181585	0258005038	181590
0258003635	181585	0258003744	181587	0258003835	181590	0258005047	181589
0258003636	181589	0258003745	181588	0258003837	181590	0258005051	181589
0258003637	181589	0258003746	181588	0258003839	181590	0258005052	181590
0258003638	181588	0258003748	181588	0258003840	181588	0258005053	181590
0258003639	181588	0258003749	181588	0258003841	181585	0258005054	181588
0258003640	181588	0258003750	181588	0258003842	181588	0258005055	181590
0258003641	181588	0258003751	181588	0258003843	181588	0258005058	181586
0258003642	181588	0258003752	181588	0258003848	181588	0258005059	181586
0258003643	181588	0258003754	181586	0258003852	181585	0258005061	181590
0258003644	181590	0258003757	181588	0258003853	181585	0258005062	181588
0258003645	181588	0258003758	181588	0258003854	181588	0258005063	181588
0258003646	180485	0258003759	180485	0258003855	181590	0258005065	181588
0258003647	180485	0258003759	181590	0258003856	181590	0258005068	180485
0258003648	181589	0258003760	180485	0258003860	181588	0258005069	180485
0258003649	181589	0258003760	181590	0258003861	181588	0258005070	181590

OE No.	HC-CARGO	OE No.	HC-CARGO	OE No.	HC-CARGO	OE No.	HC-CARGO
BOSCH continued							
0258005071	181590	0258005183	181588	0258005289	181585	0258006021	181592
0258005074	181588	0258005184	181588	0258005292	181590	0258006022	181592
0258005078	181588	0258005185	181588	0258005293	181590	0258006026	181592
0258005079	181588	0258005186	181588	0258005294	181590	0258006027	181592
0258005080	181588	0258005187	181588	0258005295	181590	0258006028	181592
0258005081	181588	0258005189	181588	0258005296	181590	0258006029	181592
0258005082	181588	0258005191	181590	0258005297	181588	0258006033	181592
0258005083	181590	0258005192	181586	0258005298	181588	0258006034	181592
0258005084	181590	0258005197	181590	0258005302	181590	0258006035	181592
0258005087	181589	0258005200	181588	0258005303	181588	0258006037	181592
0258005088	181588	0258005201	181588	0258005304	181588	0258006039	181592
0258005089	181588	0258005202	181588	0258005305	181588	0258006040	181592
0258005090	181588	0258005203	181588	0258005306	181588	0258006042	181592
0258005091	181588	0258005205	181588	0258005308	181585	0258006046	181592
0258005092	181588	0258005206	181588	0258005309	181588	0258006047	181591
0258005093	181588	0258005207	181588	0258005310	181588	0258006049	181591
0258005094	181588	0258005208	181588	0258005311	181588	0258006050	181592
0258005095	181588	0258005209	181588	0258005312	181590	0258006051	181591
0258005096	181586	0258005210	181588	0258005314	181586	0258006052	181591
0258005097	181588	0258005213	181589	0258005315	181586	0258006053	181592
0258005098	181588	0258005214	181589	0258005316	181586	0258006055	181592
0258005099	181588	0258005215	181589	0258005317	181586	0258006056	181592
0258005109	181588	0258005216	181589	0258005318	181586	0258006057	181592
0258005110	181590	0258005219	181588	0258005321	181588	0258006058	181592
0258005112	181588	0258005220	181588	0258005322	181586	0258006061	181592
0258005113	181588	0258005221	181588	0258005323	181586	0258006063	181592
0258005115	181590	0258005222	181588	0258005324	181586	0258006064	181592
0258005116	181590	0258005223	181585	0258005325	181586	0258006072	181592
0258005119	181588	0258005224	181585	0258005327	181586	0258006091	181592
0258005121	181588	0258005226	181589	0258005328	181585	0258006093	181592
0258005123	181588	0258005227	181589	0258005329	181585	0258006095	181592
0258005124	181588	0258005228	181586	0258005334	181585	0258006096	181592
0258005125	181589	0258005229	181586	0258005335	181588	0258006097	181591
0258005126	181586	0258005236	181588	0258005650	181590	0258006099	181592
0258005127	181586	0258005237	181588	0258005651	181588	0258006100	181592
0258005128	181586	0258005238	181585	0258005652	181588	0258006105	181591
0258005129	181586	0258005239	181585	0258005653	181588	0258006109	181592
0258005130	181586	0258005240	181590	0258005654	181590	0258006115	181592
0258005131	181586	0258005241	181590	0258005657	181589	0258006117	181592
0258005132	181588	0258005242	181590	0258005658	181590	0258006118	181592
0258005133	181588	0258005243	181590	0258005659	181590	0258006119	181592
0258005134	181590	0258005244	181588	0258005701	181587	0258006121	181592
0258005135	181590	0258005245	181588	0258005704	181590	0258006122	181592
0258005136	181590	0258005246	181587	0258005705	181590	0258006123	181592
0258005138	181588	0258005247	181588	0258005708	181590	0258006124	181592
0258005139	181588	0258005249	181590	0258005709	181590	0258006125	181592
0258005141	181590	0258005251	181590	0258005710	181590	0258006126	181592
0258005142	181590	0258005253	181590	0258005716	181590	0258006127	181592
0258005143	181588	0258005254	181590	0258005717	181590	0258006128	181592
0258005144	181588	0258005255	181590	0258005718	181590	0258006135	181591
0258005147	181586	0258005256	181590	0258005719	181590	0258006137	181591
0258005148	181586	0258005257	181586	0258005721	181590	0258006143	181592
0258005149	181586	0258005258	181588	0258005722	181590	0258006146	181592
0258005150	181586	0258005259	181588	0258005730	181590	0258006153	181592
0258005151	181586	0258005260	181587	0258005734	181590	0258006155	181592
0258005152	181586	0258005261	181590	0258005735	181590	0258006156	181592
0258005153	181588	0258005262	181590	0258005736	181590	0258006159	181592
0258005154	181588	0258005263	181590	0258005737	181590	0258006160	181592
0258005155	181588	0258005264	181590	0258005785	181590	0258006161	181592
0258005156	181589	0258005265	181590	0258005786	181590	0258006162	181592
0258005157	181589	0258005266	181590	0258005845	181590	0258006163	181592
0258005160	181588	0258005267	181589	0258005846	181590	0258006164	181592
0258005161	181588	0258005268	181589	0258005955	181585	0258006165	181592
0258005162	181590	0258005269	181589	0258005957	181589	0258006166	181592
0258005163	181590	0258005270	181588	0258005959	181589	0258006167	181592
0258005164	181590	0258005271	181588	0258005961	181589	0258006168	181592
0258005169	181590	0258005272	181589	0258005965	181589	0258006169	181591
0258005170	181588	0258005273	181589	0258005967	181589	0258006170	181592
0258005171	181588	0258005274	181585	0258005973	181589	0258006171	181592
0258005172	181588	0258005275	181585	0258005975	181589	0258006172	181592
0258005173	181588	0258005276	181589	0258005977	181589	0258006173	181592
0258005174	181590	0258005277	181589	0258005985	181589	0258006174	181592
0258005175	181588	0258005278	181589	0258006010	181592	0258006175	181592
0258005176	181588	0258005279	181589	0258006013	181592	0258006176	181592
0258005177	181588	0258005280	181588	0258006014	181592	0258006177	181592
0258005178	181586	0258005281	181588	0258006015	181592	0258006179	181592
0258005179	180485	0258005283	181588	0258006016	181592	0258006180	181592
0258005179	181588	0258005284	181589	0258006017	181592	0258006181	181592
0258005180	181588	0258005285	181589	0258006018	181592	0258006182	181592
0258005181	181587	0258005286	181589	0258006019	181591	0258006183	181592
0258005182	181588	0258005287	181589	0258006020	181592	0258006184	181592

OE No.	HC-CARGO	OE No.	HC-CARGO	OE No.	HC-CARGO	OE No.	HC-CARGO
BOSCH continued							
0258986716	181591	0281002309	181494	0335200004	160242	0580464016	070053
0258986718	181591	0281002318	181491	0335200005	160244	0580464017	070054
0258986719	181591	0281002319	181491	0335200006	160244	0580464019	070053
0258986720	181591	0281002403	181497	0335200012	160242	0580464020	070054
0261210114	150354	0281002404	181497	0335200013	160242	0580464021	070054
0261210148	150453	0281002428	181495	0335200016	160244	0580464022	070054
0261210151	150468	0281002429	181497	0335200017	160244	0580464023	070053
0261210179	150453	0281002430	181497	0335200022	160242	0580464024	070054
0261210200	150470	0281002447	181495	0335200023	160242	0580464025	070054
0280122001	180317	0281002448	181495	0335200027	160242	0580464027	070054
0280122003	180317	0281002461	181491	0335200028	160242	0580464028	070054
0280122004	180317	0281002462	181491	0335200029	160244	0580464032	070053
0280122008	180317	0281002463	181491	0335200030	160244	0580464033	070053
0280130023	180874	0281002464	181491	0335200031	160244	0580464037	070054
0280130026	180875	0281002473	181395	0335200035	160242	0580464038	070053
0280130033	180875	0281002474	150451	0335200036	160242	0580464042	070054
0280130053	180919	0281002478	181491	0335200037	160244	0580464044	070054
0280130054	180919	0281002531	181491	0335200038	160242	0580464045	070054
0280130055	180884	0281002532	181491	0335200041	160244	0580464048	070053
0280130068	180875	0281002554	181495	0335200043	160242	0580464050	070053
0280130077	180875	0281002555	181495	0335200044	160244	0580464069	070054
0280130093	181395	0281002613	181495	0335200045	160242	0580464070	070053
0280130094	181395	0281003005	160432	0335200050	160305	0580810046	070053
0280130107	180875	0281003006	160434	0335200051	160305	0584640020	070053
0280217114	181500	0281003009	160436	0335200052	160242	0928400314	181500
0280217115	181500	0281003012	160434	0335200053	160242	0928400527	181500
0280217121	181491	0281003096	160449	0335200054	160242	0986221001	150505
0280217122	181491	0281003098	160419	0335200058	160242	0986221011	150428
0280217123	181495	0281003099	160421	0335200066	160242	0986221023	150509
0280217124	181500	0290800022	150100	0335200067	160244	0986221024	150508
0280217515	181500	0290800028	150407	0335200068	160242	0986258006	181588
0280217516	181500	0290800036	150407	0335200073	160242	0986280206	181491
0280217517	181500	0290800044	150408	0335200075	160242	0986280208	181493
0280217518	181500	0290800052	150101	0335200078	160243	0986280210	181491
0280217529	181492	0311424007	171194	0335200160	160263	0986280211	181491
0280217530	181492	0311424008	171195	0335215140	160262	0986280217	181491
0280217532	181500	0311425002	171199	0335215143	160262	0986280223	181491
0280217810	181500	0311425003	171201	0335215150	160199	0986280230	181494
0280217811	181500	0332014119	160282	0335215154	160199	0986280231	181495
0280217814	181500	0332014125	160265	0335402009	160262	0986284002	181491
0280218001	181495	0332014150	160265	0341003004	181599	0986284004	181497
0280218002	181493	0332014151	160265	0344101032	180634	0986284005	181497
0280218003	181493	0332014203	160266	0344101033	180634	0986284007	181491
0280218004	181495	0332014409	160083	0344101036	180630	0986284008	181491
0280218010	181500	0332015001	160168	0344101040	180648	0986284009	181491
0280218012	181495	0332015002	160169	0344101044	180634	0986345001	180641
0280218013	181491	0332017100	160365	0344101056	180634	0986345004	180638
0280218014	181491	0332017103	160363	0344101060	180631	0986345006	180638
0280218017	181493	0332201201	160337	0344101067	180630	0986345007	180657
0280218018	181493	0332204101	160308	0344101071	180636	0986345008	180641
0280218019	181495	0332204113	160308	0344101082	180635	0986345011	180638
0280218031	181494	0332204125	160081	0344101085	180634	0986345017	180641
0280218032	181491	0332204150	160081	0344101086	180636	0986619333	210678
0280218033	181491	0332204151	160308	0354010001	190273	0986619334	210773
0280218034	181491	0332204202	160337	0354010001	191012	0986619336	210774
0280218035	181491	0332204203	160216	0392020024	070192	1003450010	191585
0280218037	181494	0332204212	160271	0392020026	070206	1003450048	191585
0280218051	181495	0332204402	160316	0392020034	070203	1120940048	181500
0280218063	181491	0332207104	160366	0580453053	070142	1137101025	150057
0280218064	181491	0332207202	160368	0580453076	070053	1194485402	190259
0280218100	181491	0332207402	160521	0580453906	070071	1194485404	190762
0280218101	181491	0332209159	160403	0580453916	070071	1221122409	150262
0280218108	181495	0332515022	160654	0580453917	070071	1227010001	150056
0280218471	181491	0333300003	180290	0580453918	070071	1227010002	150055
0280230001	160352	0333301007	180232	0580453919	070071	1227010003	150098
0280230005	160352	0333301009	180233	0580453928	070071	1227010004	150056
0280230006	160354	0333402501	160423	0580453929	070071	1227010005	150098
0280230009	160353	0333402505	160441	0580463010	070053	1227010006	150098
0280230014	160354	0333402506	160441	0580463011	070053	1227010008	150055
0280230016	160352	0333402507	160443	0580463012	070053	1227010014	150065
0280230018	160353	0333402508	160443	0580463013	070053	1227010039	150098
0281002169	181395	0333402509	160424	0580463014	070053	1227022003	150065
0281002170	181395	0333402512	160420	0580463015	070053	1227022008	150056
0281002180	181494	0333402513	160425	0580463016	070053	1227022017	150057
0281002184	181495	0333402515	160442	0580463017	070053	1227022018	150057
0281002209	181395	0333402516	160442	0580464008	070053	1227022028	150173
0281002214	150451	0333402517	160424	0580464010	070053	1227022030	150171
0281002216	181496	0333402524	160425	0580464011	070053	1227022031	150057
0281002217	181496	0333402525	160430	0580464013	070053	1227022034	150226
0281002224	181497	0334200045	160242	0580464014	070053	1227030030	150171
0281002308	181494	0335200003	160242	0580464015	070053	1227030049	150172

OE No.	HC-CARGO	OE No.	HC-CARGO	OE No.	HC-CARGO	OE No.	HC-CARGO
1227622018	150057	FOOHL00182	181590	NU11-7T1	191305	3000598	181584
1237010014	150065	FOOHL00183	181590	NW1-14Z1	191290	3236666	181584
1237010028	150057	FOOHL00184	181590			3238765	181584
1237010029	150057	FOOHL00185	181590	CHEVROLET		33004243	181584
1237010031	150057	FOOHL00186	181590	96419956	181590	4004 675	181584
1237010038	150057	FOOHL00187	181590			4275685	181584
1305320816	170620	FOOHL00191	181590	CHRYSLER		4301 175	181584
1305320818	170621	FOOHL00192	181590	03000 598	181584	4301 246	181584
1305620959	171252	FOOHL00196	181584	03236 666	181584	4301 275	181584
1315601902	171237	FOOHL00198	181590	03238 765	181584	4301 346	181584
1901321209	191016	FOOHL00199	181590	04004 675	181584	4301 375	181584
1928403874	192902	FOOHL00202	181589	04275 685	181584	4605270	181590
1928498061	192998	FOOHL00205	181585	04301 175	181584	4606 061	181587
2915011010	191305	FOOHL00206	181585	04301 246	181584	4606 069	181589
3334485007	190767	FOOHL00207	181590	04301 275	181584	4606 133AE	181590
3334485008	190766	FOOHL00208	181590	04301 346	181584	4606 135AD	181590
9187451002	160734	FOOHL00217	181590	04301 375	181584	4606 555AB	181590
9220067031	150077	FOOHL00218	181590	04605 270	181590	4606 555AC	181590
9220067032	150077	FOOHL00219	181590	04606 061	181587	4606 555AD	181590
9222067034	150377	FOOHL00220	181590	04606 063	181590	4606 555AA	181590
9580810046	070053	FOOHL00221	181590	04606 067	181590	4606 950AB	181585
F000ZS0212	150416	FOOHL00222	181590	04606 069	181589	4606063	181590
FOOHL00010	181589	FOOHL00224	181589	04606 071	181590	4606067	181590
FOOHL00014	181589	FOOHL00225	181589	04606 075	181590	4606071	181590
FOOHL00030	181584	FOOHL00226	181590	04606 090	181590	4606075	181590
FOOHL00031	181584	FOOHL00227	181589	04606 422	181590	4606090	181590
FOOHL00034	181590	FOOHL00230	181590	04606 523	181590	4606133AB	181590
FOOHL00035	181584	FOOHL00233	181585	04606 523	181590	4606133AB	181590
FOOHL00036	181590	FOOHL00234	181589	04606 950	181590	4606135AB	181590
FOOHL00037	181584	FOOHL00235	181590	04606133AB	181590	4606422	181590
FOOHL00038	181585	FOOHL00236	181590	04606133AC	181590	4606523	181590
FOOHL00042	181590	FOOHL00237	181589	04606133AE	181590	4606950	181590
FOOHL00043	181590	FOOHL00238	181589	04606135AB	181590	4671 030	181590
FOOHL00050	181590	FOOHL00239	181590	04606135AD	181590	4671 052	181591
FOOHL00052	181590	FOOHL00240	181590	04606555AB	181590	4671052	181591
FOOHL00054	181590	FOOHL00246	181590	04606555AC	181590	4686 935AB	181590
FOOHL00060	181590	FOOHL00248	181590	04606555AD	181590	4686 938AB	181590
FOOHL00061	181590	FOOHL00254	181590	04606555AA	181590	4686120	181590
FOOHL00063	181590	FOOHL00255	181590	04606950AB	181585	4686621	181590
FOOHL00065	181590	FOOHL00257	181590	04671 030	181590	4686622	181590
FOOHL00083	181585	FOOHL00267	181590	04671 052	181591	4686723	181590
FOOHL00085	181590	FOOHL00271	181590	04686 120	181590	4686934	181590
FOOHL00086	181590	FOOHL00303	181590	04686 621	181590	4686934AB	181590
FOOHL00088	181590	FOOHL00305	181588	04686 622	181590	4686938AA	181590
FOOHL00103	181588	FOOHL00309	181590	04686 723	181590	4720598	180884
FOOHL00108	181589	FOOHL00311	181584	04686 934	181590	4727 225	181587
FOOHL00109	181590			04686934AB	181590	4727 436AB	181590
FOOHL00111	181590	CARGO		04686935AB	181590	4727225AB	181590
FOOHL00118	181590	170851	170980	04686938AB	181590	5014780AA	181584
FOOHL00120	181589	170857	170982	04686938AA	181590	5033 039AA	181590
FOOHL00123	181589	191836	192906	04727 225	181587	5033 081AA	181590
FOOHL00126	181589			04727225AB	181590	5033 200AA	181590
FOOHL00127	181584	CARTIER		04727436AB	181590	5033 500AA	181590
FOOHL00128	181589	02386	160423	05014780AA	181584	5099 817AA	181592
FOOHL00129	181590	02388	160423	05033039AA	181590	5099 821AA	181592
FOOHL00135	181590	02389	160424	05033081AA	181590	5139 021AA	181590
FOOHL00137	181589	02393	160425	05033200AA	181590	5227 268	181585
FOOHL00139	181590	02394	160424	05033500AA	181590	5227 368	181585
FOOHL00141	181588	02394	160424	05099817AA	181592	5227 628	181585
FOOHL00147	181588	02395	160429	05099821AA	181592	5234 921	181584
FOOHL00151	181590	02396	160438	05139021AA	181590	5269 711	181590
FOOHL00152	181590	02474	160354	05227 268	181585	5269 714	181590
FOOHL00153	181590			05227 368	181585	5269 868AB	181592
FOOHL00154	181590	CAV		05227 628	181585	5269 973	181590
FOOHL00155	181590	5001-10	190580	05234 921	181584	5269564	181590
FOOHL00156	181590	5001-26	190583	05269 564	181590	5269707	181590
FOOHL00157	181590	5001-31	190582	05269 707	181590	5269743	181590
FOOHL00158	181590	5244-22	190579	05269 711	181590	5269866	181590
FOOHL00161	181590	5334-476	192145	05269 714	181590	5293 038AB	181591
FOOHL00162	181585	5459-180	192246	05269 743	181590	5293036AB	181590
FOOHL00163	181585	5886-200C	191276	05269 866	181590	5293037AD	181590
FOOHL00165	181590	5936-487	190577	05269 973	181590	5293037AA	181590
FOOHL00166	181590	5936-495M	190593	052699868AB	181592	5293038AB	181591
FOOHL00167	181590	5936-495N	190594	05293036AB	181590	53000886	181584
FOOHL00168	181590	NS200-4T1	191266	05293037AD	181590	53002 106	181585
FOOHL00174	181590	NS209-10ZI	192065	05293037AA	181590	56027 978	181591
FOOHL00176	181590	NS209-14Z1	190549	05293038AB	181591	56027978	181591
FOOHL00178	181590	NS212-17Z1	192063	0M05269711	181590	56028232AA	181590
FOOHL00179	181590	NS212-2Z1	191321	12 578 576	181591	56028233AA	181591
FOOHL00180	181590	NU11-10T1	191439	12578576	181591	56028235AA	181591
FOOHL00181	181590	NU11-1T1	190520	258986507	181590	56028584AA	181590

OE No.	HC-CARGO	OE No.	HC-CARGO	OE No.	HC-CARGO	OE No.	HC-CARGO
CHRYSLER continued							
56028586AA	181591	MD089922	181584	MD607814	150096	89465-87210-000	181584
56028587AA	181591	MD107793	181584	MD611384	150096	89465-87211	181584
56028765AA	181590	MD108934	181584	MN158 757	181590	89465-87211-000	181584
56028766AA	181590	MD110487	181584	MN158 758	181590	89465-87212	181584
56028996AA	181590	MD110492	181584	MN158 759	181591	89465-87212-000	181584
56028997AA	181590	MD112479	150377	MN158759	181591	89465-87601	181584
56028998AB	181591	MD117240	181584	MR507 385	181590	89465-87601-000	181584
56028998AA	181590	MD119210	181584	MR507 386	181590	89465-87704	181584
56028999AA	181590	MD119609	181584	MR507 387	181591	89465-87704-000	181584
56029049AA	181590	MD121306	181584	MR507387	181591	89465-97203	181584
56029050AA	181590	MD127062	181584	MR560 365	181591	89465-97203-000	181584
56029084AA	181591	MD128262	181584	MR560364	181590	89465-97207	181591
56029085AA	181591	MD131446	181584	MR560365	181591	89465-97211	181590
56029112AA	181590	MD131447	181584	T1031135	150185	89465-97211-000	181590
56029333AA	181591	MD135140	181584			89465-97212	181590
56030100AA	181590	MD136 491	181590	COMMERCIAL IGNITION			
56030111AA	181590	MD136308	181590	EI11	150067	89465-97212-000	181590
56041 000	181590	MD136309	181584	EI14	150057	89465-97216	181590
56041 056	181586	MD136310	181590	EI15	150079	89465-97216-000	181590
56041000	181590	MD136493	181590	EI16	150068	89465-97217	181590
56041004	181590	MD137 224	181584	EI3	150065	89465-97217-000	181590
56041107	181590	MD137224	181584	EI4	150056	89465-97218-000	181591
56041212AB	181590	MD137274	181584	EI5	150055	89465-97221-000	181591
56041212AC	181590	MD140388	181584	EI7	150062	89465-97403	181591
56041212AF	181590	MD143 490	181591	EI8	150058	89465-97403-000	181591
56041213AB	181590	MD143490	181591	EI9	150072	89465-97405	181591
56041213AC	181591	MD148687	181584	XIC8063	150187	89465-97504	181591
56041213AE	181590	MD149813	181584	XIC8065	150196	89465-97508	181591
56041344AC	181591	MD164 422	181591	XIC8066	150217	89465-97509	181591
56041345AB	181591	MD164422	181591	XIC8067	150184	89465-B2100	181591
56041345AC	181591	MD164423	181591	XIC8068	150183	90048-52003	150395
56041345AD	181591	MD165083	181591	XIC8069	150243	90048-52010	150395
56041345AE	181591	MD181 398	181591	XIC8076	150185	90048-52022	150395
56041702AA	181590	MD181398	181591			90048-52026	150395
56041706AA	181590	MD182 691	181590	CUMMINS			
56041731AA	181591	MD182 793	181590	3164098	192902	90048-52028	150395
56041732AA	181591	MD183 145	181591			90048-52029	150395
56041845AA	181590	MD183 399	181591	DAEWOO			
56041846AA	181590	MD183145	181591	03439088	180808	90048-52030	150395
56041847AA	181590	MD183399	181591	16137039	180557	90048-52032	150395
56041848AA	181590	MD184 939	181591	90196375	180753	90048-52034	150395
56041887AA	181590	MD184939	181591	90245033	181182	90048-52038	150395
56041941AA	181591	MD185 334	181591	92927023	070053	90048-52039	150395
56041942AA	181591	MD185 335	181590	96192077	181182	90048-52044	150395
56041950AA	181590	MD185334	181591			90048-52045	150395
56041951AA	181590	MD186 392	181591	DAF			
56041952AA	181590	MD186 991	181590	1272653	170968	90048-52049	150395
56041953AA	181590	MD186 992	181591	1391484	192902	90048-52050	150395
56044215AA	181590	MD186392	181591			90048-52051	150395
56044580AA	181591	MD186990	181591	DAIHATSU			
56044581AA	181591	MD186992	181591	83420-87701	180811	90048-52054	150395
56044582AA	181591	MD188208	181590	83420-87701-000	180811	0014603	180340
56044583AA	181591	MD189 007	181591	83420-87702-000	180832	0014610	180341
8933000598	181584	MD189007	181591	83430-87101-000	181082	0014644	180339
8933002455	181584	MD192 071	181591	83530-14030-000	180641	0051734	192686
96 253 547	181591	MD192 072	181591	83530-87704-000	180638	113302	180287
96 291 086	181591	MD192 091	181591	83530-87705	180641	134711	191205
96 291 099	181591	MD192071	181591	83530-87705-000	180641	134712	191206
96 333 009	181591	MD192072	181591	89422-87202-000	180920	150300	192685
96 394 003	181591	MD192091	181591	89422-87701-000	180914	200140	180215
96 394 004	181591	MD302 068	181591	89465-14120	181591	206500	180529
96 423 429	181591	MD302068	181591	89465-87101	181584	250940	180156
96253547	181591	MD305 144	181590	89465-87101-000	181584	253002	180314
96291086	181591	MD305 145	181591	89465-87101-000	181584	259000	180158
96291099	181591	MD305 147	181591	89465-87102	181584	259991	180159
96333009	181591	MD305 149	181591	89465-87102-000	181584	290125	180229
96394003	181591	MD305145	181591	89465-87103-000	181584	300403	180045
96394004	181591	MD305147	181591	89465-87103-000	181584	300711	180324
96423429	181591	MD305149	181591	89465-87105	181584	327052	180025
M05269711	181590	MD307 258	181590	89465-87105-000	181584	327352	180043
MD003824	150395	MD311230	181590	89465-87106	181584	327432	181518
MD011 25	181584	MD313 819	181591	89465-87106-000	181584	327452	180027
MD011225	181584	MD313819	181591	89465-87108	181584	327499	181597
MD01125	181584	MD335 051	181591	89465-87108-000	181584	328062	180041
MD073036	181584	MD335051	181591	89465-87109	181584	330262	180044
MD073175	181584	MD345 230	181591	89465-87109-000	181584	330290	181595
MD073461	181584	MD345230	181591	89465-87201-000	181584	330291	181596
MD073546	181584	MD354 850	181590	89465-87202	181584	854000	170137
MD076706	181584	MD354 851	181590	89465-87202-000	181584	854600	170596
MD077621	181584	MD370045	181590	89465-87209-000	181584	SRB524	161011
MD088616	181584	MD607478	150068	89465-87210	181584		

OE No.	HC-CARGO	OE No.	HC-CARGO	OE No.	HC-CARGO	OE No.	HC-CARGO
DENSO		W8P	192476	S5050	S5050	A4652SK	190030
029700-6700	150281	W8S	192475	S5550	S5550	A4653R	190033
056700-4810	160480	WM12P	192618	S650	S650	A4665R	190035
071500-0340	180827	WM12S	192617	DUCELLIER			
071500-0430	180811	WM2P	192608	245509	150176	B0457H4	191016
071500-0710	180811	WM2S	192607	245510	150055	B0457H5	190283
071500-0960	180832	WM3P	192610	2526009	150184	B0907H5	191047
071800-0320	180641	WM3S	192609	2526009A	150184	B2507H	191415
071800-0410	180641	WM4P	192612	25260023	150185	B409FL	190868
071800-0620	180641	WM4S	192611	2526023A	150185	B409H	191549
131000-0011	150092	WM6P	192614	2526026	150247	B410FL	190252
131300-0011	150092	WM6S	192613	2526026A	150247	B410H	190270
131300-0033	150157	WM8P	192616	2526030	150243	B411FL	191029
131300-0072	150157	WM8S	192615	2526035A	150260	B411H	191028
131300-0073	150157	WP2P	193021	FACET			
131300-0120	150092	WP2S	193022	2526037A	150259	10.3001	180557
131300-0330	150157	WP4P	193023	2526040A	150259	10.3002	180558
131300-0341	150157	WP4S	193024	2526048	150185	10.3003	180559
131300-0600	150157	DOGA		2526049	150196	10.5002	180317
131300-0601	150157	100.5051.09.00	160615	2526049A	150196	10.7004	180337
131300-0610	150092	111.3756.2B.00	160503	2526055	150278	10.7006	181325
131301-0601	150157	111.3756.3B.00	160504	2526055A	150278	10.7008	181325
179700-0050	180914	111.9001.2B.00	160395	2526070	150217	10.7033	181284
DEUTSCH		111.9001.2B.00	160395	2526071	150192	10.7046	181282
0413-204-2005	192788	111.9604.3B.16	160345	2526073A	150432	10.7056	181284
0460-202-16141	192505	112.1340.2B.04	160558	2528001A	150176	10.7079	180421
0460-202-20141	192619	112.1380.2B.00	160031	254410	150055	10.7192	181284
0460-204-11817	192621	112.1380.3B.00	160032	520064	150185	10.7240	181282
0460-215-16141	192477	112.1540.2B.00	160506	520073	150183	10.7241	181282
0462-201-16141	192506	112.1580.3B.00	160034	520073A	150183	10.7299	180485
0462-201-20141	192620	113.2550.2B.00	160292	521007	150055	10.7426	180485
0462-201-16141	192506	113.2550.3B.00	160293	521008	150055	40107	070191
0462-203-12141	192622	113.5440.2B.00	160357	521013	150055	40159E	070058
0462-209-16141	192478	113.5623.2B.10	160290	DURACELL			
112263-90	192683	113.5623.3B.10	160291	D357	200779	40164	070056
112264	192684	115.7463.3B.10	160345	MN11	200776	40185	070057
DT04-08PA	192466	116.5365.2B.1E	160659	MN27	200777	476087E	070003
DT04-12	192451	116.5404.2B.D0	160725	PX625A	200778	476088	070004
DT04-2P	192458	116.5565.2B.D0	160258	ELPRESS			
DT04-3P	192460	116.5565.3B.D0	160408	A1504FL5	190045	50107	070191
DT04-4P	192462	121.0901.GA.16	160484	A1504HA	190021	60104	070187
DT04-6P	192464	127.0907.GA.04	160571	A1504HO	190017	60106	070188
DT06-12SA	192450	127.1601.GA.04	160608	A1507FL	190022	7.0000	180630
DT06-2P	192457	128.1204.00.04	161021	A1507FLF	190985	7.0001	180631
DT06-3S	192459	133.9015.UC.04	S650	A1507FLH	190025	7.0005	180630
DT06-4S	192461	133.9035.UB.04	S5050	A1507H	190019	7.0007	180634
DT06-6S	192463	13650070706	160727	A1519SR	190974	7.0008	180635
DT06-8S	192465	162.4102.2B.00	160005	A1525SK	190028	7.0010	180634
DTM04-12PA	192606	162.4102.3B.00	160006	A1532G	191501	7.0011	180636
DTM04-2P	192596	316.5369.30.14	161023	A1532R	190038	7.0014	180638
DTM04-3P	192598	316.5565.3B.D0	160408	A1537R	190027	7.0017	180641
DTM04-4P	192600	319.0724.30.00	161022	A1543G	190973	7.0021	180645
DTM04-6P	192602	319.1063.30.10	161025	A1553R	190031	7.0023	180630
DTM04-8PA	192604	319.1724.30.00	161024	A1565R	190015	7.0026	180648
DTM06-12SA	192605	B650S	S650	A2505HA	190023	7.0027	180649
DTM06-2S	192595	FU50	S5050	A2505HO	190018	7.0028	180649
DTM06-3S	192597	OF40	160840	A2507FL	190020	7.0031	180652
DTM06-4S	192599	OF45	160845	A2507FLF	190046	7.0042	180657
DTM06-6S	192601	OF48	160847	A2507FLH	190026	7.0045	180658
DTM06-8SA	192603	OF53	160853	A2507H	190016	7.0047	180660
DTP04-2P	193017	OF65	160865	A2508FL	190041	7.0056	180665
DTP04-4P	193019	OF70	160870	A2519SR	190952	7.0088	180638
DTP06-2S	193018	P100	160330	A2527SK	190001	7.0095	180688
DTP06-4S	193020	P40	160321	A2532R	190257	7.0096	180689
HDP24-24-19-SE	192650	P45	160322	A2537R	190029	7.0108	180694
HDP24-24-23-SE	192652	P50.1	160323	A2543C	191067	7.0141	181341
HDP24-24-31-SE	192656	P50.2	160324	A2553G	190037	7.0602	180702
HDP26-24-19-PE	192649	P60	160325	A2553R	190032	7.0605	180704
HDP26-24-23-PE	192651	P60.1	160326	A2565R	190034	7.1000	180726
HDP26-24-31-PE	192655	P60.2	130326	A2585R	190039	7.1005	180009
W12P	192453	P60.3	160326	A4605HA	190051	7.1007	180731
W12S	192452	P60.4	160326	A4605HO	190050	7.1010	180732
W2P	192468	P65	160327	A4607FL	190024	7.1014	180734
W2S	192467	P65.1	160327	A4607H	191191	7.1050	180753
W3P	192470	P65.2	160370	A4609FL	190048	7.1052	180755
W3S	192469	P70	160328	A4610R	190042	7.1055	180757
W4P	192472	P70.2	160411	A4613R	191515	7.1088	180783
W4S	192471	P702	160411	A4630SR	190953	7.1091	180785
W6P	192474	P80	160329	CROSS REFERENCE LIST			
W6S	192473	P90	160757				

OE No.	HC-CARGO	OE No.	HC-CARGO	OE No.	HC-CARGO	OE No.	HC-CARGO
FACET continued				FAE			
7.1123	180801	7.5187	181089	9.4021	150074	1061	180638
7.1129	181356	7.5201	181093	9.4024	150061	1106	180634
7.1132	181358	7.5604	181104	9.4025	150063	1107	180635
7.1149	181367	7.5620	181104	9.4027	150068	1120	180631
7.1151	181369	7.5624	181119	9.4028	150057	1126	180630
7.1158	181358	7.5626	181121	9.4029	150176	1127	180645
7.2004	180790	7.5635	181126	9.4030	150165	1138	180649
7.2005	180791	7.5638	181128	9.4031	150154	1140	180631
7.3000	180804	7.5639	181129	9.4032	150171	1146	180631
7.3002	180805	7.5650	181133	9.4033	150172	1161	180641
7.3004	180807	7.5682	181141	9.4036	150175	1163	180645
7.3005	180808	7.5690	181444	9.4038	150157	1169	180694
7.3008	180810	7.6007	181147	9.4044	150234	1204	180652
7.3009	180811	7.6009	181148	9.4047	150221	1218	180652
7.3010	180812	7.6011	181150	9.4052	150236	1222	180636
7.3018	180839	7.6015	181152	9.4053	150097	1242	180657
7.3028	180820	7.6019	181156	9.4055	150091	1291	180658
7.3042	180827	7.6021	181158	9.4056	150092	1293	180688
7.3052	180832	7.6028	7.6028	9.4064	150171	1342	180649
7.3073	180839	7.6029	181160	9.4068	150160	1352	180636
7.3077	180841	7.6039	181165	9.4070	150377	2101	180790
7.3086	180848	7.6056	181172	9.4076	150406	2102	180791
7.3099	180859	7.6067	181179	9.6005	150183	2108	180791
7.3101	180861	7.6073	181182	9.6006	150184	2401	180726
7.3113	180867	7.6075	181183	9.6007	150185	2402	180734
7.3124	180871	7.6077	181184	9.6008	150243	2407	180731
7.3127	180874	7.6078	181185	9.6010	150187	2413	180732
7.3128	180875	7.6096	181191	9.6025	150192	2415	180734
7.3140	181388	7.6099	181194	9.6035	150281	2431	180753
7.3146	180883	7.6102	181197	9.6040	150196	2442	180757
7.3147	180884	7.6108	181201	9.6046	150246	2444	180785
7.3165	180893	7.6109	181202	9.6054	150217	2445	180755
7.3176	180897	7.6113	181205	9.6055	150247	2457	180801
7.3191	180905	7.6125	181212	9.6059	150249	2459	180783
7.3198	180910	7.6140	181219	9.6062	150250	3028	180859
7.3211	180914	7.6215	181456	9.6067	150281	3029	180859
7.3223	180916	8.4702	150328	9.6068	150252	3102	180810
7.3229	180919	8.4976M	150148	9.6071	150253	3105	180805
7.3230	180920	8.7281	150152	9.6078	150257	3114	180804
7.3239	181395	9.0003	150332	9.6088	150259	3131	180827
7.3252	181397	9.0005	150333	9.6089	150260	3165	180916
7.3257	181400	9.0009	150336	9.6092	150262	3208	180812
7.3258	181400	9.0016	150340	9.6096	150419	3211	180839
7.3259	181402	9.0021	150343	9.6098	150266	3216	180811
7.3260	181402	9.0031	150343	9.6099	150267	3218	180807
7.3308	181373	9.0037	150442	9.6113	150269	3223	180808
7.3512	180928	9.0053	150354	9.6114	150270	3227	180841
7.3515	180931	9.0066	150360	9.6116	150272	3229	180867
7.3524	180937	9.0073	150361	9.6121	150273	3301	180875
7.4000	180945	9.0082	150445	9.6129	150275	3302	180874
7.4007	180949	9.0127	150366	9.6161	150275	3306	180905
7.4014	180950	9.0169	150451	9.6172	150278	3326	180893
7.4015	180951	9.0172	150453	9.6173	150519	3331	180920
7.4029	180953	9.0195	150414	9.6184	150279	3362	180848
7.4030	180954	9.0196	150404	9.6199	150394	3363	180861
7.4042	180959	9.0197	150460	9.6211	150281	3364	180883
7.4046	180961	9.0205	150453	9.6212	150281	3411	180937
7.4048	180963	9.0235	150468	9.6216	150424	3415	180931
7.4079	180985	9.0241	150470	9.6244	150426	3420	180931
7.4080	180986	9.0254	150470	9.6254	150428	3507	180945
7.4084	180987	9.0303	150481	9.6255	150429	3513	180950
7.4085	180988	9.0314	150485	9.6256	150430	3517	180953
7.4104	180995	9.0322	150491	9.6274	150432	3525	180963
7.4120	181000	9.0367	150495	9.6276	150415	3537	180953
7.5000	181001	9.0371	150496	9.6277	150433	3538	180954
7.5004	181005	9.0397	150336	9.6278	150434	3548	180988
7.5007	181008	9.0543K	150404	9.6279	150416	3549	180986
7.5008	181009	9.4001	150058	9.6279S	150416	3550(2)	180985
7.5018	181015	9.4002	150062	9.6280S	150416	3552	180949
7.5031	181021	9.4003	150064	9.6281	150435	3559	180995
7.5064	181034	9.4005	150055	9.6295	150416	3578	180959
7.5102	181055	9.4006	150057	9.6319	150441	3580	180959
7.5128	181064	9.4007	150075	9.8034	150403	3605	181077
7.5129	181065	9.4008	150065	9.8056	150293	3701	181001
7.5137	181070	9.4009	150072	9.8114	150227	3704	181008
7.5142	181073	9.4012	150067	9.8120	150435	3705	181005
7.5145	181076	9.4013	150077	Q-40106	070188	3708	181005
7.5146	181077	9.4014	150079			3712	181009
7.5154	181082	9.4015	150068			3718	181005
7.5155	181034	9.4019	150071			3722	181021
7.5182	181088	9.4020	150088				

OE No.	HC-CARGO	OE No.	HC-CARGO	OE No.	HC-CARGO	OE No.	HC-CARGO
3724	181065	4133922	180630	55193048	181494	7648797	150252
3725	181064	4141538	180945	55201610	181591	7648798	150379
3731	181001	4151243	180631	55218148	181591	76647630	160426
3734	181008	4151564	180631	55222112	181591	7672018	150246
3735	181005	4152127	180631	553310200	180638	7681395	180689
3738	181005	4163888	180945	55331172	181001	7696064	180557
3739	181005	4165210	180790	55354325	181341	7705830	180689
3742	181009	4169122	180945	553621201	180832	7706596	180689
3767	181064	4171667	180805	55556818	181591	7706754	181282
3781	181104	4177122	180726	5556508	180630	7714662	180559
3795	181121	4177124	180726	5882107	160308	7717686	160352
3796(2)	181128	4185217	180945	5927407	180631	7717886	160352
3797(2)	181119	4189508	180945	5946920	160427	7726125	160424
3801	181128	4220470	180726	5946923	160354	7735921	160433
3802	181129	4220471	180726	5946932	160354	7738223	180884
3817	181133	4235333	181001	5960017	180702	7739275	181591
3818	181133	4249594	180630	59635160	181584	7748867	181021
4029	181147	4263597	181001	5963889	180702	7750753	160354
4030	181148	4276954	180804	5972332	180875	7750754	160353
4037	181160	4298311	180630	5973754	160426	7777960	150354
4038	181150	4304418	180631	5979027	160197	7798691	150354
4051	181182	4305685	180631	5990986	160424	82205408	180704
4052	181179	4318331	181001	5992746	181021	82224358	180704
4053	181172	4320622	160308	60504288	150055	82304822	180726
4057	181194	4320627	160308	60518322	070054	82308678	070053
4060	181191	4334613	180945	60522876	160352	82345473	181584
4065	181201	4340878	181001	60534316	160353	82369531	150058
4066	181212	43423043	160435	60546091	070053	9150242380	180950
4074	181184	4345643	180726	605581530	150379	91514733	181152
4082	181219	4345645	180726	60562702	150387	9154067280	180421
4107	181156	4349082	180804	60581530	150379	9601810880	181201
4112	181197	4379249	160327	60590028	150055	9601811080	181194
4117	181202	4384184	150395	60590029	150055	9601842280	180937
4212	181183	4384372	160327	60593844	180689	9603324880	181373
		4407984	180804	60593845	180689	9603893880	180317
		4409505	180804	60733358	181584	9606177280	181358
		4414583	180630	60755012	150057	9606816880	150343
		4414599	180630	60755094	150057	9609352480	181194
		4414600	180804	60779188	070054	9612358180	160629
		4414779	180945	60800123	160354	961595948	160434
		4419628	150058	60808043	180317	9617220680	180317
		4421193	070053	60808142	180875	9619403780	180785
		4422049	180630	60808371	180689	9619403980	181358
		4429209	070053	60808979	160197	9621000680	181373
		4430291	181584	60809477	150379	9625299980	180317
		4431182	180631	60809606	150252	9629968880	181076
		4448131	180804	6081037	070053	9633001580	150506
		4459907	180630	60811067	180559	975301258	150055
		4460210	070053	60814715	181395	9753182280	150057
		4460464	070053	60814769	150451	9753293180	150055
		4460646	070053	60814852	181495	98424793	180875
		4473333	180631	60816137	181494	9939788	150148
		46410523	181179	6081644	181494	9940095	150088
		46414088	160433	631331116	180790	9941231	150148
		46423043	160435	633331115	180649	9941693	150148
		46428175	160426	634362106	180805	9942040	150176
		46434552	181589	6553310200	180638	99455420	181395
		46438456	160464	655331172	181001	9946862	180317
		46443793	160197	6553621201	180832	9947132	180317
		46447503	181495	717359980	181495	99488730	160671
		46452813	181589	71739275	181591	PRT03/02	180559
		46469917	181495	73502602	150176	PRT03/04	180559
		46531222	180559	75491289	181156	TGE422L	160671
		46533308	181495	7554136	070054		
		46541253	181495	7576067	160353		
		46543562	150246	7586250	181055	FORD	
		46548037	150246	7588520	181179	0409160	180636
		46559804	181494	7588802	180804	1000469	180485
		4655982	181494	7588847	180945	1008464	150516
		46784582	181495	7588881	180961	1025958	181590
		46806128	150451	7588882	180804	1027970	180636
		4792112	160424	7588920	180945	1035595	181592
		4850371	180841	75896560	160426	1044350	180757
		4859914	180689	7597693	070054	10533108	181590
		4998770	180631	7615564	181179	1062670	180796
		500312468	180689	7617640	160427	1067601	150416
		500382599	181395	7618893	160376	1070613	181369
		51774422	181590	7626232	150246	1075786	150416
		5428649	180630	7628059	160353	1100619	181400
		5430044	180950	7635535	070053	1113382	181590
		5494830	180810	7637025	180317	1119746	181456
						1119830	180796

ACCESSORIES

O. E. M names and numbers are used for reference purposes only

OE No.	HC-CARGO	OE No.	HC-CARGO	OE No.	HC-CARGO	OE No.	HC-CARGO
FORD continued							
1124770	181400	6143688	160416	83BB12A199B3A	150067	95VW9278CA	180688
1130402	150416	6145143	180871	83BB6M092BA	160416	96BB 9F472 BA	181590
1133441	181590	6145938	160350	83BB6M092AA	160416	96BB 9F472 BB	181590
1147420	181590	6146107	181065	83GB88607A2B	181008	96BB 9F472 AA	181590
1148070	181591	6146110	181065	83GB88607A2B	181008	97FB10884AA	180893
1213353	181456	6153090	150168	83SF12K059AA	150065	988F12029AB	150416
1317972	150416	6153380	150072	84FB6M092BA	160418	988F12029AC	150416
1414897	180636	6153451	150057	84FB6M092CA	160418	988F12029AD	150416
1471423	181590	6153469	160535	84FB6M092CB	160418	988F12029BA	150416
1473323	150395	6154134	181119	84SF12K057AA	150072	98AB 9F472 BB	181590
1474549	150395	6158319	070055	84SF12K059AA	150072	98FB9278AA	180636
1486937	150395	6159437	150057	84SF12K067BA	150057	98VW12A223AA	150406
1527105	181591	6160195	171162	85AB8B607A2A	181065	98W13480AA	181369
1583836	180820	6161570	160350	85AB8B607A2B	181065	9968969	160647
1610486	181147	6163243	180652	85AB8B607A3A	181065	A710X12K018E2	150395
1610487	181147	6165570	070055	85AB8B607A3B	181065	A790X12K018CA	150395
1629456	150077	6165571	070055	85AG9P704AA	160350	B3124Q03A	150068
1630263	160418	6168439	181065	85BB9350AA	070055	C3TZ12029A	150395
1630363	160418	6169111	181065	85GB88607B1A	181070	C5EH10884B	180812
1637546	150165	6169112	181065	85GB9350BA	070055	C6AH12171A	150395
1646357	180645	6169113	181065	85GB9350AA	070055	D0HZ9278A	180636
1646398	181065	6169693	181589	85GG9P704AA	160350	D1FZ10884B	180812
1647828	180636	6170902	180636	86AB9278BA	180636	D2Z710884A	180811
1648138	180558	6171402	160418	86AB9278BB	180636	D8EE9F472AA	181584
1649067	150281	6186463	181070	86BB9350AA	070055	D8FZ9F472A	181584
1652164	181147	6186464	181070	86BF12K062AA	150057	D9AE9F472AB	181584
1652479	160419	6190785	181128	86FB12A297AA	150168	D9AE9F472AA	181584
1652613	160535	6190786	181128	86GB9278AB	180645	D9EE 9F472 AB	181584
1652990	181070	6193368	180893	86GB9350BA	070055	D9EE 9F472 AA	181584
1669948	180883	6194291	160419	86VB10884BA	180871	D9EE9F472AB	181584
1669949	180848	6198827	180954	86VB17K624AA	160535	D9EE9F472AA	181584
1669963	180694	6213125	180636	87AB 9F472 AA	181589	D9FZ 9F472 A	181584
1669964	180688	6496665	181065	87AB17K624AC	160535	D9FZ9F472A	181584
1669965	180861	6499475	180636	87AB9F472AA	181589	E0DE9F472AA	181584
1677293	181590	6503279	150281	87BB88607AB	181119	E0FZ9F472B	181584
1701341	180812	6503280	150281	87BB88607AB	181119	E0ZE9F472AA	181584
19017170	150417	6513125	180636	87BB88607AA	181119	E17Z12A199A	150068
1953653	180657	6539671	180636	87GB 9F472 BA	181585	E1AF 9F472 AA	181584
1953654	180657	6539971	180636	88BG8B658AA	160416	E1AF9F472AA	181584
1953659	180755	6590140	180953	88SF12029A1A	150281	E1AZ 9F472 A	181584
1958438	160197	6590141	180954	88SF12029A2A	150281	E1AZ9F472A	181584
1F539F472BA	181589	6602998	150442	89BB88607AC	181141	E1SE9F472AA	181584
1F5Z9F472BA	181589	6696033	171162	89BB88607AC	181141	E1SF9F472AA	181584
1L2T14A464TA	192902	6703036	180652	89BB88607DA	181128	E2FS12A297B	150061
1M2115520AA	181456	6716335	180636	89EB8B607AA	181065	E2FZ12A297A	150064
1S6A9 G444 BA	181590	6740816	150442	89FB6M092AA	160419	E3BF9F472AA	181584
1S7F9 G444 BB	181590	6756611	160418	89FB8B607A1A	181065	E3EF 9F472 BA	181584
1S7T13480AA	180796	6756612	160419	89FB8B607AA	181065	E3EF 9F472 AA	181584
2S6A9 F472 BB	181590	68477572	160419	90BB6M092BA	160419	E3EF12A297A1A	150077
2S6A9 G444 BA	181591	6859705	150442	90BB6M092BB	160419	E3EF12A297A2A	150077
2S6A9G444BA	181591	6860288	150394	90BB6M092CA	160419	E3EF9F472BA	181584
3043998	150491	7001604	181070	90BB6M092AA	160419	E3EF9F472AA	181584
3240239	180630	7001605	181119	90GB108843AA	180636	E3FBA	180558
3248349	180630	7001606	181141	90GB10B843AA	180953	E3FZ 9F472 A	181584
3600688	180641	7001608	181065	91AB10884AA	180893	E3FZ9F472A	181584
3802334	181590	7001611	181070	91AB8B607A1A	180893	E3TF9F479BA	180558
3898281	181585	7003178	160535	928F6C315A1F	150442	E3TF9F479AA	180558
3914864	181590	7029401	180796	92AB8B607AA	181070	E3TZ 9F472 B	181584
3M2112B529AA	181491	7072695	180884	92BB9278AA	181070	E3TZ9F472B	181584
4337456	181411	7158126	181411	92VW8502AA	070192	E3TZ9F479A	180558
4L3A9G444AA	181591	7188531	160550	93AB 9F472 CA	181590	E3ZF12A644A1A	180558
4L3Z9G444AA	181591	7188532	160550	93BB13480BB	180796	E3ZF12A644A2A	180558
5006104	150395	71BG15520EA	181147	93BB13480BC	180796	E3ZF12A644B1A	180558
5S65 9F472 AA	181591	71BG15520FA	181147	93BB6M092BA	160469	E43F9F479A1A	180558
5S659F472AA	181591	71HM12024AA	150395	93BB6M092AA	160469	E43F9F479A2A	180558
6005474	181147	7210731	180995	948F6C315AA	150442	E43F9F479B1A	180558
6033136	181147	7215734	180757	94BB 9F472 BB	181590	E43F9F479B2A	180558
6058836	180820	76BG15520A	181147	94BB 9F472 DA	181590	E43Z 9F472 A	181584
6080608	180636	76BG15520A/B	181147	95NW18456BB	160550	E43Z12297A	150077
6086163	180636	76BG15520AB	181147	95NW18456CB	160550	E43Z12A297A	150077
6086506	150065	76BG15520AIB	181147	95VW10884BA	180848	E43Z9F472A	181584
6090246	180652	76BG15520B	181147	95VW10884AA	180883	E43Z9F479A	180558
6098273	180812	76BG15520AA	181147	95VW12029AA	150516	E43Z9F479B	180558
6107322	160348	77FB10884AA	180820	95VW12A648BA	180861	E43ZP12A297A	150077
6109051	150067	81AB9278BA	180636	95VW13480BB	180757	E43ZP12Z297A	150077
6120663	181008	81AB9278AA	180636	95VW13480AA	180757	E47F 9F472 AA	181584
6127983	070055	81AE9278BA	180636	95VW8502BA	070192	E47F9F472AA	181584
6127985	070055	81SF12K059AB	150065	95VW8502AA	070192	E47F9F47AA	181584
6132248	160418	81SF12K059BA	150065	95VW88607DA	180995	E4ZF12A644AA	180558
6135656	150065	81SF12K059AA	150065	95VW88607DA	180995	E53F9F472AA	181584
6142676	181070	82GG9P704AA	160348	95VW9278BA	180694	E53Z 9F472 B	181584

OE No.	HC-CARGO	OE No.	HC-CARGO	OE No.	HC-CARGO	OE No.	HC-CARGO
E53Z9F472B	181584	E7SF 9F472 BA	181585	F4SF 9F472 AB	181590	F8XZ9F472CA	181589
E57F9F479A1A	180558	E7SF 9F472 CA	181585	F4SF 9F472 DA	181590	FB006M092BA	160418
E57F9F479A2A	180558	E7SF 9F472 AA	181585	F4SZ 9F472 A	181590	FB006M092CB	160418
E5FZ9F479A	180558	E7TE 9F472 DA	181585	F4SZ 9F472 D	181590	FOZ2 9F472 C	181584
E5RF12297BA	150077	E7TE 9F472 EA	181585	F4ZF 9F472 A	181590	FOZ29F472A	181584
E5RF12A297BA	150077	E7TF 9F472 CA	181585	F4ZF 9F472 AB	181590	FOZ29F472B	181584
E5SF9F479A1A	180558	E7TF 9F472 DA	181585	F4ZF 9F472 BB	181590	FOZ29F472C	181584
E5SZ9F479A	180558	E7TF 9F472 EA	181585	F4ZZ 9F472 A	181590	FOZ29F472AA	181584
E63F 9F472 AB	181584	E7TZ 9F472 B	181585	F4ZZ 9F472 AB	181590	FOBZ 9F472 B	181584
E63F 9F472 BA	181584	E7TZ 9F472 E	181585	F4ZZ 9F472 B	181590	FOBZ9F472B	181584
E63F 9F472 AA	181584	E8BF12A644AA	180558	F5AF 9G444 AB	181590	FOJY 9F472 B	181584
E63F9F472AB	181584	E8BZ 9F472 A	181584	F5AF 9G444 BB	181590	FOJY9F472B	181584
E63F9F472BA	181584	E8BZ12A297A	150417	F5AF12A648AA	181411	FOSZ 9F472B	181585
E63F9F472AA	181584	E8BZ12A644A	180558	F5AZ 9G444 A	181590	FOTZ 9F472E	181585
E63Z 9F472 A	181584	E8BZ212A297A	150160	F5AZ 9G444 B	181590	JE50 18861 A	181590
E63Z9F472A	181584	E8BZ9472A	181584	F5CZ 9F472 A	181590	KLA6 18861	181590
E67F9F479A1A	180558	E8DZ12A297A	150168	F5MF 9F472 A2A	181590	V85AB9P704AA	160354
E67F9F479A2A	180558	E8EF12A644AA	180558	F5MF 9F472 B1B	181592	XF 251 432	181584
E6DF 9F472 A1A	181584	E8FZ12A297A	150077	F5MF 9F472 B2B	181592	XF251432	181584
E6DF 9F472 B1A	181584	E8FZ12A644A	180558	F5MF 9F472 BA	181592	XF529F472HA	181589
E6DF9F472A1A	181584	E8GV12029B	150275	F5MF 9F472 BB	181592	XF529F472HB	181589
E6DF9F472B1A	181584	E8GY 9F472 A	181584	F5MF 9F472 DB	181592	XF529G444CA	181589
E6DF9F472AA	181584	E8GY9F472A	181584	F5MF 9F472 DC	181592	XF529F472GA	181589
E6DZ 9F472 A	181584	E8GY9F472F	181584	F5MF 9F472 AA	181590	XF529F472HA	181589
E6DZ 9F472 B	181584	E8TZ 9F472B	181585	F5MZ 9F472 B	181591	XF529F472HB	181589
E6DZ9F472A	181584	E8TZ12029A	150281	F5MZ 9F472 DB	181592	XF529G444CA	181589
E6DZ9F472B	181584	E9Z212029B	150275	F5MZ 9F472 AA	181590	XL3F 9F472 AA	181591
E6EF12A297AA	150077	E9Z212A297A	150160	F5MZ9F472B	181591	XL3F9F472BA	181591
E6EF12A644A1A	180558	E9Z29F472A	181584	F5RZ 9F472 B	181590	XL3F9F472CA	181591
E6EF12A644A2A	180558	E93F 9F472 CA	181585	F5RZ 9F472 D	181590	XL3F9F472DA	181591
E6EF12A644AA	180558	E93F 9F472BA	181585	F5RZ 9F472 AA	181590	XL3F9F472AA	181591
E6EF9F479A1A	180558	E97F 9F472 BA	181585	F5RZ13480A	180796	XL3Z 9F472 BA	181592
E6EF9F479A2A	180558	E97F 9F472 CA	181585	F5WF 9F472 BA	181590	XL3Z 9F472 AA	181592
E6FZ9F479A	180558	E97F 9F472 DA	181585	F5WZ 9F472 BA	181590	XL3Z9F472BAFC	181591
E6PF9F479A1A	180558	E9BZ 9F472 A	181584	F62Z 9F472 BB	181590	XL3Z9F472C	181591
E6PF9F479AA	180558	E9BZ9F472A	181584	F62Z 9F472 DD	181590	XL3Z9F472D	181591
E6SF12A297A1A	150077	E9RF12A297AA	150077	F62Z 9F472 FF	181590	XM218A570BA	181400
E6SF12A297A2A	150077	E9RZ12A297A	150077	F62Z 9F472 GG	181590	XS4P7H103AB	150491
E6SZ 9F472 A	181584	E9SF 9F472 BA	181585	F62Z9F472EE	181589	YS6A 9F472 AC	181590
E6SZ12A297A	150077	E9SF 9F472 CA	181585	F62Z9F472AA	181589	Z590141	180954
E6SZ9F472A	181584	E9ZZ12A297A	150160	F6C6 9F472 AA	181590		
E6TZ9F479A	180558	EDY4	150067	F6CF 9G444 BA	181590	GE LIGHTING	
E6ZF 9F472 AB	181584	EDY7	150077	F6CF 9G444 CA	181590	1157	170724
E6ZF 9F472 BA	181584	EODE 9F472 AA	181584	F6CF 9G444 DA	181590	2357NA	170709
E6ZF9F472AB	181584	EODE9F472AA	181584	F6CF 9G444 DB	181590	3057NA	170711
E6ZF9F472AC	181584	EOFZ 9F472 B	181584	F6CF 9G444 DC	181590	3157	170710
E6ZF9F472BA	181584	EOFZ9F472B	181584	F6CZ 9F472 AA	181590	886	170951
E6ZF9F472CA	181584	ESRF12A297BA	150077	F6CZ 9G444 BA	181590	886	171953
E6ZF9F472AA	181584	F0212A297A	150160	F6CZ 9G444 DA	181590	894	170726
E6ZZ 9F472 A	181584	F02Z 9F472 A	181584	F6CZ 9G444 DB	181590	9004	170692
E6ZZ 9F472 B	181584	F02Z 9F472 B	181584	F6DF 9G444 B2A	181590	9005	170693
E6ZZ9F472A	181584	F02Z 9F472 C	181584	F6DF 9G444 BA	181590	9006	170694
E6ZZ9F472B	181584	F02Z12A297A	150160	F6DF 9G444 E1A	181590		
E70Z9F479A	180558	F02Z9 F472 AA	181584	F6DF 9G444 E2A	181590	GENERAL MOTOR	
E73F 9F472 BA	181585	F02Z9F472A	181584	F6DF 9G444 EA	181590	01985703	150064
E73F 9F472 CA	181585	F02Z9F472B	181584	F6DF 9G444 AA	181590	03439088	180808
E73F 9F472 AA	181585	F02Z9F472C	181584	F6DZ 9G444 B	181590	03474200	150217
E73Z 9F472 A	181585	F02Z9F472AA	181584	F6DZ 9G444 CA	181590	03474232	150187
E73Z 9F472 B	181585	F0BZ12A297A	150371	F6DZ 9G444 CA	181590	03474233	150196
E73Z 9F472 BA	181585	F0BZ9F472B	181584	F6DZ 9G444 E2A	181590	03474282	150187
E73Z9F472C	181591	F0BZ9F472C	181584	F6DZ 9G444 EA	181590	08954566	180630
E7DF9F479A1A	180558	F0C69F472EB	181584	F6DZ 9G444 AA	181590	090040992	160416
E7DF9F479A2A	180558	FOJY12A297B	150417	F6MF 9F472 AA	181590	090228928	160416
E7DZ12A297A	150168	FOJY9F472A	181584	F6MF 9F72 AA	181590	090341822	160416
E7DZ9F479A	180558	FOJY9F472B	181584	F6MZ 9F472 AA	181590	09110560	150404
E7EE12A644A1A	180558	F0SZ 9F472 B	181585	F6RZ 9F472 AA	181590	10456576	150491
E7EE12A644A2A	180558	F0TZ 9F472 E	181585	F6XA 9F472 BA	181590	10457075	150403
E7EE9F479A1A	180558	F1CF9F472A	181584	F6XA 9F472 CA	181590	10469931	150239
E7EE9F479A2A	180558	F1CZ 9F472 A	181584	F6XA 9F472 CB	181590	10482823	150062
E7EF12A644A1A	180558	F1CZ9F472A	181584	F6XA 9G444 AA	181590	10482824	150063
E7EF12A644A27	180558	F1SF12A297C1A	150168	F6XZ 9F472 CA	181590	10482825	150064
E7EF12A644A2A	180558	F1SF12A297C2A	150168	F6ZF 9G444 AA	181590	10496048	150239
E7EF9F479A1A	180558	F1UF 9F472 AA	181590	F6ZZ 9G444 AA	181590	10496541	150239
E7EF9F479A27	180558	F3XA12029AA	150273	F72Z 9F472 GG	181590	10498042	150061
E7EF9F479A2A	180558	F3XY12A297A	150221	F7XA 9F472 CA	181590	1103872	150403
E7EF9F479AA	180558	F3XY12K072A	150221	F7XA 9F472 FB	181590	1103905	150403
E7FZ12A644A	180558	F4AF 9F472 A	181590	F7XA 9F472 FC	181590	1115033	150395
E7FZ12A644A4A	180558	F4AZ 9F472 A	181590	F7XZ 9F472 FA	181590	1115043	150395
E7FZ9F479A4A	180558	F4BZ 9F472 A	181584	F7XZ 9F472 FB	181590	1115062	150395
E7RY 9F472 A	181585	F4BZ9F472A	181584	F8CZ 9F472 BB	181590	1115066	150395
E7RZ12A297A	150077	F4FF12A297AA	150168	F8RZ 9G444 BB	181590		

OE No.	HC-CARGO	OE No.	HC-CARGO	OE No.	HC-CARGO	OE No.	HC-CARGO
GENERAL MOTOR continued							
12569240	180557	90541520	181395	2PS006717-031	170884	4DM003460-027	160314
16010892	150063	90541937	181395	2PS006717-061	170885	4DM003640-051	160305
16015130	150061	90542063	181395	2SA001259-651	171181	4DM003640-052	160305
16017433	150062	90543059	150524	2SA001259-751	171181	4DM003944-041	160262
16017460	180557	9109810	180905	2SA003057-021	171173	4DN003438-007	160263
16137039	180557	91112377	180641	2SA006717-001	170886	4DN003438-011	160263
16139379	150239	91167210	160795	2SA997027-001	171331	4DN003438-047	160263
16139869	150061	9118368	150468	2SD001685-211	171195	4DN003438-067	160263
16139889	150063	9119567	150525	2SD001685-231	171195	4DN003438-127	160263
16140039	150239	91298691	181395	2SD001685-341	171195	4DW003944-051	160199
16140049	150063	9174621	150485	2SD001685-341	171329	4RA003437-041	160239
16158829	150063	9193149	181494	2SD001688-141	170893	4RA003437-047	160239
16410049	150063	9193533	181495	2SD001688-171	170895	4RA003437-051	160240
17112715	180557	9195729	181495	2SD001699-061	171189	4RA003437-057	160240
18140189	150061	9201425	181495	2SD001699-071	171190	4RA003510-081	160083
19005212	150521	9201699	160795	2SD001699-511	171190	4RA003510-111	160282
1977907	150061	9204425	181495	2SD002578-011	171191	4RA003510-157	160307
1977958	150063	9227760	181494	2SD003167-011	171201	4RA003510-267	160265
1978432	150063	93171335	181495	2SD003167-021	171199	4RA007782-011	160363
1978617	150061	93171527	181491	2SD003184-031	171203	4RD001838-011	160081
1979107	150063	93171627	181491	2SD003184-041	171204	4RD001838-021	160216
1979571	150063	93171760	181495	2SE001679-071	171188	4RD003520-031	160308
1985342	150063	9389131	180557	2SE001685-201	171194	4RD003520-071	160337
1985703	150064	94024702	181185	2SE001685-221	171194	4RD003520-081	160081
1987744	150061	94113439	181185	2SE001685-331	171194	4RD003520-091	160216
1997907	150061	94118754	180755	2SE001685-331	171328	4RD003520-131	160308
24414665	181495	94149427	181185	2SE001699-071	171188	4RD007783-011	160365
24437502	181491	94205866	180875	2SE002578-001	171191	4RD007794-021	160403
3474200	150217	94243344	150091	2SE002578-701	171191	4RD007794-031	160403
3474233	150196	94362930	180755	2SE003167-021	171199	4RP008189-001	160348
836590	181494	94404544	150157	2SE003184-011	171203	4RP008189-021	160350
836591	181494	94464566	181185	2SE003184-101	171204	4RP008189-031	160352
836592	181494	94472002	180808	2SE997111-011	171203	4RP008189-041	160352
8954566	180630	96052138	180641	2SE997111-021	171204	4RP008189-051	160295
90006145	150056	96053621	180641	2SE998530-001	171202	4RP008189-061	160372
90006499(2)	150098	96056758	180914	2SK005883-011	170913	4RP008189-071	160373
90006964	150098	97113439	181185	2SK005883-021	170913	4RP008189-081	160374
90008145	150056	97138635	181185	2SL003567-691	171206	4RP008189-091	160375
90056698	150056	D513	150395	2SL005883-031	170912	4RP008189-111	160353
90069100	181150	U501	150395	2TF001259-661	171197	4RP008189-121	160354
90069864	160297	HANOMAG		2TF001259-761	171197	4RV008188-001	160441
90080939	180875	TPD1212	160423	2TJ003168-051	171196	4RV008188-011	160442
90124673	160352	TPFF612	160419	2TJ781000-001	170668	4RV008188-021	160443
90140187	150056	HELLA		2TJ801000-001	170640	4RV008188-031	160444
90158189	160352	1A3002850-031	170868	2TM006717-047	170886	4RV008188-041	160445
90158443	160352	1A3996026-011	171038	2VD007323-031	170916	4RV008188-051	160446
90187341	150056	1GA006876-001	171168	2VD007323-041	170917	4RV008188-061	160447
90213542	160352	1GA006991-001	170851	2VD007323-131	170922	4RV008188-071	160448
90225811	160295	1GA006991-031	170853	2VD007323-141	170923	4RV008188-081	160423
90230894	160295	1GA006991-041	170851	2VD007500-091	171447	4RV008188-091	160424
90240698	160295	1GA006991-044	170851	2VP003567-127	171205	4RV008188-101	160425
90240811	160295	1GA007506-011	170857	2VP007323-001	170913	4RV008188-111	160426
90243630	150380	1GA007506-091	170857	2VP007323-021	170917	4RV008188-121	160427
90245033	181182	1GA998532-011	170859	2VP007323-121	170923	4RV008188-141	160429
90246852	180808	1AA004109-041	170867	2XS005639-001	171196	4RV008188-151	160430
90276101	160416	2BE001259-061	171215	2ZR001389-101	171224	4RV008188-161	160416
90295498	150055	2BE003014-251	170925	2ZR001423-001	170934	4RV008188-171	160420
90295499	150055	2BE003184-051	171217	2ZR002985-081	170935	4RV008188-181	160421
90297486	150173	2BE003184-061	171218	2ZR002985-264	170935	4RV008188-181	160421
90297786	150173	2BE998530-011	171216	2ZR003315-041	170932	4RV008188-201	160417
90323839	180317	2KA001386-281	170936	2ZR997033-011	171222	4RV008188-211	160418
90337100	181202	2KA001389-101	171166	4DB001887-001	160243	4RV008188-221	160419
90341822	160416	2KA001389-101	171224	4DB001887-002	160243	4RV008188-241	160438
90355880	181129	2KA003389-061	171225	4DB001887-021	160243	4RV008188-251	160439
90360314	150380	2KA003389-067	171225	4DB001887-022	160243	4RV008188-271	160431
90378651	160295	2KA997011-021	171224	4DB002478-171	160242	4RV008188-281	160432
90410792	180875	2NE001412-091	170930	4DB002895-011	160242	4RV008188-291	160433
90414405	150055	2NE001423-011	170929	4DB002895-012	160242	4RV008188-301	160434
90423761	181495	2NE003315-011	170928	4DB003675-001	160261	4RV008188-311	160435
90449435	181088	2PF001259-631	171182	4DB003750-071	160242	4RV008188-321	160436
90449739	150196	2PF001638-011	170875	4DB003750-151	160242	5DA006623-001	150055
90458453	180801	2PG003057-011	171174	4DB004124-002	160341	5DA006623-011	150056
90482454	181182	2PG003057-061	171174	4DB004225-001	160305	5DA006623-021	150074
90487859	180884	2PG003057-067	171174	4DB004225-002	160305	5DA006623-031	150075
90504499	180753	2PG006717-021	170887	4DD006716-011	160791	5DA006623-041	150057
90506103	150485	2PS003057-051	171175	4DM001861-181	160262	5DA006623-051	150058
90510183	180875			4DM003360-001	160244	5DA006623-061	150062
90510386	150196			4DM003360-002	160244	5DA006623-071	150064
90528435	181495			4DM003360-002	160244	5DA006623-151	150068
90534902	181341			4DM003390-011	160244	5DA006623-161	150088
90536194	150525			4DM003460-021	160314	5DA006623-171	150071

OE No.	HC-CARGO	OE No.	HC-CARGO	OE No.	HC-CARGO	OE No.	HC-CARGO
5DA006623-181	150154	9EL118701-001	171259	36531-P0A-A11	181591	36531-PE2-905	181584
5DA006623-231	150232	9EL121431-001	171259	36531-P0B-A01	181591	36531-PE2-906	181584
5DA006623-241	150072	9EL122689-027	171263	36531-P12-A02	181591	36531-PE7-662	181584
5DA006623-251	150175	9EL135266-001	171244	36531-P12-A03	181591	36531-PE7-663	181584
5DA006623-261	150067	9EL146451-001	171236	36531-P12-A12	181591	36531-PEA-J01	181591
5DA006623-281	150176	9EL786000-001	170641	36531-P1A-004	181584	36531-PFB-J02	181591
5DA006623-291	150221	9EL787000-001	170642	36531-P1E-J01	181591	36531-PFC-003	181584
5DA006623-311	150077	9EL997451-001	171258	36531-P1K-E01	181584	36531-PFD-003	181584
5DA006623-331	150381	9EL997452-001	171259	36531-P1K-E11	181591	36531-PFE-J02	181584
5DA006623-351	150092	9EL998002-001	171253	36531-P1R-004	181592	36531-PFE-N03	181591
5DA006623-371	150157	9ES106588-001	171250	36531-P1R-A01	181590	36531-PG7-305	181584
5DA006623-381	150091	9XD997909-801	171266	36531-P1R-A02	181590	36531-PG7-315	181584
5DA006623-391	150097	9XX009122-001	160548	36531-P2A-J01	181584	36531-PG7-661	181584
5DA006623-401	150236	9XX009122-011	160549	36531-P2A-J02	181584	36531-PG7-A01	181584
5DA006623-411	150096			36531-P2P-A01	181590	36531-PGE-A11	181590
5DA006623-421	150160	HITACHI		36531-P2Y-G01	181584	36531-PGK-A03	181590
5DA006623-431	150165	32120-PA0-664	150091	36531-P3F-004	181591	36531-PGM-003	181591
5DA006623-461	150215	A128-0A	150079	36531-P3F-014	181591	36531-PGM-J51	181591
5DA006623-471	150384	C6R800	150395	36531-P3F-902	181591	36531-PH2-004	181584
5DA006623-481	150234	CM11209B	150272	36531-P3Y-G01	181584	36531-PH2-014	181584
5DA006623-491	150378	CM11217	150272	36531-P3Y-G02	181584	36531-PH2-024	181584
5DA006623-501	150371	CM1T-204B	150381	36531-P45-G01	181591	36531-PH3-003	181584
5DA006623-511	150377	CM1T-204E	150381	36531-P45-G02	181591	36531-PH3-013	181584
5DA006623-531	150171	CMT204F	150381	36531-P5A-003	181590	36531-PH4-661	181584
5DA006623-541	150172	DIS405	150409	36531-P5A-A01	181591	36531-PH4-662	181584
5DA006623-561	150173	DIS408	150406	36531-P5G-003	181590	36531-PH4-663	181584
5DA006623-571	150061	E12-117	150398	36531-P5K-003	181591	36531-PH4-664	181584
5DA006623-581	150063	E123-02	150384	36531-P5M-004	181591	36531-PH4-682	181584
5DA006623-591	150409	E123-03	150384	36531-P5M-014	181591	36531-PH5-004	181584
5DA006623-601	150379	E126-1	150091	36531-P5P-004	181591	36531-PH7-003	181584
5DA006623-611	150387	E128-0	150079	36531-P5P-014	181591	36531-PH7-013	181584
5DA006623-621	150227	L130-5046	150092	36531-P64-004	181584	36531-PH7-305	181584
5DA006623-661	150065	RS12-0A	150360	36531-P64-901	181584	36531-PH7-315	181584
5DA006623-691	150225			36531-P64-902	181584	36531-PH7-732	181584
5DA006623-701	150231	HKT		36531-P6W-A01	181590	36531-PJ0-661	181584
5DA006623-711	150228	CP-71	100325	36531-P72-A01	181591	36531-PJ0-L01	181584
5DA006623-731	150380			36531-P75-A01	181591	36531-PJ0-L02	181584
5DA006623-781	150235	HONDA		36531-P7A-003	181584	36531-PJ0-L03	181584
8EW009100-201	160550	06302-PT2-000	150236	36531-P7J-004	181591	36531-PK1-004	181584
8EW009100-301	160515	06302-PT2-A00	150236	36531-P8A-A01	181591	36531-PK1-014	181584
8EW009100-311	160520	06302-PT3-000	150236	36531-P8C-A01	181591	36531-PK2-003	181584
8EW009100-461	160513	06302-PT3-000	150236	36531-P8C-A11	181590	36531-PK2-004	181584
8EW009143-401	160528	06302-PTA-00	150236	36531-P8C-A21	181590	36531-PK2-013	181584
8HG002240-001	171226	16400-PDD-X00	181495	36531-P8D-J21	181590	36531-PK2-L01	181584
8JA001909-001	170964	30120-PA0-661	150091	36531-P8E-A01	181591	36531-PK3-A02	181591
8JA001920-001	180403	30120-PA6-921	150097	36531-P8E-A11	181590	36531-PK3-A04	181591
8JA002263-001	180401	30120-PA9-21	150092	36531-P8F-A11	181590	36531-PL1-013	181584
8JA003525-001	190766	30120-PB1-006	150097	36531-P9L-E02	181590	36531-PL2-003	181584
8JA005951-051	180330	30120-PH4-005	150091	36531-PBC-A01	181591	36531-PL2-013	181584
8JA103500-001	180332	30120-PH7-006	150097	36531-PBF-A11	181590	36531-PL2-023	181584
8JA715606-001	190767	30120-PJ7-006	150097	36531-PBY-003	181590	36531-PLM-A01	181591
8JB001933-001	180402	30120-PM3-0050	150398	36531-PBY-J01	181590	36531-PLR-A01	181590
8JB001944-001	180404	30120-PM5-A01	150236	36531-PC7-661	181584	36531-PM3-004	181584
8JB102100-001	180329	30120-PMA-01	150236	36531-PC7-662	181584	36531-PM4-014	181584
8KV002142-031	191507	30120-PR3-003	150236	36531-PC7-663	181584	36531-PM5-A01	181584
8KV002143-031	191508	30120-PT3-003	150236	36531-PC7-664	181584	36531-PM5-L01	181584
8PD003798-001	210212	30120-PT3-004	150236	36531-PC7-665	181584	36531-PM5-L02	181584
8RA002014-031	170165	30130-P06-006	150384	36531-PC7-682	181584	36531-PM8-305	181584
8RA002014-041	170170	30130-P54-006	150236	36531-PCA-004	181591	36531-PM8-A01	181584
8RA002014-051	170169	30130-P06-006	150384	36531-PCA-014	181591	36531-PM8-A03	181584
8RA002020-001	170163	30500-634-005	150395	36531-PCC-004	181591	36531-PMS-A01	181591
8RA002023-021	171233	30500-PM3-005	150272	36531-PCC-014	181591	36531-PN4-J03	181584
8RA002023-21	171233	30500-PM3-015	150272	36531-PCX-000	181590	36531-PN4-N02	181584
8RA003326-011	171230	30500-PM5-A02	150269	36531-PCX-004	181590	36531-PNB-014	181591
8TW004223-031	160197	30500-PM5-A03	150269	36531-PCX-014	181590	36531-PO5-A01	181584
8TW005206-031	160381	30500-PO1-005	150272	36531-PD2-305	181584	36531-PP0-014	181584
8TW005206-051	160382	30500-POI-005	150272	36531-PD2-661	181584	36531-PP0-N02	181584
8TW005496-0051	160198	30500-PT0-005	150272	36531-PD2-662	181584	36531-PR4-A01	181584
8TW006847-001	160535	30510-PT2-006	150270	36531-PD2-663	181584	36531-PR4-L02	181584
8TW006849-001	160386	30520-PDF-E01	150252	36531-PD2-664	181584	36531-PR7-003	181590
9DF112246-001	170620	32120-PA0-661	150091	36531-PD6-661	181584	36531-PR7-A01	181591
9DF112247-001	170621	36531-P01-004	181584	36531-PD6-662	181584	36531-PR7-A02	181591
9EL109048-001	171244	36531-P01-G01	181584	36531-PDE-E02	181590	36531-PR7-A11	181591
9EL112753-001	171236	36531-P01-G02	181584	36531-PDE-A01	181590	36531-PR7-J01	181591
9EL112758-001	171236	36531-P05-A01	181584	36531-PE1-305	181584	36531-PR7-J02	181591
9EL113324-001	171237	36531-P05-A02	181584	36531-PE1-662	181584	36531-PT0-014	181584
9EL113324-041	171237	36531-P06-A01	181584	36531-PE1-663	181584	36531-PT0-J03	181584
9EL117334-001	171242	36531-P06-A11	181591	36531-PE1-A02	181584	36531-PT0-N02	181584
9EL118445-001	171252	36531-P07-A01	181584	36531-PE2-902	181584	36531-PT2-J02	181590
9EL118697-001	171258	36531-P07-L01	181591	36531-PE2-903	181584	36531-PT3-A02	181591
9EL118700-001	171258	36531-P08-004	181584	36531-PE2-904	181584	36531-PT3-A04	181591

OE No.	HC-CARGO	OE No.	HC-CARGO	OE No.	HC-CARGO	OE No.	HC-CARGO
HONDA continued							
36531-PT3-A05	181591	36532-PMS-A01	181591	37750-611-154	180811	9-82513508-0	150395
36531-PT3-A12	181591	36532-PNA-004	181591	37750-PH2-014	180832	9-82513509-0	150395
36531-PV0-024	181591	36532-PNC-004	181591	37870-P5T-G00	180875	IVECO	
36531-PV0-J12	181591	36532-PND-A01	181590	37870-PJ7-003	180910	41118038	192902
36531-PV1-A02	181591	36532-PND-A11	181590	37870-PK2-005	180910	4171667	180805
36531-PVF-A01	181590	36532-PND-A21	181590	37870-PK2-015	180910	4448131	180804
36531-PWA-902	181591	36532-PPA-004	181590	37870-PLZ-D00	181395	504051082	181495
36531-PWA-903	181591	36532-PPA-A01	181590	79310-SR3-A01	160528	5946923	160354
36531-PXH-013	181591	36532-PR7-003	181590	87870-PK2-005	180910	5963516	181584
36531-PY3-003	181590	36532-PR7-A01	181591	89702-425-60	181590	751874	160337
36531-PYD-901	181591	36532-PR7-A02	181591	89728-735-20	181591	7648798	150379
36531-PZ3-N02	181584	36532-PR7-A11	181591	90007-ZE2-003	191545	764898	150379
36531-PZD-A01	181591	36532-PR7-J01	181591	AJF51-886-1A	181591	9462703	160424
36531-PZX-A01	181590	36532-PR7-J02	181591	ISKRA			
36531-PAA-305	181591	36532-PRB-A01	181590	AEV1401	150055	960099	160478
36531-PAA-A01	181591	36532-PRB-A11	181590	AEV140112	150055	975301258	150055
36531-PAA-A02	181591	36532-PSA-J01	181591	ISUZU			
36531-RDJ-A01	181591	36532-PWA-G01	181591	5-82440005-0	181185	99463242	170998
36531-RDM-A01	181591	36532-PWA-G02	181591	5-86202813-0	181590	99463243	171098
36531-RDM-A02	181591	36532-PWA-J02	181591	5-86202814-0	181591	99463244	170999
36531-RLC-J01	181591	36532-PY3-003	181591	5-86202837-0	180832	JAEGER	
36532-P0A-A01	181591	36532-PYC-J01	181591	5-86202847-0	180910	061199	180859
36532-P0G-A01	181591	36532-PYC-J12	181591	5-86205842-0	181590	078890	180810
36532-P0G-A02	181591	36532-PZA-A01	181590	5-86206251-0	181591	09477509	180950
36532-P13-A01	181591	36532-PZA-J01	181590	8-01979571-0	150063	31556605	181005
36532-P1E-A01	181591	36532-PZA-L02	181590	8-08990351-0	181584	326612	180810
36532-P1R-A01	181591	36532-PZD-A01	181590	8-08990741-0	181584	326979	180810
36532-P2E-A01	181591	36532-PZX-A01	181590	8-08990793-0	181585	333783	180645
36532-P2E-A51	181591	36532-PAA-A01	181591	8-08990793-0	181585	33540103	180937
36532-P2P-A01	181591	36532-PAA-A02	181591	8-10496541-0	150239	33640103	180937
36532-P2R-A01	181591	36532-PAA-L01	181591	8-12567127-0	181591	366407	180937
36532-P3F-A01	181591	36532-PAA-L02	181591	8-12567163-0	181591	JAGUAR	
36532-P3F-A11	181591	36532-PAA-L41	181590	8-12573167-0	181590	AGU 1108	181584
36532-P5A-003	181591	36532-RAD-L11	181590	8-12573168-0	181591	AGU 1870	181585
36532-P5A-A01	181591	36532-RAD-L12	181590	8-12573721-0	181590	C2C 25956	181590
36532-P5G-003	181591	36532-RCA-A01	181590	8-12577588-0	181591	C2C 7360	181590
36532-P5M-A01	181591	36532-RCA-A02	181590	8-12578624-0	181591	C2S 38497	181590
36532-P5M-A02	181591	36532-RCA-A51	181590	8-16017460	180557	CAC2263	070053
36532-P65-A00	181591	36532-RCJ-A01	181590	8-16137039	180557	CAC4269	070053
36532-P65-A003	181591	36532-RDJ-A01	181590	8-16140049	150063	CBC5657	070053
36532-P6W-A01	181591	36532-RFE-J02	181591	8-24576791-0	181584	DAC 2549	181584
36532-P72-A01	181590	36532-RFE-J52	181591	8-24577303-0	181591	DAC 6907	181585
36532-P73-A01	181590	36532-RGA-014	181591	8-25105107-0	181584	DBC 10744	181585
36532-P75-A01	181590	36532-RGA-J01	181591	8-25105901-0	181584	ERC 6193	181584
36532-P8A-A01	181591	36532-RJA-004	181590	8-25133185-0	181584	LNA1682AC	181591
36532-P8C-A01	181591	36532-RKC-014	181591	8-25162600-0	181584	LNE1682BB	181590
36532-P8C-A02	181591	36532-RMX-A01	181591	8-25162693-0	181584	LNE1682BC	181590
36532-P8C-L01	181591	36532-RNA-A01	181590	8-25162753-0	181584	ULC 1917	181584
36532-P8C-L02	181591	36532-RRA-004	181590	8-25166816-0	181584	XR8 1557	181590
36532-P8D-J01	181591	36532-RTA-004	181591	8-92196190	150395	XR8 2007	181590
36532-P8F-A01	181591	36532-RAA-A01	181590	8-94025866-0	180875	XR8 22998	181590
36532-P8F-A11	181591	36532-TEA-A01	181591	8-94118754-0	180755	XR8 6938	181590
36532-P8F-A11	181591	36535-P5A-A01	181591	8-94118754-1	180755	JAHN	
36532-PBF-A11	181590	36535-P5A-A51	181591	8-94149427-0	181185	1000	171133
36532-PBY-003	181590	36535-P5G-A01	181591	8-94208866-0	180875	1100	170804
36532-PBY-J01	181590	36541-PR7-A01	181591	8-94224731-0	150395	1101	170334
36532-PCX-A01	181591	36541-PR7-A31	181591	8-94235627-0	160407	1101	170804
36532-PDC-E01	181591	36542-PR7-A01	181591	8-94243344-0	150091	1101	170768
36532-PDE-E02	181591	36542-PR7-A51	181591	8-94362930-0	180755	1102	170348
36532-PDN-A01	181591	36542-RCA-A01	181590	8-94404544-0	150157	1102	170792
36532-PEA-A01	181591	36542-RCA-A01	181590	8-94404545-0	150267	1103	170360
36532-PEL-003	181591	36542-RDJ-A01	181590	8-94408151-0	181584	1104LL	170657
36532-PGK-A02	181591	36542-RJA-004	181590	8-94411336-0	181185	1104LL	171113
36532-PH7-003	181584	37240-534-671	180641	8-94411366-0	181185	1106	170692
36532-PH7-013	181584	37240-634-671	180641	8-94411366-1	181185	1107	170450
36532-PHM-A11	181591	37240-657-003	180638	8-94464566-0	181185	1107	171125
36532-PHM-A51	181590	37240-657-013	180638	8-94464866-0	181185	1108	170572
36532-PHX-G01	181591	37240-657-305	180638	8-97018586-0	181584	1109	170009
36532-PJO-661	181584	37240-P13-003	180638	8-97018587-0	181585	1109	171065
36532-PJO-L01	181584	37240-P13-004	180638	8-97024256-0	181590	1110	170802
36532-PJO-L02	181584	37240-P13-013	180638	8-97032102-1	181590	1111	170069
36532-PK2-003	181584	37240-P13-014	180638	8-97062292-0	181585	1111	170332
36532-PK2-L01	181584	37240-PA6-004	180638	8-97113439-0	181185	1111	170823
36532-PL2-003	181584	37420-657-003	180638	8-97138635-0	181185	11117	170825
36532-PL2-013	181584	37420-657-013	180638	8-97165951-0	181185	1112	170449
36532-PLA-G01	181591	37420-657-305	180638	8-97287352-0	181591	1112	171072
36532-PLM-A01	181591	37420-P13-003	180638	9-81360005	150395	11121	170824
36532-PLR-A01	181591	37420-P13-004	180638	9-81360007	150395	1114	170722
36532-PLR-A11	181591	37420-P13-013	180638	9-82511535	150395	1115	170965
36532-PMM-A01	181591	37420-P13-014	180638				
36532-PMP-A01	181590	37420-PA6-004	180638				

OE No.	HC-CARGO	OE No.	HC-CARGO	OE No.	HC-CARGO	OE No.	HC-CARGO
1115	171070	1390	171470	1641	170727	OK01A18861A	181585
1117	170720	1391	170583	1641	171109	OK04G 18861	181585
1119	170800	1392	170507	1645	170756	OK04G18861	181585
1121	170070	1392	171088	1645	171110	OK2011810XB	150426
1121	170333	1393	170849	1646	171033	OK2011810XC	150426
1122	170412	1393	171090	1651	170545	OK24718911	180317
1122	170836	1401	170340	1655	170610	OK2A5-18861	181588
1124	170723	1401	170773	1661	170357	OK2AB-18861	181588
1125	170696	1402	170413	1662	170358	OK2NA 18861	181591
1131	170576	1402	170794	1665	170611	OK2NA-18861	181591
1131	171073	1406	170455	1671	170612	OK2AA-18861	181588
1132	170478	1406	171118	1682	170613	OK30A18911	180317
1132	171074	1408LL	170660	1692	170757	OK32A 18861	181590
1134	170804	1410	171480	1692	171111	OK32B 18861	181590
1152	170006	1411	170339	1695	170753	OK900 18861	181584
1153	170361	1411	170772	1695	171112	OK95018211	180557
1155	170359	1412	170351	1696	170698	27120-21020	150096
1173	170718	1412	170793	1699	171025	27120-21050	150096
1176	170951	1415	170584	1700	171485	27301-2452S0	150279
1176	171953	1416	170454	1701	170590	27310-22000	150279
1177	170693	1416	171076	1705	170591	27360-32800	150377
1178	170694	1417	170938	1710	171484	28164-4A000	181495
1179	171039	1418LL	170663	1711	170341	31111-23001	070090
1181	170496	1431	170593	1711	171094	34240-657-013	180638
1182	170362	1432	170482	1712	170414	35170-22001	180317
1183	171009	1432	171102	1712	171096	35170-22010	180317
1184	171010	1500	171492	1715	170411	35170-23000	180317
1186	171034	1501	170346	1715	171095	39210 02500	181584
1187	171035	1501	170774	1720	171488	39210 02510	181584
1188	171036	1502	170417	1721	170343	39210 02610	181591
1189	171037	1502	170795	1721	171097	39210 02620	181591
1191	170493	1506	170503	1722	170415	39210 02630	181591
1191	171068	1510	171491	1722	171099	39210 02640	181591
1192	170494	1511	170345	1730	171489	39210 02900	181591
1195	170380	1511	171103	1731	170344	39210 02910	181591
1199	170681	1512	170416	1731	171098	39210 22017	181585
1200	171477	1512	170796	1732	170475	39210 22018	181584
1201	170338	1520	171490	1732	171100	39210 22026	181590
1201	170771	1521	170594	1735	170005	39210 22030	181588
1202	170350	1522	170474	1740	171486	39210 22045	181588
1211	170814	1540	171482	1741	170342	39210 22050	181588
1221	170815	1550	171483	1742	170592	39210 22051	181588
1231	170573	1551	170448	1750	171479	39210 22610	181591
1232	170574	1551	171119	1751	170588	39210 22620	181591
1241	170575	1552	170456	1752	170589	39210 22810	181591
1245	170579	1561	170580	1761	171139	39210 23025	181588
1248	170577	1601	170410	1836	170470	39210 23026	181588
1249	170578	1601	170775	1848	170380	39210 23030	181588
1301	170582	1601-AMBER	170782	1849	170502	39210 23035	181588
1302	170480	1601-BLUE	140784	1855	170839	39210 23036	181588
1310	171472	1601-GREEN	170783	1896	170741	39210 23046	181588
1311	170586	1601-RED	170785	1896	171082	39210 23500	181591
1312	170761	1602	170477	1897	170742	39210 23710	181591
1318LL	170658	1602	171108	1898	170751	39210 24310	181584
1320	171475	1603	170617	1899	170752	39210 24320	181584
1321	170335	1605	171283	1920	171042	39210 24520	181584
1321	170769	1606	171386	1921	171043	39210 24550	181584
1322	170349	1607	170813	1932	171044	39210 24610	181590
1322	170826	1608	170758	1950	171040	39210 24660	181590
1326	170451	1609	170755	2000	171132	39210 26700	181591
1326	171078	1611	170331	20238	170726	39210 2X020	181590
1338LL	170659	1611	171104	24338	170509	39210 32510	181584
1341	170336	1611-AMBER	170778	27225	170725	39210 32810	181584
1341	170770	1611-BLUE	170780	27243	171027	39210 33000	181590
1342	170452	1611-GREEN	170779	37755	170664	39210 33010	181590
1342	171092	1611-RED	170781	50440MPU	171064	39210 33030	181590
1345	170644	1612	170476	7234	171531	39210 33070	181590
1345	171093	1612	171106	H4360	H4360	39210 33340	181590
1351	170337	1612-AMBER	170805	H5360	H5360	39210 33440	181591
1352	170453	1612-BLUE	170807			39210 33461	181591
1361	170581	1612-GREEN	170806	KHD		39210 35110	181590
1362	170614	1612-RED	170808	1177424	150056	39210 35120	181590
1365	170816	1621	170347	4154913	150074	39210 35121	181590
1375	170585	1621	171105	454913	150074	39210 37140	181590
1376	170481	1622	170542			39210 37190	181590
1380	171471	1622	171107	KIA		39210 37510	181590
1381	170560	1624	170754	OK011 18861	181585	39210 37520	181590
1382	170483	1628LL	170662	OK011-18100	150252	39210 37523	181591
1383	170648	1631	170777	OK011-18861	181588	39210 37525	181590
1383	171089	1632	170776	OK01118911	180317	39210 37530	181590
1385	170673	1633	171398			39210 37540	181590

OE No.	HC-CARGO	OE No.	HC-CARGO	OE No.	HC-CARGO	OE No.	HC-CARGO
KIA continued							
39210 38005	181590	MBPD318861	181591	DAB403	150074	SMB511	181191
39210 38015	181591	MBPD3-18861	181591	DAB404	150154	SMB512	181182
39210 38025	181590	MBPD318861A	181590	DAB405	150098	SMB523	7. 6028
39210 38035	181590	MBPD418861	181591	DAB408	150173	SMB526	181201
39210 39025	181590	MBPD418861A	181591	DAB413	150229	SMB528	181212
39210 39027	181591	MZ553-18861	181591	DAB700	150062	SMB531	181194
39210 39030	181590	MZ55318861A	181590	DAB701	150061	SMB539	180785
39210 39500	181591	OK32B 18861	181590	DAB702	150064	SMB545	180757
39210 39550	181591			DAB750	150077	SMB546	180755
39210 39600	181590			DAB752	150067	SMB549	180787
39210 39650	181591	KUBOTA		DAB800	150088	SNB116	180839
39210 39660	181591	3518110	160311	DAB801	150165	SNB150	180950
39210 39800	181590			DAB953	150071	SNB163	180805
39210 39820	181590	KÄSSBOHRER		DAB954	150171	SNB171	180848
39210 39840	181591	0055454532	160444	DAJ101	150079	SNB172	180841
39210-02610	181591	737515000	160443	DAJ106	150091	SNB174	180871
39210-02620	181591	73751591000	160441	DAJ117	150097	SNB179	180805
39210-02630	181591			DAJ204	150068	SNB198	180937
39210-02640	181591			DAJ403	150092	SNB606	180959
39210-02900	181591	LADA		DAJ902	150157	SNB612	180963
39210-02910	181591	2101-3808600	180804	DAJ904	150236	SNB618	180985
39210-21320	181584	2101-3810600	180630	DJL400	150275	SNB700	180951
39210-21340	181584	2103-3808800	181001	DLB204	150185	SNB701	180954
39210-22030	181588	21080373491012	150071	DLB205	150183	SNB702	180953
39210-22045	181588	21080373491070	150071	DLB206	150184	SNB703	180945
39210-22050	181588	21083373491010	150071	DLB403	150192	SNB708	180949
39210-22051	181588	2108373491010	150071	DLB700	150217	SNB713	181015
39210-22610	181591	21088373491080	150071	DLB703	150187	SNB714	181005
39210-22620	181591	363734	150074	DLB704	150196	SNB715	181104
39210-22810	181591	TY37-0031183	150071	DLB800	150243	SNB718	181008
39210-23025	181588	TY370031183/85	150071	DPB812	150148	SNB723	181001
39210-23026	181588	TY37-0031185	150071	DSC02	160424	SNB727	181009
39210-23030	181588			DSC07	160427	SNB730	181021
39210-23035	181588	LUCAS		DSC18	160417	SNB746	181064
39210-23036	181588	21411918	150232	FDB501	160352	SNB750	181065
39210-23046	181588	30972	181183	FDB502	160350	SNB751	181070
39210-23500	181591	34228	181235	FDB503	160348	SNB756	181088
39210-23710	181591	34542	180790	FDB504	160295	SNB758	181093
39210-26700	181591	35291	181205	FDB505	160353	SNB767	181119
39210-2X010	181590	35630	181236	FDB506	160354	SNB768	181121
39210-32500	181584	35631	181183	FDB508	160372	SNB774	181128
39210-32520	181584	35670	181235	FDB509	160373	SNB775	181129
39210-33440	181591	36614	181237	FDB510	160374	SNB785	181034
39210334601	181591	38890B	181183	FDB511	160375	SNB792	181076
39210-33461	181591	54324157	181465	HDC101	160423	SNB793	181077
39210-35110	181591	54401850	150065	HDC102	160424	SNB796	181104
39210-37523	181591	54403549(2)	150055	HDC103	160425	SNB809	180875
39210-37525	181590	54403575(2)	150055	HDC104	160420	SNB811	180884
39210-38015	181591	54987086	150175	HDC105	160418	SNB814	180861
39210-38025	181591	80334A	150175	HDC107	160427	SNJ300	180811
39210-38035	181590	80334A	150380	HDC108	160416	SNJ400	180827
39210-39027	181591	84403	150072	HDC111	160419	SNJ404	180827
39210-39030	181590	84403D	150072	HDC113	160417	SNJ604	180832
39210-39500	181591	84890D	150175	HDC114	160458	SOB101	180649
39210-39550	181591	84896A	150072	HDC115	160444	SOB103	180649
39210-39650	181591	8490D	150175	HDC116	160441	SOB104	180649
39210-39660	181591	84950	150072	HDC117	160443	SOB111	180652
39210-39840	181591	84950A	150072	HDC118	160442	SOB500	180634
39220-22010	180875	84972	150072	HDC122	160426	SOB501	180634
39330-24750	180557	84987	150221	HDC124	160438	SOB502	180634
39350 32510	181584	84988	150221	HDC125	160436	SOB503	180658
94750-11010	180641	9490D	150380	HDC126	160434	SOB507	180635
94750-11102	180641	BAE209C	150183	HDC127	160421	SOB510	180704
94750-11110	180641	BAE504B	150185	HDC128	160469	SOB600	180631
94750-21000	180641	BAE506D	150243	OPS101	180649	SOB601	180631
94750-21010	180641	BAE507AK	150184	OPS103	180649	SOB700	180630
94750-21020	180641	BAE800AK	150246	OPS104	180649	SOB701	180630
94750-21030	180641	DAB101	150065	OPS110	180634	SOB702	180630
94750-32030	180638	DAB118	150072	OPS112	180631	SOB708	180665
96056-317	150377	DAB125	150175	OPS113	180631	SOB711	180689
AOH021	070090	DAB128	150071	OPS115	180630	SOB712	180702
KK348 18861	181584	DAB129	150072	OPS116	180630	SOB802	180636
MBP0318861B	181584	DAB132	150221	SFB165	160314	SOB805	180638
MBP3C 18861	181591	DAB133	150221	SMB406	180009	SOB807	180641
MBP3C18861	181591	DAB134	150175	SMB411	180732	SOB813	180645
MBP3C-18861	181591	DAB200	150055	SMB412	180731	SOJ121	180657
MBP3D 18861	181591	DAB201	150055	SMB417	180732	SPB400	180790
MBP3D18861	181591	DAB202	150176	SMB418	180734	SSB100	181476
MBP3D-18861	181591	DAB400	150056	SMB423	180790	SSB101	181476
MBP3D18861A	181591	DAB401	150057	SMB509	181202	TGE426A	160376
MBPD3 18861	181591	DAB402	150075	SMB510	181179		

OE No.	HC-CARGO	OE No.	HC-CARGO	OE No.	HC-CARGO	OE No.	HC-CARGO
MAGNETI MARELLI		940038525	150061	1A08-18-861A	181590	BP4X-18-861	181591
060705604010	150243	940038526	150063	1A10-18-861	181591	BP4X-18-861A	181591
060705738010	150184	940038527	150065	1A16-18-861	181591	BP4X-18-861A9U	181591
060708038010	150246	940038540	150067	1A17-18-861	181591	BP4Y-18-861A	181591
064342204010	160671	940038542	150077	1E00-18-221	150442	BP4Y-18-861C	181591
064342210010	160671	940038544	150072	1E00-18-501	180636	BP4Y-18-861C9U	181591
064342601010	160376	940038546	150221	1E00-18-501A	180636	BP6F-18-861	181590
064820083010	150183	940038550	150236	1E00-18-510	181411	BP6F-18-861B	181590
064820150010	150332	940038551	150097	1E04-18-10X	150416	BP6F-18-861B9U	181590
064833010010	150058	940038554	150092	1E04-18-760	180893	BP6G-18-861	181591
064833020010	150055	940038555	150091	1E04-18-760A	180893	BP6G-18-861C	181591
064833031010	150165	940038562	150079	2851-18-100A	150395	BP6G-18-861C9U	181591
064833032010	150056	940038570	150071	3607-18-100	150395	BPD3-18-861A9U	181591
064833036010	150165	940038580	150232	3607-18-100A	150395	BPD3-18-891A9U	181591
064833040	150088	940038603	150075	3F01-18-251	150160	BPD4-18-861	181591
064833100010	150057	940138501	150055	8174-24-910	150068	BPD4-18-861A	181591
071328401	150148	940385521	150058	8574-18-840	180914	BPD4-18-861A9U	181591
071347301	150148	943251220010	150173	8574-24-910	150068	BPE1-18-861	181590
071349101010	150148	943251408010	150056	8601-18-861	181584	BPE1-18-861A	181590
0940038506	150154	99400096	150088	AJ03-18-861D	181590	BPE1-18-861A9U	181590
0940038510	150173	BAE800EK	150419	AJ51-18-861	181590	BPE8-18-861	181591
0940038522	150064	BAE801EK	150419	AJ51-18-8619U	181590	BPE8-18-861A	181591
0940038526	150063	BKL1A	150058	AJ52-18-861	181591	BPE8-18-861A9U	181591
0940038540	150067	BKL2A	150055	AJ52-18-861A	181591	BPS1-18-861	181591
0940038570	150071	BKL3B	150165	AJ52-18-861A9U	181591	BPS1-18-862B	181591
0941038520	150062	BKL3BD	150165	AJ53-18-861A	181590	C201-18-861	181591
116451089902	180702	BKL3C	150056	AJ53-18-861A9U	181590	C601-18-861	181591
116451119903	180704	BKL4A	150088	AJ57-18-861A	181590	D410-18-100A	150395
116459169917	180631	MTR01	150055	AJ57-18-861B	181590	E563-18-861	181584
116459169925	180631	MTR02	150057	AJ59-18-861B	181590	E564-18-861	181584
116459169926	180630	MTR03	150098	AJ59-18-861C	181590	E565-18-861	181584
116580459904	180945	MTR2	150057	AJ60-18-861A	181590	E663-18-861	181584
116580679904	181021	REP1A	160423	AJ60-18-861B	181590	ET30-12-4910	150096
116580729901	181001	SE138992100A	160427	AJ95-18-861	181590	F201-18-861	181584
116580729908	181009	SEN8D	150333	AJ95-18-8619U	181590	F201-18-861A	181584
116580729913	181005	SEN8M	150332	AM15-18-861	181584	F201-18-861A9U	181584
116580739902	181009	MAGNETON (PAL/SKODA)		AM15-18-V20	150096	F210-18-100	150275
116580739927	181005	443213221020	150215	AM30-18-861	181584	F210-18-100B	150275
116596409901	180804	852018	180634	AM30-18-8619U	181584	F211-18-100A	150275
116596729902	180805	852076	180634	B303-18-861B	181584	F287-18-861	181584
34542	180790	TZP443213221020	150215	B303-18-V20	150417	F829-18-861	181584
54403549	150055	MAN		B31R-18-861A	181585	F829-18-V20	150160
54403575	150055	81.25229-6051	170968	B359-18-861	181584	F8G8-18-861	181282
581701010000	150165	81.25475-0152	192902	B365-18-501	180641	F8G8-18-8619U	181584
581701020000	150165	81.66804-6032	171797	B366-18-501	180641	FE05-18-861	181584
581701070000	150088	81.66804-6034	171797	B367-18-501	180641	FE86-18-861	181584
581701080000	150057	MAZDA		B376-18-861	181584	FE86-18-861A	181584
60705604	150243	0118-18-510	180811	B3C7-18-861A	181585	FE86-18-861B9U	181584
60705701	150184	0118-89-181	180811	B541-18-V20	150234	FEFB-18-V20	150160
60705738	150184	0222-18-100A	150395	B564-18-861	181584	FEH1-18-861	181584
60708038	150246	0222-18-501A	180638	B5E1-18-861B	181590	FEH1-18-8619U	181584
64820083	150333	0258-00-2035	181584	B5F3-18-861A	181590	FP33-18-861B	181590
64822032	150056	0290-18-100	150395	B601-18-861	181584	FP35-18-861B	181590
64833010	150058	0294-18-100	150395	B61R-18-861	181584	FP49-18-861	181591
64833020	150055	0324-18-100	150395	B61R-18-861A	181584	FP49-18-8619U	181591
64833031	150165	0381-18-100	150395	B61R-18-861A9U	181584	FP50-18-861	181591
64833031010	150165	0419-18-100	150395	B61R-18-861B	181584	FP50-18-861A	181591
648330311010	150165	0453-18-100	150395	B61Z-18-861A	181584	FP50-18-861A9U	181591
64833036	150165	0483-18-100B	150395	B64N-18-861	181282	FS1G-18-861	181591
64833040	150088	0483-18-100C	150395	B6A7-18-861	181584	FS1G-18-861A	181591
648330400010	150088	0483-24-921	150395	B6A7-18-861	181584	FS1H-18-861	181591
64833060	150057	0512-18-100	150395	B6B1-18-861	181584	FS1H-18-861A	181591
64833060010	150057	0522-18-100	150395	B6B1-18-8619U	181584	FS1H-18-861A	181591
64833100	150057	0710-18-100	150395	B6B3-18-861	181584	FS1J-18-861	181590
648331000010	150057	0710-18-100B	150395	B6B3-18-861A	181584	FS1J-18-861A	181590
64833131	150165	0813-18-501	180638	B6DC-18-861	181585	FS1K-18-861	181591
71328401	150148	OK2AB-18-861	181588	B6DC-18-861A	181585	FS1K-18-861A	181591
71347301	150148	1345-18-501	180641	BEH1-18-861	181584	FS1K-18-861A	181591
71349101	150148	1689-18-100	150395	BEH1-18-861	181584	FS2V-18-861A	181590
940038500	150056	1744-18-100	150395	BP01-18-251	150371	FS2V-18-861B9U	181590
940038501	150055	1744-18-100A	150395	BP03-18-861	181584	FS7N-18-861	181590
940038502	150057	1A01-18-861	181584	BP03-18-861A	181584	FS7N-18-8619U	181590
940038503	150075	1A02-13-210A	181591	BP03-18-861B	181584	FS8B-18-861A	181591
940038504	150171	1A02-18-861	181591	BP03-18-861B9U	181584	FSAX-18-861	181591
940038505	150074	1A06-18-861A	181591	BP3A-18-861	181591	FSAX-18-861U	181591
940038506	150154	1A08-18-861	181590	BP3A-18-8619U	181591	FSC1-18-861	181590
940038507	150172	ACCESSORIES		BP3B-18-861	181591	FSC1-18-861A	181590
940038510	150173			BP3B-18-862	181591	FSC1-18-861B	181586
940038518	150176			BP3B-18-8629U	181591	FSC1-18-861B9U	181590
940038520	150062			BP3C-18-8619U	181591	FSC5-18-861	181585
940038522	150064			BP3D-18-861	181591	FSC5-18-861A	181585
				BP3D-18-8619U	181591	FSC5-18-861A9U	181585
				BP4W-18-861B	181591	FSC6-18-861	181590

OE No.	HC-CARGO	OE No.	HC-CARGO	OE No.	HC-CARGO	OE No.	HC-CARGO
MAZDA continued							
FSC6-18-861A	181590	KL1E-18-861A	181590	N3A1-18-861A	181282	0005402417	181586
FSC6-18-861A9U	181590	KL1E-18-861A9U	181590	N3A1-18-861A9U	181584	0005402617	181586
FSD7-18-861A	181590	KL47-18-861	181590	N3H3-18-861A	181591	0005402717	181586
FSE1-18-861	181591	KL47-18-861A	181590	N3H3-18-861B	181591	0005402917	181586
FSE1-18-861A	181591	KL47-18-861B	181590	N3H3-18-861B9U	181591	0005403817	181586
FSE1-18-861B	181591	KL61-18-861A9U	181590	O370-18-100	150395	0005404117	181586
G601-18-10X	150523	KL62-18-861	181590	R207-18-501	180638	0005404517	181586
G601-18-V20	150235	KL62-18-861A	181590	R207-18-5010	180638	0005404917	181586
G602-18-10X	150523	KL62-18-861A9U	181590	TA34-18-861A	181590	0005405017	181586
G607-18-10X	150523	KLA6-18-861	181590	YF09-18-10X	150416	0005405117	181586
G608-18-10X	150523	KLA6-18-861A	181590	YF09-18-221	150442	0005405517	181586
G609-18-861	181584	KLA7-18-861	181590	Z501-18-861	181590	0005405617	181586
G622-18-10X	150523	KLA7-18-861A	181590	Z501-18-861A	181590	0005405917	181586
G623-18-10X	150523	KLC4-18-861A	181590	Z501-18-861A9U	181590	0005408617	181586
GY01-18-861A	181590	KLC7-18-861	181589	Z553-18-861	181590	0005454214	181197
GY01-18-861A9U	181590	KLC7-18-861A	181589	Z553-18-861A	181590	0005457709	180783
GY02-18-861B	181591	KLC7-18-861B	181589	Z553-18-861A9U	181590	0005458609	180783
GY02-18-861B9U	181591	KLC7-18-861B9U	181589	ZL27-18-861A	181590	0005459909	180783
GY03-18-861A	181590	KLC8-18-861	181590	ZM01-18-861	181591	0008601326	160197
GY03-18-861B	181590	KLC8-18-861A	181590	ZM01-18-861A9U	181591	0008602026	160197
GY03-18-861B9U	181590	KLC8-18-861A9U	181590	ZM02-18-861	181591	0008603326	160197
GY04-18-861	181591	KLD4-18-861	181590	ZM02-18-861A	181591	0008603526	160197
GY04-18-861B	181591	KLD4-18-861A	181590	ZM02-18-861A9U	181591	001 540 01 17	181588
GY04-18-861B9U	181591	KLD4-18-861A9U	181590	ZM03-18-861A9U	181590	001 540 04 17	181590
GY05-18-861	181591	KLD8-18-861	181589	ZM40-18-861A	181591	001 540 05 17	181592
GY05-18-861A	181591	KLD8-18-8619U	181589	ZZM1-08-033A	150168	001 540 07 17	181592
GY05-18-861A9U	181591	KL4-18-861	181590	ZZM1-18-707	181411	001 540 08 17	181588
GY06-18-861	181591	KL4-18-861A	181590	ZZM3-18-860	181590	001 540 10 17	181588
GY06-18-861A	181591	KLJ9-18-861A	181590	ZZME-18-861	181590	001 540 11 17	181588
GY06-18-861A9U	181591	KLJ9-18-861B	181590	ZZMF-18-861	181590	001 540 12 17	181588
JE081-88-61B	181587	KLJ9-18-861D	181590	ZZP1-18-861	181591	001 540 13 17	181586
JE08-18-861B	181586	KLL5-18-861	181590	ZZR1-18-861	181591	001 540 28 17	181588
JE15-18-V20	150235	KLL5-18-861B	181590	MERCEDES BENZ			
JE46-18-86Z	181584	KLL5-18-861B9U	181590	000 540 24 17	181586	001 540 37 17	181592
JE48-18-10XB	150523	KLL6-18-861	181590	000 540 26 17	181586	001 540 38 17	181592
JE48-18-861	181590	KLL6-18-861A	181590	000 540 27 17	181586	001 540 46 17	181592
JE48-18-861A	181590	KLL6-18-861B	181590	000 540 29 17	181586	001 540 47 17	181592
JE48-18-861A9U	181590	KLL6-18-861C	181590	000 540 38 17	181586	001 540 50 17	181592
JE49-18-10XB	150523	KLL8-18-861	181590	000 540 39 17	181586	001 540 51 17	181592
JE49-18-861A	181590	KLL8-18-861A	181590	000 540 41 17	181586	001 540 60 17	181592
JE50-18-861	181590	KLL8-18-861A9U	181590	000 540 45 17	181586	001 540 70 17	181592
JE50-18-861A	181590	KLL9-18-861	181590	000 540 48 17	181589	001 540 71 17	181592
JE50-18-861B	181590	KLL9-18-861A	181590	000 540 49 17	181586	001 540 73 17	181592
JE96-18-861	181591	KLL9-18-861A9U	181590	000 540 50 17	181586	001 540 74 17	181592
JE96-18-861A	181591	KLM6-18-861	181590	000 540 51 17	181586	001 540 75 17	181592
JE96-18-861A9U	181591	KLM7-18-861	181591	000 540 52 17	181589	001 540 76 17	181592
JE97-18-861	181590	KLS2-18-861	181590	000 540 55 17	181586	001 540 79 17	181591
JE97-18-861A	181590	KLS2-18-861A	181590	000 540 56 17	181586	001 540 80 17	181592
JE97-18-861A9U	181590	KLS2-18-861B	181590	000 540 57 17	181586	001 540 85 17	181592
JE99-18-86Z	181591	KLS3-18-861	181590	000 540 59 17	181586	001 540 87 17	181592
JE99-18-86Z9U	181591	KLS3-18-861A	181590	000 540 60 17	181592	001 540 92 17	181592
JF01-18-100B	150275	KLS3-18-861B	181590	000 540 62 17	181590	001 540 95 17	181591
JF01-18-251	150160	KLS3-18-861A9U	181590	000 540 65 17	181589	0012012000	070192
K802-18-861C	181590	KLS6-18-861	181590	000 540 71 17	181588	0015400517	181592
K805-18-861A9U	181591	KLS6-18-861A	181590	000 540 72 17	181588	0015400717	181592
K806-18-861A	181591	KLS7-18-861	181590	000 540 73 17	181586	0015401317	181586
K806-18-861A9U	181591	KLS7-18-861A	181590	000 540 74 17	181588	0015403717	181592
KF33-18-861A	181590	L321-18-861A	181590	000 540 75 17	181588	0015403817	181592
KF34-18-861A	181590	L321-18-861B	181590	000 540 76 17	181588	0015404617	181592
KF34-18-861B	181590	L334-18-861A	181590	000 540 81 17	181588	0015404717	181592
KJ01-18-861	181585	L334-18-861B	181590	000 540 82 17	181586	0015405017	181592
KJ01-18-861A	181585	L336-18-861	181591	000 540 83 17	181586	0015405117	181592
KJ01-18-861A9U	181585	L363-18-861A	181591	000 540 85 17	181588	0015405117	181592
KJ02-18-861A	181585	L364-18-861	181591	000 540 86 17	181586	0015406017	181592
KJ02-18-861B	181585	L395-18-8G1	181591	000 540 89 17	181588	0015406270	171311
KJ02-18-861C	181585	L3A1-18-861A	181591	000 540 90 17	181588	0015406370	171308
KJ02-18-861C9U	181585	L3A1-18-861A9U	181591	000 540 91 17	181588	0015407017	181592
KJ03-18-861	181590	LF17-18-861C	181591	000 540 92 17	181588	0015407117	181592
KJ03-18-861B	181590	LF66-18-861A	181590	000 540 95 17	181590	0015407317	181592
KJ03-18-861B9U	181590	LF66-18-861B	181590	000 540 96 17	181588	0015407417	181592
KJ04-18-861	181590	LF66-18-861B9U	181590	000 540 97 17	181588	0015407517	181592
KJ04-18-861A	181590	LF66-18-861B9U	181590	000 640 96 17	181588	0015407617	181592
KJ04-18-861B	181590	LF67-18-861A	181591	0000940948	181500	0015407917	181591
KJ04-18-861A9U	181590	LF68-18-861B	181591	0000941048	181500	0015408017	181592
KJ04-18-861B	181590	LF68-18-861B9U	181591	0001580003	150395	0015408517	181592
KJ04-18-861B9U	181590	LF69-18-861A	181591	0001583803	150395	0015408717	181592
KJ04-18-861C	181590	LF69-18-861B	181591	0001585303	150257	0015409217	181592
KJ04-18-861C9U	181590	LF69-18-861C	181591	0001585403	150257	0015409517	181591
KL1C-18-861	181590	LF69-18-861D	181591	0001586103	150257	0015450109	180783
KL1C-18-8619U	181590	N304-18-861	181584	0001586203	150257	0015454714	181197
KL1D-18-861	181590	N326-18-861	181584	0001587003	150424	0015455405	160394
KL1D-18-8619U	181590	N350-18-861	181282	0001587103	150424	0015455605	160466
KL1E-18-861	181590	N3A1-18-861	181584	0001587503	150424	0015458214	181197

OE No.	HC-CARGO	OE No.	HC-CARGO	OE No.	HC-CARGO	OE No.	HC-CARGO
0015458632	150154	007 542 94 17	181585	A0015403817	181592	DYE923	150068
0015459732	160441	0075420917	180931	A0015404617	181592	EJN902	150096
0015459832	160443	0075426817	181584	A0015404717	181592	J007T00371	150068
0018305608	160631	0075451632	160448	A0015405017	181592	J007T01571	150234
0018351364	070206	0075459832	160445	A0015405117	181592	J007X00671	150160
002 540 01 17	181591	0075459932	160447	A0015406017	181592	J007X00812	150417
002 540 06 17	181591	0085425617	181388	A0015407017	181592	J007X00871	150160
002 540 08 17	181591	0085450032	160446	A0015407117	181592	J007X00872	150235
002 542 12 18	181584	009 542 05 17	181585	A0015407317	181592	J007X00971	150377
0025400117	181591	009 542 06 17	181585	A0015407417	181592	J007X01172	150234
0025400617	181591	009 542 38 17	181584	A0015407517	181592	J007X01175	150234
0025400817	181591	009 542 43 17	181585	A0015407617	181592	J007X01271	150377
0025421218	181584	009 542 45 17	181585	A0015407917	181591	J007X02772	150235
0025424232	160442	009 542 87 17	181585	A0015408017	181592	J009T02071	150377
0025424332	160442	0095423817	181584	A0015408517	181592	J106	150068
0025427317	180931	0095429017	181587	A0015408717	181592	J117	150160
0025445503	171306	0095429117	181587	A0015409217	181592	J120	150234
0025450532	160441	0095429217	181587	A0015409517	181591	J121	150377
0025450632	160443	0095429317	181587	A0025400117	181591	J131	150221
0025451832	150154	0095429417	181587	A0025400617	181591	J152	150096
0025451905	160470	0125458832	160705	A0025400817	181591	J153	150378
0025452005	160470	0125458932	160706	A0025421218	181584	J170	150234
0025452105	160470	0255455432	160449	A0045420718	181591	J170A	150234
0025452632	150154	1130940048	181500	A0045420818	181591	J207	150417
0025454032	150154	1405450414	181184	A0055422417	181584	J208	150235
0025454232	160442	1408218351	160794	A0055422517	181584	J701	150371
0025454332	160442	1408218451	160794	A0055426217	181584	J862	150512
0025455832	150154	1408690221	160679	A0055426317	181584	J9T03372	150377
0025455932	150154	2015450014	181184	A0055427317	181584	MO 4606037	181590
0025459032	150154	2018210047	160287	A0055428517	181584	MO 4671052	181591
0031585001	150516	2218690121	160379	A0065421917	181584	MO 5269711	181590
0035445203	171299	554 224 17	181584	A0065422117	181584	MO4671066	181590
0035445303	171302	6388600126	160197	A0065422217	181584	MC840219	180641
0035445403	171303	654 221 17	181584	A0065422317	181584	MD001482	180641
0035445503	171299	9094302225	160794	A0065429017	181585	MD001483	180641
0035445603	171302	A0005402417	181586	A0065429617	181585	MD001800	150395
0035451632	150154	A0005402617	181586	A0075423117	181585	MD001804	150395
0035451732	150154	A0005402717	181586	A0075423217	181585	MD003801	150395
0035451905	160470	A0005402917	181586	A0075425217	181585	MD003804	150395
0035452005	160470	A0005403817	181586	A0075426817	181585	MD003806	150395
0035452532	160444	A0005404117	181586	A0075429417	181585	MD008820	150395
0035454032	150154	A0005404517	181586	A0095420517	181585	MD008821	150395
0035454132	150154	A0005404817	181589	A0095420617	181585	MD011225	181584
004 542 07 18	181591	A0005404917	181586	A0095423817	181584	MD017430	180641
004 542 08 18	181591	A0005405017	181586	A0095424317	181585	MD017612	150395
0045420718	181591	A0005405217	181589	A0095424517	181585	MD021566	180641
0045420818	181591	A0005405517	181586	A0095428717	181585	MD021567	180641
0045425617	180931	A0005405617	181586	A0095429017	181587	MD073175	181584
0045452614	180648	A0005405917	181586	A0095429117	181587	MD073461	181584
005 542 24 17	181584	A0005406017	181592	A0095429217	181587	MD073546	181584
005 542 25 17	181584	A0005406217	181590	A0095429317	181587	MD076706	181584
005 542 62 17	181584	A0005406517	181589	A0095429417	181587	MD077621	181584
005 542 63 17	181584	A0005407117	181588			MD078791	181584
005 542 73 17	181584	A0005407217	181588			MD088116	181584
005 542 85 17	181584	A0005407317	181586	MITSUBISHI		MD088616	181584
0054524532	160444	A0005407417	181588	1588A002	181591	MD089922	181584
0055422417	181584	A0005407517	181588	1588A005	181591	MD107793	181584
0055422517	181584	A0005407617	181588	1588A020	181590	MD107934	181584
0055426217	181584	A0005408117	181588	1588A021	181591	MD108931	181584
0055426317	181584	A0005408217	181586	1588A043	181591	MD109613	181584
0055427317	181584	A0005408317	181586	1588A050	181591	MD110487	181584
0055428517	181584	A0005408317	181586	1588A051	181591	MD110492	181584
0058205010	160794	A0005408517	181588	1588A069	181591	MD117240	181584
006 542 19 17	181584	A0005408617	181586	1588A070	181591	MD117242	181584
006 542 21 17	181584	A0005408917	181588	1588A107	181591	MD117280	181584
006 542 22 17	181584	A0005409017	181588	1588A117	181591	MD119210	181584
006 542 23 17	181584	A0005409117	181588	1588A206	181590	MD119609	181584
006 542 90 17	181585	A0005409517	181590	1588A207	181590	MD121306	181584
006 542 96 17	181585	A0005409617	181588	1588A209	181591	MD126181	181584
0065421917	181584	A0005409717	181588	1588A210	181591	MD127062	181584
0065422117	181584	A0006409617	181588	3921021320	181584	MD128262	181584
0065422117KZ	181584	A0015400117	181588	3921021340	181584	MD129183	181584
0065422217	181584	A0015400417	181590	3921024520	181584	MD129550	150377
0065422217KZ	181584	A0015400517	181592	3921024550	181584	MD131446	181584
0065422317	181584	A0015400717	181592	56028998AB	181591	MD131447	181584
0065422317KZ	181584	A0015400817	181588	56029049AA	181590	MD131540	181584
0065453724	180959	A0015401017	181588	56029050AA	181590	MD132243	150377
0065459024	181000	A0015401117	181588	9475021010	180641	MD136308	181590
007 542 31 17	181585	A0015401217	181588	9475021020	180641	MD136309	181584
007 542 32 17	181585	A0015401317	181586	9475021030	180641	MD136310	181590
007 542 52 17	181585	A0015402817	181588	AW327504	181584	MD136491	181590
007 542 68 17	181585	A0015403717	181592	CYGS065A	150157	MD136493	181590

OE No.	HC-CARGO	OE No.	HC-CARGO	OE No.	HC-CARGO	OE No.	HC-CARGO
RLPA424	160215	22433-56E11	150273	22690-7B520	181589	226A0-3S506	181589
RLPA5212	160316	22433-58000	150395	22690-81F02	181589	226A0-3S507	181589
RLPA5224	160317	22433-78500	150395	22690-81F12	181589	226A0-3S508	181589
RLPD12	160267	22433-78510	150395	22690-8J001	181591	226A0-3S511	181589
RLPS12	160282	22433-79011	150395	22690-8J010	181591	226A0-3S512	181589
RLPS412	160282	22433-79012	150395	22690-8U000	181590	226A0-3S513	181589
RLPS424	160307	22433-L1610	150395	22690-8U300	181591	226A0-3S560	181589
RLPS5212	160308	22433-L6800	150395	22690-95E00	181584	226A0-3S561	181589
RLPS5224	160337	22433-L6801	150395	22690-9S200	181585	226A0-3S570	181589
RP10024	160721	22448-00QAA	150505	22690-AE201	181585	226A0-3S571	181589
RP12012	160720	22630-10G00	180874	22690-AG920	181585	226A0-3S575	181589
RTP612	160461	22630-G2402	180874	22690-AG921	181585	226A0-3S601	181589
RZE212	160347	22630-G2404	180874	22690-AH120	181585	226A0-3S602	181589
TDP1212	160423	22630-N4200	180874	22690-AH121	181585	226A0-3S603	181589
TPD1010	160426	22690-01P00	181585	22690-AL600	181590	226A0-3S606	181589
TPD512	160424	22690-01Y00	181584	22690-AN210	181585	226A0-3S607	181589
TPD612	160425	22690-07G01	181584	22690-AN215	181585	226A0-3S608	181589
TPDSG612	160451	22690-09P00	181585	22690-AQ800	181591	226A0-3S660	181589
TPF612	160416	22690-09P01	181585	22690-AR202	181585	226A0-3S661	181589
TPPF612	160469	22690-0E000	181585	22690-AW003	181585	226A0-3S665	181589
TPPSS712	160421	22690-0M200	181585	22690-D4200	181585	226A0-3S666	181589
TPPSS712	160422	22690-0S200	181584	22690-F2500	181584	226A0-4J901	181589
TRM1212	160438	22690-0U000	181584	22690-F2510	181584	226A0-4J903	181589
TRMC1212	160439	22690-0W001	181585	22690-F2520	181584	226A0-4L710	181589
TRMF1212	160452	22690-12P00	181585	22690-F5100	181584	226A0-4L711	181589
TRMK1212	160438	22690-12P01	181585	22690-F5300	181584	226A0-4L713	181589
TRMN1212	160439	22690-17B00	181584	22690-F5360	181584	226A0-4M210	181589
		22690-19B10	181584	22690-HA005	181591	226A0-4M221	181589
NEC		22690-1B000	181590	22690-J8000	181584	226A0-4S000	181589
MC5357	150097	22690-1B010	181590	22690-J9200	181584	226A0-4S001	181589
MC8132	150236	22690-1E400	181584	22690-P5100	181584	226A0-4S010	181589
MC8183	150236	22690-20R00	181584	22690-P6500	181584	226A0-4S011	181589
MC8541	150236	22690-28F60	181585	22690-P6510	181584	226A0-4S100	181589
		22690-2A000	181590	22690-P6590	181584	226A0-4S101	181589
NIKKO		22690-2B000	181584	22690-V2000	181584	226A0-4S102	181589
0-0274-06652	191645	22690-2J200	181585	22690-V4000	181584	226A0-4S103	181589
0-0276-06352	192063	22690-2J201	181585	22690-V4060	181584	226A0-4S110	181589
		22690-2S700	181585	22690-V5201	181585	226A0-4S112	181589
		22690-2S701	181585	22690-V5202	181585	226A0-4S113	181589
NISSAN		22690-2U801	181585	22690-V9410	181584	226A0-4W001	181589
01436-00QAB	150404	22690-2Y010	181585	22690-VG301	181585	226A0-4W005	181589
01501081-0	160282	22690-2Y020	181585	22690-VG303	181585	226A0-4W010	181589
01501189-0	160327	22690-2Y021	181585	22690-WD800	181585	226A0-5E410	181589
01505634-0	160311	22690-2Y500	181585	22690-WD801	181585	226A0-5E411	181589
01505997-0	160282	22690-2Y510	181585	22691-0W000	181585	226A0-5E412	181589
01506377-0	160311	22690-2Y520	181585	22691-2Y020	181585	226A0-5E413	181589
01506437-0	160282	22690-2Y521	181585	22691-2Y021	181585	226A0-5E460	181589
01506584-0	160308	22690-30R00	181584	22691-4L001	181585	226A0-5E461	181589
22020-03A00	150091	22690-30R15	181584	22691-4L003	181585	226A0-5M010	181589
22020-0B000	150221	22690-31U00	181585	22691-5W900	181590	226A0-5M011	181589
22020-15M00	150091	22690-31U01	181585	22691-6N205	181585	226A0-5M012	181589
22020-15M20	150091	22690-3C202	181585	22691-6N206	181585	226A0-5W900	181591
22020-15U20	150091	22690-4A0A3	181591	22691-8U000	181590	226A0-5Y700	181589
22020-53E17	150221	22690-4E810	181584	22691-AH121	181585	226A0-5Y701	181589
22020-53J10	150221	22690-4E811	181584	22691-AR210	181590	226A0-67U01	181589
22020-53J20	150221	22690-4J901	181589	22691-VG301	181585	226A0-67U03	181589
22020-55Y00	150221	22690-4J903	181589	22691-VG303	181585	226A0-6B701	181589
22020-56E11	150221	22690-4L000	181585	226A0-0L710	181589	226A0-6B702	181589
22020-56E16	150221	22690-4L002	181585	226A0-0L711	181589	226A0-6B703	181589
22020-56E17	150221	22690-4M500	181585	226A0-0L712	181589	226A0-6M402	181589
22020-70J00	150221	22690-4M805	181585	226A0-0L713	181589	226A0-6M406	181589
22020-71J00	150221	22690-4M815	181585	226A0-0W000	181589	226A0-6N161	181590
22020-G5111	150160	22690-4M820	181585	226A0-0W001	181589	226A0-6P101	181589
22020-P4005	150091	22690-4W010	181585	226A0-0W002	181589	226A0-6P103	181589
22020-S6701	150079	22690-4W012	181585	226A0-0W010	181589	226A0-6P104	181589
22020-S6702	150079	22690-50Y00	181584	226A0-0W011	181585	226A0-6P107	181589
22433-08000	150273	22690-55Y00	181584	226A0-0W012	181589	226A0-6P108	181589
22433-14800	150395	22690-56E00	181585	226A0-1B010	181590	226A0-7B013	181589
22433-14805	150395	22690-5E410	181589	226A0-1B011	181590	226A0-7B014	181589
22433-14806	150395	22690-5E411	181589	226A0-1B012	181590	226A0-7B503	181589
22433-14810	150395	22690-5M500	181585	226A0-1B013	181590	226A0-7B504	181589
22433-14811	150395	22690-5M501	181585	226A0-1S700	181590	226A0-7J100	181589
22433-14815	150395	22690-5W900	181590	226A0-1S705	181590	226A0-7J101	181589
22433-14816	150395	22690-6A0A0	181591	226A0-1S710	181590	226A0-7J400	181589
22433-14900	150395	22690-6A0A1	181591	226A0-1S715	181590	226A0-7J401	181589
22433-14905	150395	22690-6A0A2	181591	226A0-2Y901	181589	226A0-7J402	181589
22433-31300	150395	22690-6N205	181585	226A0-2Y902	181589	226A0-7S001	181591
22433-31303	150395	22690-6N206	181585	226A0-2Y904	181589	226A0-81F01	181589
22433-51J10	150273	22690-6P107	181589	226A0-3S501	181589	226A0-81F02	181589
22433-53J20	150273	22690-75P00	181585	226A0-3S502	181589	226A0-81F04	181589
22433-55S10	150273	22690-75P10	181585	226A0-3S503	181589	226A0-81F11	181589

OE No.	HC-CARGO	OE No.	HC-CARGO	OE No.	HC-CARGO	OE No.	HC-CARGO
NISSAN continued							
226A0-81F12	181589	NTK		1252506	180630	90062964	150098
226A0-8J010	181591	AS108-7H	181282	1252555	181341	90187341(2)	150056
226A0-8U300	181591	OTA7H-P361	180371	1252573	181341	90188755	150098
226A0-9E800	181589	OTA7H-P3C1	180371	12565428	181591	90228928	160416
226A0-9E801	181589	OTD3G-P3A1	180359	12567680	181591	90240651	160416
226A0-AM601	181591	OZA25-F6	181282	12569391	181591	90241775	150173
226A0-AR210	181591	OZA446-E48	180421	13101741	160904	90243618	150175
226A0-AU011	181591	OZA447-E16	180485	13141026	181129	90292723	070053
226A0-EA200	181591	OZA448-E31	180485	1337464	150175	90296502	150173
226A0-EA210	181591	OZA572-E1	181284	1338444	180875	90297786(2)	150173
226A1-0W002	181589	OZA572-E13	181284	1338448	180808	90320586	150173
226A1-18Y01	181589	OZA572-E9	180485	1338451	180875	90349944	070053
226A1-18Y02	181589	OZA65-A2	181282	1338454	180884	90350787	150173
226A1-18Y03	181589	OZA71-F1	181282	1338458	180875	90360315	150175
226A1-18Y05	181589			1338467	181395	90383817	160549
226A1-4L711	181589	OKI		1338506	180636	90397486(2)	150173
226A1-4L712	181589	MNE-300	150097	1338511	181395	90411959	180371
226A1-4L715	181589	MNE-301	150236	1341010	181034	90421995	160548
226A1-4S100	181589	MNE-302	150236	1341028	181055	90443900	150519
226A1-4S101	181589	MNE-303	150236	1341030	181088	90444189	150387
226A1-4S102	181589			1341039	181129	90444650	150379
226A1-4S103	181589	OPEL		1341044	181129	90448286	070203
226A1-4W001	181589	1207248	150055	13411010	181034	90449572	150519
226A1-4W004	181589	1208008	150525	1342561	180808	90449574	150379
226A1-4W010	181589	1208022	150217	1342567	180808	90450998	160549
226A1-4W011	181589	1208031	150217	1342568	180808	90462248	150387
226A1-5M011	181589	1208037	150056	1342852	180884	90464952	160416
226A1-5M012	181589	1208040	150173	1450156	160197	90509271	070203
226A1-5W900	181591	1208045	150173	1450174	160197	90510089	160549
226A1-5Y700	181589	1208048	150187	1450182	160197	90529673	181495
226A1-67U02	181589	1208053	150262	1605130	150061	90543282	181495
226A1-8J100	181589	1208054	150196	1845089	160879	91159996	150505
226A1-8U700	181590	1208057	150173	1845110	160879	9150494480(2)	150055
226A1-AM601	181591	1208063	150403	1845786	160548	9150633880(2)	150055
226A1-AR210	181591	1208070	150196	1845789	160549	9158718	181590
23750-00QAH	150404	1208071	150278	1845790	160549	9202575	181590
25012-4A00A	181591	1208074	150379	1845791	160549	9202577	181590
25080-89907	180916	1208241	150056	22127653	160197	9287211	160311
25230-89978	160480	1208243	150098	24402859	181592	97532831(2)	150055
25240-89911	180641	1208246	150056	24403860	181592		
25240-89915	180657	1208248	150055	25133391	181584	OSRAM	
25240-89920	180657	1208306	150524	25163613	181584	1157	170724
25240-G2400	180657	1208307	150521	25164596	181584	2321MFX	171379
25320-01B00	180755	1208370	150519	4401810	180905	2322MFX	171380
253200B000	180755	120865	150519	4402309	181064	2351MFX6	171381
25320-0B000	180755	1211560	150062	4402560	150404	2351MFX6	170727
25320-21P00	180755	1211561	150064	4403839	150505	2351MFX6	171109
25320-75A00	180755	1211582	150063	4409990	160795	2352MFX6	170756
26350-G9801	160276	1211591	150063	4506156	160795	2352MFX6	171110
28810-G9708	160395	1237306	150173	4772216	180808	2452MFX6	171023
28810-G9709	160396	1237334	150380	592790	150055	2473MFX6	171033
32005-70E00	181219	1237464	150380	594502	150055	2721	170410
32005-70E10	181219	1237504	150063	594503	150055	2721	170775
32005-70E12	181219	1237539	150387	594531(2)	150055	2721MF	170357
3200570E20	181219	1238228	150485	594533(2)	150055	2721MF8	170612
32005-70E20	181219	1238358	150361	594539(2)	150055	2721MF8W	170545
32005-K1000	181172	1238532	160416	594548	150055	2721MFX	171382
32005-K1002	181172	1238537	160416	594560(2)	150055	2721MFJF	171384
32005-K1004	181172	1238539	160295	6237752	150062	2721MFX	171024
32005-K1014	181172	1238540	160295	6237753	150063	2722MF	170610
32005M0200	181172	1238542	160352	6237754	150064	2722MF8	170611
32005-M0200	181172	1238549	160295	6237777	150175	2741	170477
36531-PNB014	181591	1238550	160297	6238109	150468	2741	171108
98831-6F720	181584	1238563	160352	6238179	181395	2741MF	170358
B2690-12P01	181585	1238565	160416	6238317	180875	2741MF8	170613
B2690-30R00	181584	1238566	160352	6238377	150485	2741MFX	171028
B26A0-67U01	181589	1238621	160311	6238422	181395	2820	170725
PRW1A	150221	1238788	180557	6238927	180557	2820	171121
PRW2	150221	1238966	160295	6239112	181185	2821	170331
PRW2A	150221	1239064	181185	8 55 305	181584	2821	171104
		1239250	181185	8 55 315	181584	2825	170347
		1239260	181150	8 55 333	181584	2825	171105
		1239266	181182	8 55 389	181590	2825L	170662
		1239267	181202	815004	070053	2827	170754
		1239271	181182	815005	070053	2840	171027
NORTHWEST		1239427	180801	815011	070053	2841	170476
889-HO	210892	1239433	180753	815701	180557	2841	171106
889-HS	210891	1240552	180753	826924	180317	2845	170542
889-NT	210846	1240559	180753	90006499	150098	2845	171107
889-XO	210894	1245789	160549	90020443	070053	3757	170711
				90040992	160416	3796	170345

OE No.	HC-CARGO	OE No.	HC-CARGO	OE No.	HC-CARGO	OE No.	HC-CARGO
3796	171103	64193SUP	171066	9004	170692	1628A4	180421
3797	170416	64196	170348	9005	170693	1628L1	180317
3797	170796	64196	170792	9006	170694	1628L4	160424
3799	171483	64199	170006	9006XS	171794	1920.W9	180645
3860	170580	64210	170720	9145	171036	19204S	180557
3892	171492	64211	171037	94196	170450	19208S	150481
3893	170346	64212	171034	94196	171125	1920C3	150343
3893	170774	64213	171035	9507	170849	1920J7	180559
3894	170594	64215	170800	9507	171090	1920W9	150343
3895	171491	64215	171080	9511	170451	1920Z4	180317
3896	171490	64215L	171532	9511	171078	2257.17	181152
3898	170448	6423	170414	9627	170455	2257.22	181156
3898	171119	6423	171096	9627	171118	2257.33	181201
3899	170456	6424	170415	9637	170454	2257.34	181194
3930	170417	6424	171099	9637	171076	2257.40	181194
3930	170795	6428	170590	9930	170503	2257.41	181201
5001	171480	6429	170475			225734	181194
5006	171481	6429	171100	PEUGEOT		225740	181194
5007	170340	6439	170591	0242.12	181005	225741	181201
5007	170773	6450	171489	0242.14	180810	33781405324	181588
5007L	170660	6451	170342	0242.18	180950	4534.02	180731
5008	170339	6453	170592	0242.26	180954	4534.06	180726
5008	170772	6457	170643	0242.30	180953	453411	180785
5008L	170663	6461	170411	0242.33	180951	453421	180785
5407	170593	6461	171095	0242.36	180950	453426	181358
5626	170482	6475	170588	0242.37	180951	5422483	180732
5626	171102	6476	171139	0242.43	180953	5471660	070053
5627	170413	6480	170589	0242.46	180875	591881	150343
5627	170794	66042	171613	0242.49	180954	591887	150343
5631	170584	66050	171132	0242.50	180859	592789	150058
5637	170351	66140	171613	0242.68	180937	594525	150055
5637	170793	66144	171613	024246	180875	594531	139593
6253	170580	66154	171683	024268	180937	594533	150055
64070	170493	66240	171133	1131.14	180645	594539	150055
64070	171068	7135	170816	1131.45	180645	594545	150057
6411	170344	7225	170644	1131.98	180689	594554	150379
6411	171098	7225	171093	113114	180645	594555	150057
64111	170470	7231	170337	113145	180645	594560	150055
64113	170502	7234	171531	113198	180689	594607	180557
64115	170380	7240	170673	1192.W5	181495	594609	180557
64122MF	170751	7241	170337	1264.03	181008	5970.80	150520
64124MF	170752	7244	170453	1264.04	181009	597010	150395
6413	170343	7301	170579	1264.13	181009	597011	150395
6413	171097	7309	170575	1264.14	181008	597026	150395
64132	170741	7326	170814	1264.26	181076	597042	150184
64132	171082	7327	170815	1264.37	181076	597043	150183
64136	170742	7351	170573	1264.40	181076	597045	150247
64136	171083	7360	170574	126403	181008	597048	150259
64138	171084	7429	170507	126404	181009	597049	150260
64149	170696	7429	171088	126406	181104	597053	150252
64150	170069	7430	170583	126413	181009	597077	150506
64150	170332	7501	171475	126414	181008	597078	150522
64150ALL	170722	7506	170335	126416	181104	597079	150522
64150SUP	170965	7506	170769	126426	181076	5974555	150057
64150SUP	171070	7506L	170658	126431	181093	598110	160423
64151	170070	7507	171089	126432	181089	598111	160424
64151	170333	7507	170648	126437	181076	598113	160423
64151ALL	170723	7507LDA	171371	126440	181076	598115	160424
64152	170493	7511	170349	126443	181093	598116	160431
64153	170496	7511	170826	1338.09	180867	598119	160432
64155	170449	7512	170481	1338.10	181373	598120	160431
64155	171072	7512A	170481	1338.55	181373	598121	160436
64156	170412	7517	171476	133809	180867	598124	160434
64156	170836	7526	171472	133850	180875	598126	160436
6416	171488	7527	170586	133857	180875	598127	160436
64173	170576	7528	170336	1338C7	181395	598131	160453
64173	171073	7528	170770	145059	070053	6434.60	160629
64175	170478	7528L	170659	145070	070054	644178	160565
64175	171074	7529	170482	145205	160354	644193	160561
6418	170341	7533	170582	1618.V3	181591	644195	160518
6418	171094	7535	170761	1625.09	181584	6441G4	160561
64183	170681	7537	170452	1628.58	181584	6441L0	160562
64185	170718	7537	171092	1628.7R	181589	655117	160308
64191	170572	7569	170577	1628.J4	181589	6552W5	181358
64193	170334	7582	170581	1628.KN	181590	655504	160308
64193	170768	7597	170614	1628.KP	181591	655522	160353
64193	170804	7669	170578	1628.L4	181589	655533	160282
64193GP	171114	7950	171477	1628.LP	181590	655547	160354
64193L	170657	7951	170338	1628.NY	181590	75454205	181156
64193L	171113	7951	170771	1628.AA	181589	75491289	181156
64193SUP	170804	7952	170350	16281E	180317	75513845	150058

OE No.	HC-CARGO	OE No.	HC-CARGO	OE No.	HC-CARGO	OE No.	HC-CARGO
PEUGEOT continued							
7700591730	181152	9636997880	150520	12458	170718	13258	170449
7910013785	180950	96381671	192902	12475	170681	13258	171072
7910014016	180950	9639912580	160453	12496	170648	13311	170478
7910014017	180950	9752287580	150055	12496	171089	13311	171074
7910033931	180731	97522876	150055	12496SV	171371	13324	170614
7910035100	150055	97530125	150055	12498	170335	13336	170412
7910035225	181584	9753012580	150055	12498	170769	13336	170836
7920076593	160423	97530780	150183	12498LL	170658	13342	170348
91 517 978	181584	97531206	150184	12499	170336	13342	170792
91000409	160354	9753130180	150057	12499	170770	13342GO	170721
9100040980	160354	97531304	150057	12499LL	170659	13342HD	170450
91040130	180645	9753130480	150057	12500	170337	13342HD	171125
91504912	150055	97531922	150055	12503	170673	13401	170480
9150491280	150055	97532831	150055	12516	170410	13401	171086
9150494480	150055	9753283180	150055	12516	170775	13402	170507
9150633880	150055	97533831	150055	12569	170009	13402	171088
91514046	181008	9999163554	160354	12569	171065	13413	170938
9151404980	070053	E144001	181589	12593	170572	13421	170483
91514549	180875	E144003	181590	12594	170644	13422	170481
91514733	181152	E144004	181592	12594	171093	13445	170761
9151586980	160424	E144005	181584	12596	170071	13454	170494
91517505	180859	E144008	181586	12597	170612	13496	170849
91517978	181584			12598	170357	13496	171090
9151797880	181584	PHILIPS		12600	170610	13498	170349
9151819080	070054	1157	170724	12601	170611	13498	170826
9151819380	181585	12023	170470	12602	170611	13498HD	170451
91519272	180954	12025	170380	12604	170610	13498HD	171078
91521113	180645	12027	171124	12605	170357	13499	170452
9153571880	181585	12036	170741	12605	170610	13499	171092
9153880680	070053	12039	170591	12620	170338	13500	170453
9153880780	070054	12040	170948	12620	170771	13516	170477
91541882	160354	12052	170822	12718	170814	13516	171108
9250883280	160423	12060	170726	12728	170815	13521M	170358
9250888280	160423	12064	171135	12748	170573	13593	170360
92515667	160424	12065	170777	12803	171139	13597	170613
9251586780	160424	12066	170776	12807	170588	13598	170358
9251586980	160424	12188	171869	12814	170339	13620	170350
94531104	150057	12227	170575	12814	170772	13628	170362
9453130480	150057	12241	170577	12814LL	170663	13748	170574
9456130480	150057	12247	170579	12818	170590	13807	170589
95 494 924	181584	12256	170331	12819	170580	13814	170351
9549299580	160423	12256	171104	12821	170340	13814	170793
95493258	181015	12258	170069	12821	170773	13814HD	170454
95493608	180951	12258	170332	12821LL	170660	13814HD	171076
9549360880	180951	12258	170332	12822	170593	13821	170413
95494332	180732	12258AW	170722	12829	170448	13821	170794
95494924	181584	12258BV	171071	12829	171119	13821HD	170455
95495591	180953	12258PR	170965	12844	170341	13821HD	171118
95496621	160353	12258PR	171070	12844	171094	13822	170482
95534787	160423	12258VP	171136	12850	170342	13822	171102
95579683	180953	12311	170576	12854	170411	13829	170456
95581212	180810	12311	171073	12854	171095	13844	170414
95630939	181104	12325	170581	12860	170005	13844	171096
95635573	180859	12336	170070	12864	170343	13850	170592
95658442	160518	12336	170333	12864	171097	13864	170415
96010513	150183	12336AW	170723	12865	170005	13864	171099
9601329480	160354	12342	170334	12866	170344	13866	170475
96018108	181201	12342	170768	12866	171098	13866	171100
96018110	181194	12342	170804	12875	170509	13910	170474
96018422	180937	12342BV	171067	12886	170951	13913	170416
96018426	180867	12342GO	171114	12886	171953	13929	170417
96033248	181373	12342GOLD	171114	12894	170726	13929	170795
9603682780	181589	12342LL	170657	12910	170594	13929HD	170503
96040821	180785	12342LL	171113	12913	170345	13961	170542
9604807080	150098	12342PR	170804	12913	171103	13961	171107
96053749	160431	12342PR	171066	12929	170346	13972	170800
9607312	150379	12342VP	171134	12929	170774	13972	171080
96073612	150379	12356	170742	12960	170725	13972LL	171532
9607361280	150379	12356	171083	12960	171121	24356	171084
96117510	160431	12396	170754	12961	170347	6336	171469
96123564	181064	12396	171123	12961	171105	6402	171470
96138637	181076	12401	170582	12961LL	170662	6421	171471
96141677	160432	12402	170583	12972	170720	6445/99	171472
96165823	160436	12413	170584	12972	171077	6458	171473
9616582380	160436	12421	170560	12972BV	171079	6498	171475
96165824	160434	12422	170585	12972LL	171117	6499	171476
9616582480	160434	12428	170696	12972PR	171081	6620	171477
9619879180	160570	12445	170586	12972VP	171137	6807	171479
96252036	160432	12454	170493	13241	170578	6811	171484
9635864980	150522	12454	171068	13256	170476	6814	171480
9635884880	150522	12455	170496	13256	171106	6821	171481

OE No.	HC-CARGO	OE No.	HC-CARGO	OE No.	HC-CARGO	OE No.	HC-CARGO
6828	171482	16010892	150063	7700728638	150340	ROVER GROUP	
6829	171483	16015130	150061	7700729063	181584	73365A	180359
6849	171485	16017433	150062	7700729963	181584	AUU1649	070053
6850	171486	1875990	150058	7700732263	150229	BAU2445	181148
6854	171487	1894322	150058	7700732506	181152	BAU5332	150055
6864	171488	1975617	150061	7700733390	160429	DPB9171	150097
6866	171489	1976908	150061	7700737571	180905	ERR6045	150252
6910	171490	1978778	150062	7700739793	150340	ERR6566	150252
6913	171491	1987465	150239	7700739794	150340	ERR6729	180359
6929	171492	1987466	150239	7700749146	150229	ERR7171	181500
7779	171027	1988500	150061	7700751089	160425	GAE191	181165
85122	171133	1989747	150239	7700757776	160425	GAE191A	181165
85126	171132	3474232	150187	7700771786	180963	GCL195	150270
85410	171613	7033103	150064	7700778780	181191	GCL201	150432
9004	170692	7954117	180660	7700778783	180928	GPS101	180649
9005	170693	830931	150058	7700782503	181064	GPS124	180638
9006	170694	93488922	150058	7700786460	180963	GPS126	180649
		9348922	150058	7700786466	180928	GPS126	180649
		D1906	150058	7700790579	160438	GPS131	180649
PIAGGIO		D1948	150061	7700796048	181064	GPS133	180649
639523	181584	D1951	150064	7700802640	181191	GPS137	180634
		D1952	150061	7700851443	160438	GPS138	180645
PORSCHE		D1956	150061	7700852093	150229	GPS178	180638
043906091	070053	D1957	150063	7700852093	150232	GPS184	180638
191905351A	150075	D1958	150063	7700852662	150229	GTR184	180832
90161357101	180634	D1959	150062	7700855358	070053	GTR204	180875
91109417700	181584	D1961	150063	7700856789	160438	GTR210	180910
91160612300	181584	D1963A	150061	7700863020	150429	H CJ100110	160436
92860270601	150098	D1968	150061	7700863021	150430	MEK100120	180910
92860612301	181584	D1978	150239	7700863454	160438	MHK 000210	181588
92860612400	181585	D1979	150239	7700863626	160439	MHK 000220	181588
92860612800	181585	D1980	150239	7700864987	181585	MHK 10023	181584
92860612801	181585	D1990	150239	7700866727	160451	MHK 100920	181588
92860810401	070054	D1993	150239	7700867374	160438	MHK 100930	181588
92860810402	070054	SU31	180808	7700867408	181590	MHK 100940	181588
92862817200	160197			7700867558C	160461	MHK 500860	181591
93060612400	181585	RENAULT		7700869343	180905	MHK000060	181592
93160620600	181584	5000409614	160417	7700870715	160452	MHK000230	181500
94460612500	180875	6001008001	070053	7700870715A	160452	MHK10004L	181589
94460613300	181584	7401269084	150056	7700870715B	160452	MHK10023	181584
94460613500	181585	7401271939	181588	7700875000	150505	MHK100650	181590
94460613501	181585	7401275174	150226	7701021955	150058	MHK100722	181590
94460613502	181585	7439146108	150496	7701031135	150185	MHK100800	181500
94460810200	070054	7700100589	150415	7701034407	180317	MHK100960	181584
94460810201	070054	7700100643	150434	7701041607	150429	MHK101070	181495
94460810203	070054	7700101968	181397	7701041608	150430	MHK101280	181584
94460810204	070054	7700101969	150414	7701041608	180317	MHK500860	181591
94460810205	070054	7700101970	150404	7701047921	180317	MVK10002	180884
94460810206	070054	7700102036	160439	7701348194	181008	NCJ100110	160436
95160613500	181585	7700103069A	150404	7701348716	181152	NEC100630	150432
96460612401	181586	7700107177	150505	7701348734	160438	NJL100030	150236
96560612600	181585	7700107269	150419	7701348772	180950	NJL100040	150236
96560612601	181585	7700107794	160461	7701349086	180810	NJW1000030	150236
98660612600	181588	7700108073	150460	7703597062	192902	PEJ10007	180937
98660612601	181588	7700109860	160718	770852093	150232	PEL100230	180832
98660612701	181588	7700111525	160719	8200051128	150441	PRC1039	181183
98660612801	181588	7700113357	150505	8200052063	181590	PRC5020	160424
99360270600	150379	7700113357A	150505	8200084401	150441	PRC7062A	180359
99360611600	181588	7700115078	160795	8200154186A	150505	RTC4512	181183
99360611601	181588	7700260678	070054	8200156569	192998	TKC6761	181165
99360611800	181588	7700267774	070054	8200208611	150505	UMB10001	181194
99360611801	181588	7700273273	181585	8200208611	150505	UMB10003	181212
99360612600	181588	7700273715	181585	8200468645	150404	UMB100050	181194
99360612601	181588	7700274008	150433	8200568671	150505		
99360612700	181588	7700414988	181367	8933000153	180557	SAGEM	
99360612800	181588	7700503200	180810	8933002455	181584	2526051A	150429
99360612801	181588	7700582688	180874	9611751080	160431	2526052A	150430
99660611800	181588	7700590793	160316	9632889780	150481	2526110A	150429
		7700670255	181584	9633001580	150506	2526111A	150430
		7700681024	181584	TO 70 895 5	181584	2526114A	150415
PVL		7700687710	070053			2526115A	150434
101-500	150250	7700702747	160425	ROLLS ROYCE		2526151A	150433
		7700706876	180557	PB20364	181588		
REMY (DELCO)		7700708605	181584	UE73879	181589	SAW	
10496048	150239	7700708955	181584	UE74940	181590	10.115-171	171167
10496541	150239	7700708960	160352	UR22163	181584	10.115-411	170851
10496784	150239	7700715675	160352	UR26474	181584	10.185-021	171168
13010888	150065	7700721268	160354	UT 0095	181588	10.190-011	170857
13010892	150063	7700722070	150229	UT0095	181588	14.115-011	170865
13017433	150062	7700722393	070053	UT10094	181588	14.129-011	170867
15-8345	160250	7700728637	150340			20.017-001	171171
16010888	150065						

ACCESSORIES

O. E. M names and numbers are used for reference purposes only

OE No.	HC-CARGO	OE No.	HC-CARGO	OE No.	HC-CARGO	OE No.	HC-CARGO
SAW continued				STRIBEL			
20.017-041	171173	90.017-081	171242	008-A100-93D	160593	896399	160401
20.017-171	171174	90.026-001	171244	008-A45-02	160483	898151	160401
20.017-181	171175	90.032-021	171250	008-B45-02	160649	898160	160400
20.022-001	171178	90.032-031	171250	009-A22-26D	160592	898174	160470
20.022-011	171179	90.086-021	171252	009-A70-74D	160592	898211	160466
20.022-021	171180	90.093-011	171253	009-B40-22	160594	898244	160353
20.024-001	170875	90.104-001	170975	010-A70-74D	160639	898326	160400
20.026-001	171181	90.104-011	170976	010-B70-74D	160596	898416	160470
20.026-021	171182	90.111-001	171258	VA01-BP70/LL-36A	160584	898797	160792
20.026-031	171183	90.111-011	171259	VA01-BP70/LL-36A	161004	899019	160416
20.104-031	170880	90.131-001	170989	VA01-BP70/LL-36S	160908	899020	160416
20.104-041	170881	90.131-081	170944	VA04-AP70/LL-37A	160885	899028	160469
20.131-051	170882	90.147-021	171263	VA04-AP70/LL-37S	160912	899030	160419
20.196-001	170884	90.199-001	171264	VA07-AP12/C-31A	160537	899045	160419
20.196-021	170885	90.199-011	171265	VA07-AP12/C-58A	160537	899046	160419
20.196-031	170886	95.009-061	171266	VA07-AP12/C-58S	160910	899047	160419
20.196-041	170887	95009-061	171266	VA07-AP7/C-31A	160537	899047	160419
21.001-021	171188	SCANIA		VA07-AP8/C-58A	160537	899102	160416
21.001-031	171189	1350343	170968	VA07-BP12/C-58A	160799	899107	160420
21.001-071	171190	1365963	170916	VA07-BP12/C-58S	160597	899108	160444
21.002-021	170893	1365964	170917	VA07-BP7/C-31A	160906	899117	160458
21.002-031	170893	1365965	170917	VA07-BP7/C-31S	160588	899121	160416
21.002-071	170895	1365965	170917	VA08-AP51/C-23A	160914	899123	160444
21.008-041	171191	2573826	150056	VA08-AP51/C-23S	160915	899125	160416
21.010-041	171192	3200423	181588	VA08-BP51/C-23A	160909	899132	160418
21.010-051	171193	4239489	181588	VA08-BP51/C-23S	160909	899136	160421
21.010-101	171194	4301552	181588	VA09-AP12/C-27A	160598	899138	160419
21.010-111	171195	4302352	181588	VA09-AP12/C-27S	160601	899139	160421
21.010-121	171328	4302360	181588	VA09-AP12/C-54S	160601	899149	160448
21.010-131	171329	4395612	070203	VA09-AP8/C-27A	160598	899151	160445
21.017-121	171196	4660171	181588	VA09-AP8/C-27S	160601	899152	160447
21.026-011	171197	4660197	181588	VA09-BP12/C-27A	160599	899153	160446
21.086-031	171199	4660205	181588	VA09-BP12/C-27S	160600	899169	160422
21.086-051	171201	SEV		VA09-BP12/C-54S	160600	899176	160417
21.093-021	171202	73503702	150055	VA09-BP50/C-27A	160599	899179	160441
21.111-001	171203	SIEM		VA09-BP50/C-27S	160600	899180	160443
21.111-011	171204	05879900	160423	VA09-BP8/C-27A	160599	899189	160416
21.131-001	170943	06421900	160424	VA09-BP8/C-27S	160600	899195	160442
21.147-071	171205	08110900	160425	VA10-AP10/C-61A	160538	899202	160654
21.147-081	171206	SIEMENS		VA10-AP10/C-61A	161002	899203	160654
21.176-001	170912	17-5607	150055	VA10-AP10/C-61S	160536	899626	160337
21.176-011	170913	257612.70-01	150056	VA10-AP10/C-61S	161003	899627	160308
21.195-001	171209	5WK0611	150278	VA10-AP9/C-25A	160538	899628	160308
21.195-011	171210	5WK1636	160297	VA10-AP9/C-25A	161002	899744	160308
21.197-001	170916	5WK1640	160297	VA10-AP9/C-25S	160536	899747	160337
21.197-011	170917	5WK2205	160374	VA10-AP9/C-25S	161003	899784	160337
21.197-021	170916	5WK6101	150056	VA10-BP10/C-61A	160584	899798	160337
21.197-031	170917	5WK6102	150075	VA10-BP10/C-61A	161004	899839	160337
21.197-111	170923	5WK6105	150056	VA10-BP50/C-25A	160584	899932	160394
21.197-121	170922	5WK6113	150154	VA10-BP50/C-25A	161004	899957	160394
21.197-131	170923	5WK6208	150380	VA10-BP50/C-61S	160737		
21.199-001	171213	5WK6222	150175	VA11-AP7/C-29A	160539	SUBARU	
21.199-011	171214	PM3511	160250	VA11-AP7/C-29A	161000	18213-60B00	181584
22.026-171	171215	PM3789	160528	VA11-AP7/C-57A	160539	18213-61A10	181584
22.028-091	170925	S100620003	150293	VA11-AP7/C-57A	161000	21203-AA000	180827
22.093-041	171216	S102020001C	150229	VA11-AP7/C-57S	160911	22641-AA501	181590
22.111-001	171217	S102020001C	150232	VA11-AP8/C-57A	160539	22690-KA000	181584
22.111-011	171218	S102030002A	150229	VA11-AP8/C-57A	161000	22690-KA000	181584
22.111-041	171217	S102030002A	150232	VA11-BP12/C-57A	160587	22690-KA020	181584
22.130-001	171006	S105548001E	150414	VA11-BP12/C-57A	161001	22690-KA060	181584
22.131-011	170927	S105757001E	150404	VA11-BP12/C-57S	160714	22690-KA080	181584
23.030-051	170928	S105757001Z	150404	VA11-BP7/C-29A	160587	22690-KA081	181584
23.033-001	170929	S107306001A	150460	VA11-BP7/C-29A	161001	22690-KA092	181584
23.056-011	170930	S119975001B	150404	VA14-BP7/C-34A	160998	22690-KA151	181584
23.093-001	171219	SOLEX		VA14-BP7/C-34S	160999	22690-KA171	181584
23.191-001	171220	16070007	180559	VA15-BP70/LL-39A	160907	22690-KA180	181584
24.030-051	170932	SPAL		VA18-BP10/C-41S	160595	22690-KA210	181590
24.033-001	170934	005-A45-02	160510	VA18-BP51/C-41S	160595	22690-KA211	181590
24.033-031	171222	006-A46-22	160647	VA18-BP70/LL-41A	160777	22690-KA212	181590
24.056-001	170935	006-A54-22	160511	VA18-BP70/LL-41S	160595	22690-KA221	181591
24.056-011	170935	006-B40-22	160557	VA18-BP70/LL-86A	160777	22690-KA250	181591
25.011-021	171224	006-B40-22/4	160878	VA18-BP70/LL-86S	160595	22690-KA251	181591
25.012-011	170936	006-B46-22	160556	VA18-BP71/LL-86A	160777	22690-KA251	181591
25.087-001	171225	006-B50-22	160512	VA34-AP70/LL-36A	160739	22690-KA330	181590
80.085-001	171226	SSANG YONG		VA34-AP70/LL-36S	160913	22690-KA331	181590
80.091-001	171228	0000940548	181500	VA34-AP70/LL-36S	160619	22690-AA000	181584
80.091-021	171230	0001587003	150424			22690-AA020	181584
80.143-021	171233	0001587503	150424			22690-AA030	181584
90.008-101	171236					22690-AA031	181584
90.010-031	171237					22690-AA040	181584
90.010-051	171237					22690-AA050	181584
						22690-AA120	181584

OE No.	HC-CARGO	OE No.	HC-CARGO	OE No.	HC-CARGO	OE No.	HC-CARGO
22690-AA213	181585	18213-57B10000	181584	18213-65D72000	181591	18213-86G11	181591
22690-AA220	181585	18213-58B00	181590	18213-65G00	181590	18213-86G11000	181591
22690-AA220F	181585	18213-58B00000	181590	18213-65G00000	181590	18213-86Z00	181591
22690-AA320	181585	18213-58B10	181590	18213-65G10000	181591	18213-86Z00000	181591
22690-AA321	181585	18213-58B10000	181590	18213-65G31	181591	18213-86Z01	181591
22690-AA370	181585	18213-58B11	181590	18213-65G31000	181591	18213-86Z01000	181591
22690-AA380	181590	18213-58B11000	181590	18213-65H00	181591	33370-641311	150377
22690-AA38A	181590	18213-58B20	181585	18213-65H00000	181591	33370-64B11	150377
22690-AA43A	181590	18213-58B20000	181585	18213-67D00000	181590	33370-82032	150160
22690-AA45C	181590	18213-58B21	181590	18213-67D10	181591	33410-52012	150395
22690-AA490	181590	18213-58B21000	181590	18213-67D10000	181591	33410-64810	150275
22690-AA491	181590	18213-58B30	181584	18213-67D30	181590	34850-65011	180811
22690-AA500	181590	18213-58B30000	181584	18213-67D30000	181590	34850-70B10	180832
22690-AA501	181590	18213-58B40	181591	18213-67H01	181591	37820-73000	180641
22690-AA510	181591	18213-58B40000	181591	18213-67H01000	181591	37820-79600	180641
22690-AA520	181590	18213-58B41	181591	18213-67H10	181591	37820-82000	180641
22690-AA53B	181590	18213-58B41000	181591	18213-67H10000	181591	37820-82001	180638
22690-AA560	181590	18213-58J10	181591	18213-68H00	181591	38610-85C00	160315
22690-AA56A	181590	18213-58J10000	181591	18213-68H00000	181591		
22690-AA590	181591	18213-60B00000	181584	18213-68H10	181591	SWF	
22690-AA610	181591	18213-60E60	181584	18213-68H10000	181591	116181	160815
22690-AA650	181591	18213-60E60000	181584	18213-68H51	181591	402227	160031
22690-AA670	181591	18213-60G00000	181590	18213-68H51000	181591	402230	160032
22690-AA68A	181590	18213-60G01	181590	18213-70H00	181590	402231	160034
22690-AA690	181591	18213-60G01000	181590	18213-70H00000	181590	495299	SW126
22690-AA69A	181590	18213-60G10000	181591	18213-70H01	181590	511005	180206
22690-AA700	181591	18213-60G11	181591	18213-70H01000	181590	511006	180207
22690-AA70A	181590	18213-60G11000	181591	18213-70H02	181590	596615	181463
22690-AA73A	181590	18213-60G20	181591	18213-70H02000	181590	596650	181462
22690-AA810	181590	18213-60G20000	181591	18213-73B00	181584	611012	160316
22690-AA81A	181590	18213-60H50	181591	18213-73B00000	181584	611013	160317
22690-AA850	181591	18213-60H50000	181591	18213-74F00	181584	611100	160242
25240-KA050	180638	18213-60H51	181591	18213-74F00000	181584	611101	160244
32005-KA080	181172	18213-60H51000	181591	18213-74F10	181584	611102	160243
37820-82001	180641	18213-61A10	181584	18213-74F10000	181584	611107	160305
42995-5500	180638	18213-61A10000	181584	18213-76G00	181584	611108	160305
42995-7000	180641	18213-62J01	181590	18213-76G00000	181584	611111	160315
46979-7000	181584	18213-62J01000	181590	18213-76G50	181591	611112	160315
46979-7100	181584	18213-63A00	181584	18213-76G50000	181591	611114	160262
46979-7110	181584	18213-63A00000	181584	18213-76G51	181591	611115	160199
49146-7401	150091	18213-63E60	181584	18213-76G51000	181591	611116	160315
82080-4150	180827	18213-63E60000	181584	18213-77E11	181591	696289	180208
82988-4100	150395	18213-63F00	181584	18213-77E11000	181591	896426	180209
82988-4112	150395	18213-63F00000	181584	18213-78A01	181584	896472	180210
82988-6111	150395	18213-63J01	181591	18213-78A01000	181584		
82995-6100	180641	18213-63J01000	181591	18213-79GA1	181591	SAAB	
82995-6101	180641	18213-63J12	181591	18213-79GA1000	181591	32000152	181588
83311-AA010	180755	18213-63J12000	181591	18213-79GA2	181591	4069985	160791
83311-AA011	180755	18213-64B00000	181584	18213-80G00	181591	4086708	181001
		18213-64D10	181590	18213-80G02	181591	4232666	181182
SUZUKI		18213-64D10000	181590	18213-80G02000	181591	4239042	181585
13650-84101	180914	18213-64D11	181590	18213-80G12	181591	4239489	181588
13650-84110	180914	18213-64D11000	181590	18213-80G12000	181591	4301545	181588
163547	160311	18213-64F00000	181590	18213-82001	181584	4302352	181588
18212-86Z00	181590	18213-65B00	181590	18213-83000	181584	4390266	181585
18212-86Z00000	181590	18213-65B00000	181590	18213-83E01	181591	4395612	070203
18212-86Z01	181590	18213-65D01	181591	18213-83E01000	181591	4570909	181592
18212-86Z01000	181590	18213-65D01000	181591	18213-83E10	181591	4570917	181592
18213-50A00	181584	18213-65D02	181591	18213-83E10000	181591	4571477	181592
18213-50A00000	181584	18213-65D02000	181591	18213-83E11	181591	4617668	181182
18213-50F00	181584	18213-65D10000	181590	18213-83E11000	181591	4660163	181588
18213-50F00000	181584	18213-65D2000	181591	18213-83G00	181590	4660171	181588
18213-50G00000	181591	18213-65D21	181591	18213-83G00000	181590	4660197	181588
18213-50G01	181591	18213-65D21000	181591	18213-83G01	181590	4660205	181588
18213-50G01000	181591	18213-65D30000	181590	18213-83G01000	181590	4660445	181588
18213-50G10	181591	18213-65D31	181590	18213-83G50	181590	4660494	181588
18213-50G10000	181591	18213-65D31000	181590	18213-83G50000	181590	4660502	181588
18213-50G11	181591	18213-65D32	181590	18213-83G51	181590	4660585	181395
18213-50G11000	181591	18213-65D32000	181590	18213-83G51000	181590	4661062	180317
18213-52E00	181590	18213-65D40	181591	18213-84D00	181591	4662359	181588
18213-52E00000	181590	18213-65D40000	181591	18213-84D00000	181591	4758272	160549
18213-54D01	181590	18213-65D41	181591	18213-85Z00	181590	4770228	180875
18213-54D01000	181590	18213-65D41000	181591	18213-85Z00000	181590	4772208	181395
18213-54G00	181591	18213-65D42	181591	18213-85Z1000	181591	4772307	181395
18213-54G00000	181591	18213-65D42000	181591	18213-85Z10000	181591	4773586	181395
18213-56B00	181587	18213-65D43	181591	18213-86G00	181590	5341391	181395
18213-56B00000	181587	18213-65D43000	181591	18213-86G00000	181590	55353148	181592
18213-57B00000	181591	18213-65D50000	181590	18213-86G01	181590	55353149	181592
18213-57B01	181591	18213-65D51	181590	18213-86G01000	181590	5959283	181395
18213-57B01000	181591	18213-65D51000	181590	18213-86G10	181591	7503600	150098
18213-57B10	181584	18213-65D72	181591	18213-86G10000	181591		

OE No.	HC-CARGO	OE No.	HC-CARGO	OE No.	HC-CARGO	OE No.	HC-CARGO
89465-52170	181591	90919-02028	150395	180433-2	190725	GTR115	180808
89465-52180	181591	90919-02030	150395	180984	192002	GTR127	180811
89465-52190	181590	90919-02031	150395	182490-2	191025	IKC6761	181165
89465-52200	181591	90919-02036	150395	183024-1	192089	RTC4512	181183
89465-52250	181591	90919-02037	150395	183025-1	192090		
89465-52280	181591	90919-02042	150395	189727-1	210851	VALEO	
89465-52330	181591	90919-02043	150395	1-963745-1	192156	03283	160337
89465-52360	181591	90919-02046	150395	1-963746-1	192157	03501	160358
89465-52400	181591	90919-02055	150395	1-966867-1	192502	03523	160337
89465-53010	181591	90919-02056	150395	281934-3	192091	03601	160282
89465-53020	181591	90919-02057	150395	282079-2	192078	03608	160311
89465-53060	181591	90919-02058	150395	282080-1	192080	040500	170665
89465-53070	181591	90919-02059	150395	282087-1	192082	067500	170968
89465-53080	181591	90919-02067	150395	282088-1	192084	102180	160423
89465-53090	181591	90919-02070	150395	282089-1	192086	102180M	160423
89465-53100	181591	90919-02076	150395	282090-1	192088	102696	160424
89465-53110	181591	90919-02079	150395	282103-1	192077	105857	160423
89465-53120	181591	90919-02088	150395	282104-1	192079	141500	170602
89465-53130	181591	90919-02092	150395	282105-1	192081	167600	170917
89465-53140	181591	90919-02094	150395	282106-1	192083	167700	170923
89465-53150	181591	90919-02097	150395	282107-1	192085	168100	170922
89465-53190	181591	90919-02098	150395	282108-1	192087	168270	170917
89465-53200	181591	90919-02100	150395	282189-1	192147	168340	170916
89465-53230	181591	90919-02101	150395	282191-1	192148	168350	170916
89465-58010	181591	90919-02102	150395	282192-1	192171	168360	170917
89465-58020	181591	90919-02103	150395	321060	192067	168590	171098
89465-58050	181591	90919-02104	150395	328394	191501	2256009	150184
89465-58060	181591	90919-02105	150395	341001-6	191247	2256023	150185
89465-58090	181591	90919-02109	150395	341002-6	191246	2256026	150247
89465-58100	181591	90919-02111	150395	341352	420043	2256026A	150247
89465-58110	181591	90919-02120	150395	341353	420042	2256030	150243
89465-58120	181591	90919-02121	150395	454100-000	191010	2256035A	150260
89465-60020	181590	90919-02122	150395	5-1579007-2	210644	2256037A	150259
89465-60150	181591	90919-02123	150395	539960-1	210918	2256040A	150259
89465-60200	181591	90919-02125	150395	691091-000	191703	2256048	150185
89465-60210	181591	90919-02126	150395	726506-1	211018	2256049	150196
89465-60220	181591	90919-02128	150395	726518-1	211017	2256055	150278
89465-60230	181591	90919-02163	150266	726534-2	211015	2256055A	150278
89465-60250	181591	90919-02164	150267	825414-5	192146	2256070	150217
89465-60320	181591	90987-02001	160480	825514	210689	2256071	150192
89465-60330	181591	90987-02004	160480	827397-2	191544	245039	150247
89465-60370	181591	90999-99089	160480	827572-1	192149	245040	150259
89465-63010	181591	CYGS0-65A	150157	925176	170799	245042	150196
89465-63030	181591			925306-2	170619	245049	150243
89465-68010	181591	TVR		925596-1	191551	245054	150185
89465-68020	181591	DRG3LS	180359	925597-2	192155	245057	150278
89465-68040	181591	ERR6729(2)	180359	925613-2	191556	245063	150217
89465-68050	181591			925660-1	191563	245094	150506
89465-69125	181585	TYCO		925661-1	191564	245097	150522
89465-80041	181591	0-1414168-0	160394	926893-3	191092	245513	150065
89465-80048	181591	108961-000	191011	926894-1	191091	245514	150072
89465-87108	181584	1-1579007-4	210919	926983-2	191543	245515	150058
89465-87212	181584	1-1579007-6	210921	929938-1	192176	245516	150175
89465-87707	181584	1-1579007-6	210921	929940-1	192175	245518	150074
89465-97212	181590	1-350344-0	191809	967398-000	191009	245519	150056
89465-97405	181591	1-350345-0	191808	E74832-000	191702	245520	150057
89620-10090	150157	1-350346-0	191811	F40876-000	191701	245521	150075
89620-10120	150157	1-350347-0	191810			245522	150062
89620-12340	150157	1-480672-0	191562	UNIPART		245523	150064
89620-14210	150092	1-480673-0	191561	GCE161	150269	245527	150088
89620-16070	150157	151791-2	190726	GCL201	150432	245529	150232
89620-32010	150092	160314-2	190024	GPS101	180649	245531	150171
89620-32020	150092	165008	190973	GPS106	180649	245532	150172
90190-2050	150395	165012	191067	GPS107	180652	245533	150067
90191-02007	150395	170364-1	191915	GPS109	180636	245534	150154
90919-02004	150395	170366-1	191916	GPS116	180652	245537	150165
90919-02006	150395	172127-1	191226	GPS117	180649	245538	150071
90919-02008	150395	172128-1	191227	GPS118	180630	245539	150068
90919-02013	150395	172129-1	191158	GPS124	180638	245542	150092
90919-02014	150395	172130-2	191159	GPS126	180649	245544	150157
90919-02015	150395	172131-1	191224	GPS140	180631	245550	150236
90919-02016	150395	172132-1	191225	GPS141	180636	245551	150160
90919-02017	150395	172158-1	191917	GPS142	180634	245600	160423
90919-02018	150395	172166-1	191918	GPS145	180635	245603	160424
90919-02019	150395	173706-1	192410	GPS146	180634	245604	160425
90919-02020	150395	173707-1	192411	GPS147	180641	245606	160429
90919-02021	150395	175062-1	192786	GPS149	180658	245607	160438
90919-02022	150395	175063-1	192785	GPS150	180630	245609	160431
90919-02024	150395	179461-5	192381	GPS153	180645	245612	160431
90919-02026	150395	179462-3	192380	GPS155	180657	245615	160420
90919-02027	150395	180422-2	191938	GPS158	180665	245618	160432

OE No.	HC-CARGO	OE No.	HC-CARGO	OE No.	HC-CARGO	OE No.	HC-CARGO
VALEO continued							
2528001	150176	CD871	150064	020941521A	181148	037906265F	181585
2528001A	150176	CD873	150088	020945415A	181212	037906265G	181585
2528007	150057	CD875	150232	021 906 265	181589	037906265H	181585
2528008	150055	CD877	150171	021905106	150516	037906265S	181586
2528008A	150055	CD878	150172	021905106A	150516	037906433A	150445
255041	150260	CD879	150067	021906265	181589	037906433B	150445
2595001	150065	CD880	150154	021906265A	181284	037906433C	150445
2595002	150072	CD883	150165	021906265AB	180485	037919369	180986
2595003	150058	CD885	150065	021906265AD	181588	038906461	181491
2595005	150074	W962011T	160511	021906265AF	181588	038906461B	181491
2595006	150055			021906265AH	180485	038919081A	180688
2595007	150056	VARTA		021906265AL	181588	039 906 265	181584
2595008	150057	V357	200779	021906265B	181586	039906265	181584
2595009	150075	V625U	200778	021906265BN	181588	03D905115A	150513
2595010	150062			021906265E	180485	03D905115B	150513
2595011	150064	VDO		021906265N	181284	03D905115C	150513
2595013	150088	246.042	160197	021906433E	150453	03D905115E	150513
2595016	150175	246001	160197	021919081	180634	03D905115F	150513
2595017	150176	246075	160197	021919081A	180634	03D905115G	150513
2595018	150232	246083002006G	160381	021919081B	180634	043905115A	150395
2595020	150171	246083002014G	160382	021919081C	180635	043906091	070053
2595021	150172	3732836001V0	160548	023 906 262	181592	045906461	181491
2595022	150067	801003061	180841	023906205H	181585	047919081A	181340
2595023	150154	804/006/005	180839	023906265D	180485	048 906 265	181585
2595026	150165	805/34/001	180897	023906265H	181585	0489051051	150252
2595027	150071			025 906 265	181584	049062651	180485
2595028	150068	VEGLIA		025906041	180875	049919501	180839
2595031	150092	06459169917	180631	025906041A	180861	0499195011	180839
2595033	150157	0968012	180950	025906265	181584	050 906 265	181584
509730	160548	1.164.5108.990.2	180702	025906265B	181587	050906265	181584
643817	160453	1.164.5111.990.3	180704	0269061612	180919	051906265E	181584
698032	160565	1.164.5911.990.1	180634	0269190811	180635	052905105	150395
698046	160518	1.164.5916.991.7	180631	027919501	180839	053919369A	180988
698080	160590	1.164.5916.992.5	180631	028906461	181496	054919369B	180988
698192	160561	1.164.5916.992.6	180630	028919081A	180634	056919081B	180635
698215	160621	1.165.8045.990.4	180945	028919081B	180634	056919081C	180658
698216	160620	1.165.8067.990.4	181021	028919081D	180694	058905101	150428
698381	160631	1.165.8072.990.1	181001	028919501A	180807	058905105	150428
698448	160562	1.165.8072.990.8	181009	02K945415	181456	058906265V	181592
698806	160879	1.165.8072.991.3	181005	02K945415D	181456	059906461A	181497
73100122	160423	1.165.8073.990.2	181009	02T945415	181456	059906461B	181491
73101002	160423	1.165.8073.992.7	181005	030 906 265	181585	059906461E	181497
73103402	160424	10802	180702	030906265AP	181586	059906461EX	181497
73104822	160425	1103	180704	030906265BF	180485	059919081	180634
73104902	160431	11103	180704	030906265BG	180485	059919501A	181400
73105002	160424	1601	180631	030906265BJ	180485	061919081	180634
73506302	160431	1605	180630	030906265BK	181588	068919081A	180688
73506802	160453	2501	180689	030906265BR	180485	06A904461L	181491
73507202	160432	4001	180804	030906265F	181585	06A905115	150508
819745	181064	4504	180945	030906265G	181585	06A905115A	150508
819749	181009	6450099901	180704	030906265P	181585	06A905161B	150495
819752	181076	6450119903	180704	030906265R	181586	06A905161C	150495
819757	181008	6451119903	180704	030906265S	181284	06A906262AK	181592
819758	181005	6593339900	180805	032905106	150435	06A906262AL	181592
819759	181001	6704	181021	032905106B	150435	06A906262AS	181592
819772	181104	7002	180805	032905106D	150435	06A906433C	150453
819774	181021	7003	180804	034905381	150360	06A906433K	150470
819784	181065	7202	180805	034905381A	150360	06A906433L	150470
819785	181070	7213	181005	034906161	180919	06A906461	181491
CD308	150183	7301(2)	181001	034906265A	181589	06A906461A	181493
CD321	150184	7302	181009	034906265B	181585	06A906461D	181491
CD325	150185	7302(2)	181009	034906265D	181587	06A906461E	181491
CD328	150243	8501	180945	034919369B	180987	06A906461N	181491
CD330	150247			035 906 265	181584	06B133471	181491
CD331	150259	VOLKSWAGEN		035133533A	181584	06B905115	150518
CD338	150196	0003933681	180631	035905381B	150360	06B905115B	150518
CD339	150187	0003940980	180630	035906265	181584	06B905115E	150518
CD440	150278	0003949879	180805	035906265A	181584	06B905115G	150508
CD445	150217	0003961005	181584	035906265C	181584	06B905115H	150508
CD446	150192	0004318331	181001	035919369S	180988	06B905115J	150508
CD604	150057	000VT5077	181491	035919521A	180949	06B905115L	150508
CD605	150176	004050016	150227	036905100A	150509	06C 906 265	181592
CD856	150055	004050104	150227	036905100B	150509	06C906265	181592
CD862	150072	004165019	181284	036905100C	150509	06C906265A	181592
CD863	150058	004435008	180875	036905100D	150509	06C906265E	181592
CD864	150380	004435010	180874	036905715	150509	071906461A	181492
CD866	150074	005566119	181212	036905715A	150509	071906461B	181493
CD867	150056	00A905105	150424	037906265B	181585	074906461B	181491
CD868	150057	01E941521	181194	037906265C	181585	077906262C	181592
CD869	150075			037906265E	181585	077906262G	181592
CD870	150062						

OE No.	HC-CARGO	OE No.	HC-CARGO	OE No.	HC-CARGO	OE No.	HC-CARGO
077906265A	181587	1J0945511A	181369	6K0945515	180757	1317809	150056
077906265AD	181592	1J0959481A	181444	6K0945515A	181356	1317820	150055
077906265AE	181592	1J1819021A	160515	6N0905104	150227	1324750	180660
077906265AF	181592	1J1819021B	160515	6N0951101	160658	13247507	180660
077906265D	181588	1J1819021C	160515	6U0906265B	181284	1326730	160352
077906265E	181588	1J5955651	160379	6U0919501	180875	13323969	180875
077906265H	181592	1J6955651	160683	6U0945515	180726	13325840	150098
077906265J	181592	1J0945511B	181369	6U0945515A	180726	13336679	070054
077906265K	181592	1J0945511C	181369	6U0959481	181126	13363858	180317
077906265L	181592	1J0945511D	181369	6U0959481A	181126	1336679	070054
077906265R	181592	211905115D	150192	701905104	150231	1347003	180665
077906265T	181592	211905351	150056	701905104A	150231	13470034	180665
077906265AA	181592	211905351A	150056	701919369E	180995	1347603	160401
078 906 265	181585	211905351B	150056	701959263A	160762	1348600	160400
078905375	150360	211905351D	150056	7M0906265C	180285	1363438	160458
078905381	150360	211905351E	150056	811906091	070071	1367776	150387
078905381A	150360	251905115A	150192	857951253	160751	1367777	150226
078906265	181585	251906091	070053	867905104	150227	1378123	181587
078906265C	181588	251919501A	180848	867905104A	150227	1378162	180557
078906265F	181588	251919501D	180848	867905105A	150231	1378504	181034
078906265G	181588	251959481G	181121	867905351	150172	13785043	181034
078906265H	181588	251959481K	181121	867905352	150171	1383966	150496
078906265J	181588	251965561B	070192	867906091	070071	13893995	150336
078906265L	181588	2D0955651A	160197	867906091B	070071	1389939	150056
078906265N	181592	3059060591	160352	893819021	160520	1606877	180660
078906265P	181592	311919081A	180634	893820021	160513	16068777	180660
078906265T	181592	312939030	181158	893905105E	150381	2223608	160401
078906265AA	181592	321191261C	160422	8A0905105	150381	2223639	160400
078906433B	150453	321906059D	160374	8A0906091	070071	285211	070054
078919501B	181402	321906059E	160374	8A1820021	160621	285227	160352
078919501C	181400	321906059F	160374	8D0405351	150406	285230	150074
079 906 265	181591	321906059G	160375	8D0959263	160763	30617335	181592
07K905715	150510	321906059H	160372	8D2820021	160620	30617336	181592
07K905715A	150510	321911261	160420	94460613300	181584	30622252	181591
085941521	181148	321911261C	160422	J8353014030	180641	30637520	181591
105094200	180626	321955531A	160749	J853014030	180641	30637521	181591
110914010	150395	333955651	160381	N10424901	192798	30637837	181591
113919081	180634	357820021	160513	N10424902	192799	30650109	181591
113945515H	180791	357905104	150228	N10424903	192800	30713416	150514
115915080	150215	357906381A	160637	N10424905	192803	30872555	160461
115939031	181158	357911253	160460	N10424906	192804	30873658	160461
115939070	180726	357911253A	160459	SE0219470001	180839	3205207	160197
12141244089	150056	357919501A	180883	SE021947000C	180805	32112047	181073
12141244191	150056	357919521D	180987	SE021947000I	180839	32772047	181073
171911161E	160420	357955531	160749	SE022942000A	180630	3285227	160352
171911261	160420	357959263	160764	SE028915000B	150419	32866410	181077
171911261D	160421	35906265D	181587	SE127952000A	180726	32876773	150185
171911261E	160421	377906309C	180559	SE127952600A	181001	32923195	180732
171919521F	180949	379905352	150171	SE141947000A	180945	32940645	150395
171955651	160197	3B0951221	160712	X039416000	150056	3411400	180557
175919501	180839	3B0951223	160712	X03952640	180875	3450030	180317
191205351B	150075	3B0955531	160749	X03952671	160353	34741140	181191
191819021	160768	411941583B	160654	X039678360	150056	34741143	181191
191905351	150075	411941583C	160654			3477646	160197
191905351A	150075	431955651	160197	VOLVO		3501922	150074
191905351B	150075	437955651	160197	1219142	181584	3507934	150226
191905351C	150075	443906059	160374	1257137	180635	3517501	180839
191911261A	160421	443906059A	160374	12571378	180635	35175017	180839
191911261C	160421	443907385	160374	12571769	180807	3523608	160401
191945515	180757	443907385B	160375	1257216	180839	3523639	160400
191945515A	180757	443907385C	160372	12576179	180807	35254	150395
191945515B	180757	443907385E	160373	1258016	160197	3531075	181589
191951113B	160658	443907385F	160373	1259832	160197	3531251	181587
191951113D	160658	443907385G	160372	1266085	180660	3531400	181587
191951221	160712	443907385H	160372	12660855	180660	35446913	180734
191951223	160712	443907385J	160373	12660858	180660	35453166	180665
191955531	160749	443907385K	160373	1270535	181588	35456961	180665
191959101	160768	443911261	160420	1271576	181586	35601160	160416
191959263	160760	443955531	160749	1271939	181588	36446913	180734
191959481C	181126	477 906 205	181584	1271940	181588	3650116	160416
1H0919481B	181133	477906205	181584	1271955	181588	464901	181584
1H0951113A	160658	481945515	180734	1271986	181588	464947	181584
1H0951113C	160658	4A0905105B	150381	1274144	181584	679364	180734
1H0959481	181133	4A0905351	150409	1274367	181584	6793640	180734
1H0959481C	181133	4A0905351A	150409	1274746	181584	6820812	160734
1H1819021	160591	4A0955651	160681	1275174	150226	6842522	181588
1H6955651	160378	4A0955651B	160682	1275610	181588	6842619	181588
1H0919418B	181133	4A0959101A	160710	1276951	181584	7035254	150395
1H0959481	181133	4D0905351	150406	1287028	160792	708630207	150429
1H0959481C	181133	4O0905351	150406	1298429	150055	708630215	150430
1J0906381A	160637	620805104	150227	1306932	070054	834461	150395

ACCESSORIES

OE No.	HC-CARGO	OE No.	HC-CARGO	OE No.	HC-CARGO	OE No.	HC-CARGO
VOLVO continued							
8627600	181591	20200140	160155				
8642230	181591	20201000	160308				
8658090	181591	20201000A	160308				
8670112	181495	20201100	160081				
8670130	181591	20201100A	160081				
8670167	181591	20201101	160403				
8670263	181495	20201103	160270				
8677894	181591	20206100	160267				
874368	192902	20207100	160265				
9125371	181588	20207100A	160265				
9125372	181588	20210100	160083				
9125580	181588	20211100	160316				
9125582	181588	20213000	161011				
9125601	150514	20400000	160307				
9135621	181585	20400100	160082				
9135622	181588	20400100A	160082				
9135664	181589	20400102	160473				
9135793	181587	20400111	160240				
9135794	181585	20401000	160337				
9142045	070054	20401100	160216				
9146108	150496	20401100A	160216				
9148494	181584	20401103	160271				
9162987	160458	20406100	160268				
9179101	181588	20407100	160266				
9186934	181592	20410100	160215				
9202719	181588	20411100	160317				
9434225	160792	21203100	160168				
9458187	181591	21403100	160169				
9458189	181592	22200111	160239				
9470011	181591	22200117A	160239				
9497345	181592	22400111	160240				
9497347	181592	22400117A	160240				
968372	171026	29200006	160363				
968689	171025	29200045	160364				
981189	171377	29201005	160365				
990053	192902	29201045	160366				
		29201075	160367				
		29401000	160368				
WAI		29401041	160521				
42-3301	132581	50205002	160295				
66-2757	191351	50205603	160295				
		50237009	160459				
WALBRO		50237010	160460				
6103W	070143	51204003	160348				
		51216001	160416				
WEBCON		51216002	160416				
11014T12	180356	51216003	160416				
11123	180359	51216901	160421				
11984	180337	51223908	160352				
11999	180371	51223909	160352				
13704	210762	51233001	160421				
13710	210763	51233006	160421				
5810001602	180559	51233011	160422				
5810600900	180317	51299002	160424				
9890150300	180421	51299003	160431				
9890175100	180485	51299004	160432				
GAS1	180526	51299006	160431				
WMS001	180557	51299007	160453				
WMS005	180558	51401004	160466				
WMS015	180559	54201006	160305				
		54201030	160305				
		54201101	160242				
WEHRLE		54201102	160243				
10485007	190767	54201103	160244				
10485008	190766	54201108	160314				
10700005	191026	54212001	160314				
13003404	160769	54229001	160263				
13132030	160441	54229002	160263				
13132031	160442	54401101	160261				
13132032	160443	54401102	160296				
13132033	160444	54407006	160262				
13132034	160445	54407008	160199				
13132035	160446	58226606A	160904				
13132036	160447	58226608	160904				
13132037	160448	60201001	160297				
13731048	160425	60201002	160297				
13735045	160438	60215005	160287				
13735052	160425	73505412	160429				
20200000	160282						
20200006	160282						
20200100A	160080	WOOD-UK					
20200102	160155	SDV38574	134914				
20200111	160239						



Index

Edition 2014/2015



HC-CARGO	Page	HC-CARGO	Page	HC-CARGO	Page	HC-CARGO	Page
040018	294	070148	225	080178	219	080294	251
040019	294	070149	225	080188	258	080295	237
040077	292	070150	226	080205	251	080296	583
040094	292	070151	226	080207	220	080297	530
040096	294	070152	226	080208	220	080298	547
040149	296	070153	224	080209	220	080338	254
040170	296	070154	222	080210	220	080340	254
040177	293	070155	223	080211	220	080345	254
040178	293	070156	223	080212	220	080352	239
040181	293	070157	223	080231	584	080385	584
040182	293	070160	223	080232	587	080386	584
040190	293	070161	229	080236	584	080387	583
040191	293	070162	233	080237	546	080388	584
040192	294	070172	224	080238	546	080389	254
040193	296	070173	226	080239	546	080390	584
040194	296	070175	233	080240	546	080392	584
040197	295	070177	228	080241	546	080394	584
040199	294	070181	231	080242	546	080395	584
040200	294	070182	227	080243	546	080397	582
040201	295	070183	229	080245	546	080398	584
040215	294	070184	230	080246	546	080400	583
060058	278	070187	229	080247	546	080401	583
060059	277	070188	229	080251	547	080402	583
060210	275	070191	229	080252	547	080403	582
060211	275	070192	224	080253	547	080404	583
060213	277	070203	224	080254	547	080405	584
060214	277	070206	224	080255	547	080406	584
060216	276	070207	225	080256	547	080407	584
060219	278	070208	226	080257	547	080408	583
060220	276	070209	227	080258	547	080409	584
060222	276	080001	547	080259	529	080410	582
060223	276	080002	546	080260	529	080411	583
060227	278	080003	546	080261	529	080412	582
060229	277	080004	585	080262	529	080413	584
060233	276	080031	583	080263	529	080414	584
060235	277	080032	583	080264	529	080415	584
060237	278	080033	583	080265	529	080416	584
060241	277	080034	583	080266	529	080417	582
06219	524	080035	583	080267	529	080418	584
070003	227	080036	583	080268	530	080419	584
070004	227	080038	239	080269	547	080423	584
070019	230	080039	583	080270	547	080424	584
070021	230	080046	253	080271	547	080425	582
070032	228	080047	253	080272	547	080426	582
070053	233	080055	253	080273	547	080427	582
070054	233	080059	250	080274	546	080428	583
070055	233	080060	250	080275	546	080430	583
070056	230	080064	250	080276	546	080431	583
070057	230	080070	236	080277	549	080432	583
070058	227	080071	236	080278	549	080433	583
070067	230	080097	251	080279	549	080434	583
070070	231	080099	236	080280	549	080435	583
070076	228	080114	239	080281	549	080436	583
070077	231	080161	587	080282	549	080437	584
070078	228	080162	587	080283	547	080438	583
070107	228	080163	587	080284	547	080439	582
070134	228	080164	587	080285	529	080440	583
070143	229	080165	587	080286	529	080441	583
070144	223	080168	236	080287	530	080442	583
070145	224	080170	237	080288	530	080443	583
070146	225	080174	258	080289	530	080444	583
070147	225	080177	219	080292	237	080446	583

HC-CARGO	Page	HC-CARGO	Page	HC-CARGO	Page	HC-CARGO	Page
080447	583	080731	547	080877	255	090001	249
080448	583	080732	584	080878	255	090015	233
080449	584	080733	584	080879	255	090016	234
080450	583	080734	583	080926	221	090020	234
080451	583	080736	584	080929	221	090027	247
080452	583	080738	251	080930	530	090042	247
080453	583	080739	582	080931	530	090047	240
080454	583	080742	237	080933	251	090055	248
080456	582	080744	546	080940	219	090057	248
080457	254	080745	546	080941	219	090061	246
080458	254	080751	545	080942	219	090062	248
080459	254	080752	240	080944	243	090071	244
080465	244	080757	240	080953	252	090072	245
080467	255	080761	583	080954	232	090073	245
080575	547	080763	583	080955	232	090074	252
080582	255	080764	584	080958	232	090076	239
080583	255	080766	251	080959	232	090078	529
080595	220	080773	247	080960	232	090079	529
080614	246	080777	583	080961	583	090080	529
080621	529	080778	255	080963	252	090081	529
080625	547	080782	583	080964	252	090082	529
080626	547	080783	238	080969	240	090086	253
080627	547	080793	238	080972	252	090087	253
080628	545	080794	546	080989	583	090090	248
080629	545	080795	546	080994	221	090092	258
080630	545	080799	546	080995	221	090095	211
080631	545	080802	583	080996	221	090096	211
080653	545	080803	583	080998	222	090097	212
080654	545	080805	244	081000	222	090098	212
080655	545	080809	252	081001	222	090099	211
080656	545	080811	238	081002	222	090100	211
080657	545	080812	547	081003	238	090101	213
080659	546	080813	251	081004	247	090102	213
080660	546	080815	247	081006	545	090103	211
080661	546	080816	247	081007	244	090104	211
080662	546	080824	247	081039	232	090105	212
080663	546	080826	546	081040	232	090106	212
080664	546	080828	258	081041	256	090107	212
080665	546	080829	530	081055	582	090108	212
080666	546	080830	530	081058	238	090109	213
080667	530	080831	530	081067	582	090110	213
080668	530	080834	530	081068	582	090111	213
080669	530	080836	547	081088	583	090113	214
080677	584	080838	547	081097	241	090115	218
080678	546	080839	547	081113	582	090116	218
080679	546	080840	238	081114	582	090117	557
080680	221	080843	546	081115	582	090127	245
080688	583	080851	529	081116	547	090133	560
080689	582	080852	238	081117	219	090136	248
080691	582	080854	231	081120	219	090144	239
080692	583	080855	231	081129	256	090145	243
080693	583	080857	231	081146	583	090146	244
080695	237	080858	231	081148	584	090147	253
080696	582	080859	546	081166	222	090150	248
080697	582	080860	546	081169	560	090151	234
080701	244	080863	546	081172	582	090153	560
080702	244	080864	546	081173	582	090156	234
080703	237	080865	257	081176	243	090159	239
080705	583	080866	257	081183	583	090160	216
080721	252	080868	258	081209	582	090161	216
080724	560	080873	221	081212	582	090165	258
080730	237	080875	231	081220	547	090166	245

ACCESSORIES

O. E. M. names and numbers are used for reference purposes only.

HC-CARGO	Page	HC-CARGO	Page	HC-CARGO	Page	HC-CARGO	Page
090167	245	090305	562	100280	259	100537	260
090168	217	090310	574	100282	259	100538	260
090169	217	090314	235	100283	259	100540	260
090170	528	090315	236	100284	259	100541	260
090171	528	090316	245	100286	259	100544	260
090172	245	090317	218	100287	259	100545	260
090183	250	090318	218	100288	259	100547	260
090187	234	090319	246	100291	259	100548	260
090192	250	090320	246	100292	259	100555	260
090193	241	090325	560	100295	259	100556	260
090194	241	090327	562	100302	259	100557	260
090197	234	090333	250	100303	259	100559	260
090198	234	090334	218	100306	259	100560	260
090199	214	090335	562	100307	259	100561	260
090200	214	090337	236	100310	259	100562	260
090202	235	090344	249	100320	259	100563	260
090203	241	090345	242	100323	259	100565	260
090206	214	090346	242	100324	259	100566	260
090210	217	090347	246	100325	259	100573	257
090212	258	090348	215	100326	259	100578	260
090213	242	090349	562	100327	259	100580	260
090216	214	090355	562	100331	259	100581	260
090218	213	090357	564	100335	259	100583	260
090222	248	090362	250	100336	259	100587	260
090223	249	090368	215	100337	259	100590	260
090224	217	090370	216	100339	259	100592	260
090225	214	090371	216	100342	256	100593	260
090226	215	090372	563	100344	256	100594	260
090228	215	090373	216	100348	256	100595	260
090233	249	090380	527	100352	256	100597	240
090235	235	090381	246	100353	256	100598	241
090239	561	090391	236	100358	257	100614	260
090241	561	090402	218	100426	259	100616	260
090242	249	090404	242	100429	259	100619	260
090244	241	090407	563	100432	259	100622	260
090246	249	090409	563	100433	259	100624	260
090250	235	090421	239	100434	259	100625	260
090251	235	090430	218	100435	259	100627	260
090253	235	090431	216	100436	259	100634	260
090254	235	090434	563	100471	257	100636	260
090255	560	090438	564	100490	257	100637	260
090257	560	100079	259	100510	259	100639	260
090259	563	100086	259	100511	259	100640	260
090267	215	100177	259	100512	259	100641	260
090268	217	100245	259	100513	259	100642	260
090269	561	100246	259	100514	260	100644	260
090270	574	100247	259	100515	260	100645	260
090272	574	100251	259	100516	260	100646	260
090273	561	100252	259	100518	260	100650	260
090277	240	100254	259	100520	260	100651	260
090278	240	100256	259	100521	260	100652	260
090281	215	100257	259	100522	260	100653	260
090282	561	100258	259	100523	260	132804	378
090285	561	100259	259	100524	260	134686	535
090287	561	100260	259	100525	257	134699	583
090288	562	100261	259	100527	260	134768	583
090292	560	100262	259	100529	260	135061	548
090293	528	100263	259	100531	260	150004	311
090294	249	100271	259	100532	260	150037	304
090296	563	100275	259	100533	260	150055	304
090297	217	100276	259	100534	260	150056	305
090301	562	100277	259	100536	260	150057	305

HC-CARGO	Page	HC-CARGO	Page	HC-CARGO	Page	HC-CARGO	Page
150058	305	150403	310	160083		160311	448
150062	305	150404	328	160115	469	160312	470
150063	305	150406	309	160116	469	160313	473
150064	305	150407	295	160150	282	160314	470
150067	305	150408	295	160155	448	160315	470
150068	306	150409	310	160167	192	160316	459
150072	306	150414	328	160168	456	160317	461
150075	306	150415	301	160169	456	160318	471
150088	306	150416	301	160186	286	160321	279
150091	306	150417	310	160187	286	160322	279
150092	306	150424	301	160188	286	160323	279
150096	306	150428	301	160190	291	160325	279
150098	307	150429	301	160192	291	160326	279
150100	295	150430	301	160195	292	160327	279
150101	295	150433	302	160197	287	160328	279
150154	307	150434	302	160198	287	160329	279
150157	307	150435	311	160199	473	160330	279
150160	307	150441	302	160213	189	160332	287
150165	307	150445	328	160215	452	160333	189
150168	307	150451	328	160216	461	160334	189
150169	304	150468	328	160223	287	160337	461
150171	307	150470	328	160239	450	160338	281
150175	308	150496	328	160240	454	160339	281
150183	299	150505	302	160242	469	160341	471
150187	299	150506	302	160243	469	160342	197
150196	299	150508	302	160244	470	160343	197
150215	308	150509	302	160250	268	160345	284
150227	310	150512	310	160251	268	160346	184
150228	310	150513	303	160252	268	160347	447
150231	310	150514	303	160253	268	160348	464
150234	308	150516	311	160256	280	160350	464
150235	308	150518	303	160257	280	160352	465
150236	308	150519	303	160258	283	160353	465
150239	308	150520	303	160261	473	160354	465
150246	299	150521	303	160262	473	160355	188
150247	299	150522	303	160263	470	160356	188
150252	299	150523	304	160265	448	160357	284
150259	300	150524	304	160266	452	160358	281
150266	300	150525	304	160267	457	160359	281
150267	300	160002	187	160270	459	160360	288
150270	300	160005	267	160271	461	160361	288
150272	300	160006	268	160272	454	160363	455
150273	300	160019	279	160273	286	160364	456
150275	300	160022	280	160274AT	447	160365	458
150278	301	160023	280	160276	447	160366	458
150332	326	160024	280	160278	447	160367	458
150336	327	160025	279	160282	448	160368	460
150340	327	160026	279	160287	464	160370	279
150343	327	160028	279	160289	287	160372	465
150354	327	160031	283	160290	284	160373	465
150360	327	160032	283	160291	284	160374	465
150361	327	160033	283	160292	284	160375	466
150366	327	160034	283	160293	284	160376	282
150377	308	160035	279	160294	397	160378	288
150378	309	160036	185	160295	464	160379	288
150379	309	160038	187	160296	473	160380	288
150380	309	160039	188	160297	462	160381	288
150384	309	160042	189	160300	397	160382	288
150387	309	160048	187	160305	470	160383	289
150395	304	160080	448	160306	190	160385	289
150398	309	160081	459	160307	453	160386	289
150401	527	160082	452	160308	459	160387	190

ACCESSORIES

O. E. M. names and numbers are used for reference purposes only.

HC-CARGO	Page	HC-CARGO	Page	HC-CARGO	Page	HC-CARGO	Page
160388	190	160470	466	160586	279	160680	290
160389	190	160473	453	160587	272	160681	290
160390	191	160474	471	160588	272	160682	291
160391	191	160475	471	160590	263	160683	291
160392	192	160477	451	160591	263	160684	291
160393	186	160477Z	451	160592	265	160685	291
160394	461	160478	454	160593	265	160686	291
160395	282	160480	449	160594	265	160688	292
160396	282	160481	185	160595	272	160689	185
160398	198	160482	185	160596	265	160695	297
160399	198	160483	264	160597	272	160696	297
160400	466	160484	281	160598	270	160697	296
160401	466	160485	281	160599	273	160698	296
160402	471	160486	281	160600	273	160699	298
160403	459	160487	282	160601	270	160700	298
160407	475	160502	192	160603	182	160701	297
160408	285	160503	285	160610	181	160702	297
160409	397	160504	285	160611	182	160710	263
160410	184	160506	285	160612	183	160712	186
160411	279	160507	289	160613	183	160714	273
160413	292	160508	188	160619	273	160716	474
160414	186	160509	448	160620	263	160718	261
160415	186	160510	264	160621	263	160719	261
160416	261	160511	264	160622	269	160720	451
160417	261	160512	264	160626	269	160721	454
160418	261	160513	262	160627	195	160725	286
160419	261	160515	262	160628	279	160727	280
160420	261	160518	262	160629	290	160734	268
160421	261	160520	262	160630	290	160735	198
160422	261	160521	460	160631	263	160737	273
160423	261	160528	262	160632	188	160739	270
160424	261	160533	185	160633	279	160740	198
160425	261	160534	185	160635	279	160741	279
160426	261	160535	289	160637	464	160742	198
160431	261	160536	269	160638	279	160744	188
160432	261	160537	269	160639	266	160745	279
160433	261	160538	269	160640	192	160746	186
160434	261	160539	269	160641	279	160747	297
160435	261	160541	193	160642	191	160748	279
160436	261	160542	194	160643	279	160749	463
160438	261	160543	193	160644	191	160750	279
160439	261	160544	194	160645	279	160751	466
160441	261	160545	193	160646	191	160753	279
160442	261	160546	194	160647	266	160755	279
160443	261	160548	266	160648	279	160756	188
160444	261	160549	266	160649	266	160758	280
160445	261	160550	262	160650	279	160760	267
160446	261	160551	397	160651	469	160761	279
160447	261	160556	265	160652	448	160762	267
160448	261	160557	265	160653	279	160763	267
160449	261	160558	285	160654	462	160764	267
160451	261	160561	262	160655	279	160765	267
160452	261	160565	266	160658	186	160766	279
160453	261	160569	193	160659	285	160767	263
160458	261	160570	462	160660	193	160768	264
160459	261	160571	282	160661	279	160769	454
160460	261	160578	468	160671	282	160771	279
160461	261	160579	192	160672	183	160775	180
160464	261	160580	192	160674	268	160776	182
160466	463	160581	194	160676	194	160777	273
160468	450	160583	289	160677	290	160778	298
160469	261	160584	272	160679	290	160779	298

HC-CARGO	Page	HC-CARGO	Page	HC-CARGO	Page	HC-CARGO	Page
160783	180	160933	456	160999	275	170213	131
160784	182	160934	457	161000	271	170237	37
160786	324	160935	453	161001	275	170239	54
160787	326	160936	453	161002	271	170292	34
160791	471	160937	455	161003	272	170293	50
160792	466	160938	457	161004	275	170295	10
160793	180	160939	457	161005	180	170296	10
160794	267	160940	452	161006	182	170308	15
160795	261	160941	452	161007	182	170309	15
160796	181	160942	460	161008	464	170310	52
160797	193	160944	461	161009	450	170311	52
160799	274	160945	450	161010	460	170313	37
160872	298	160946	452	161011	457	170331	164
160873	298	160947	454	161012	457	170332	156
160874	196	160948	472	161013	279	170333	156
160875	196	160949	472	161014	196	170334	157
160876	198	160950	472	161015	197	170335	169
160877	199	160951	472	161016	197	170336	162
160878	266	160952	474	161017	197	170337	162
160879	264	160953	474	161018	197	170338	167
160880	181	160954	472	161019	197	170339	163
160881	283	160955	474	161399	278	170340	163
160884	184	160956	472	161400	278	170341	162
160885	270	160957	473	161425	278	170342	162
160887	181	160958	474	161450	278	170343	162
160888	183	160959	474	161480	278	170344	162
160889	183	160960	191	161500	278	170345	163
160890	453	160961	183	161530	278	170346	163
160897	297	160965	184	161550	278	170347	164
160899	189	160966	275	161580	279	170348	157
160900	190	160967	287	161600	278	170349	169
160901	190	160968	196	161650	278	170350	167
160902	456	160969	196	161700	278	170351	169
160903	449	160970	91, 106, 195	170002	116	170353	143
160904	447	160971	91, 106, 195	170005	162	170357	166
160906	274	160972	181	170006	157	170358	166
160907	274	160973	286	170009	157	170359	157
160908	274	160974	460	170032	128	170360	157
160909	274	160975	455	170033	128	170362	156
160910	270	160976	462	170035	128	170364	165
160911	270	160977	455	170036	129	170366	15
160912	271	160978	455	170069	156	170380	168
160913	271	160979	455	170070	156	170387	34
160914	271	160980	462	170071	157	170390	142
160915	271	160981	462	170093	37	170391	142
160916	183	160982	450	170130	37	170392	142
160917	292	160983	450	170132	52	170393	142
160918	456	160984	458	170135	146	170394	138
160919	458	160985	458	170136	146	170395	138
160920	459	160986	187	170137	146	170396	138
160921	449	160987	187	170138	147	170397	136
160922	451	160988	187	170139	147	170398	136
160923	451	160989	187	170142	130	170399	136
160924	468	160990	196	170143	130	170401	138
160925	468	160991	194	170144	130	170402	138
160926	453	160992	463	170163	130	170403	136
160927	463	160993	184	170165	130	170404	137
160928	463	160994	180	170169	130	170405	35
160929	449	160995	182	170170	130	170406	35
160930	184	160996	180	170171	141	170407	142
160931	451	160997	182	170208	131	170410	164
160932	460	160998	274	170212	131	170411	162

ACCESSORIES

O. E. M. names and numbers are used for reference purposes only.

HC-CARGO	Page	HC-CARGO	Page	HC-CARGO	Page	HC-CARGO	Page
170412	156	170564	50	170659	162	170769	169
170413	163	170573	166	170660	163	170770	161
170414	162	170574	166	170662	164	170771	166
170415	162	170575	167	170663	169	170772	169
170416	163	170576	156	170664	129	170773	163
170417	163	170577	166	170665	101	170774	163
170419	35	170578	166	170668	110	170775	164
170433	147	170579	167	170670	67	170776	162
170435	10	170580	163	170671	67, 111	170777	170
170436	10	170583	169	170673	169	170778	164
170437	10	170584	169	170674	167	170779	164
170438	10	170585	169	170675	132	170780	164
170448	163	170586	169	170676	132	170781	164
170449	156	170588	162	170677	133	170782	166
170450	157	170589	162	170680	20	170783	166
170451	169	170590	162	170681	157	170784	166
170452	162	170591	162	170683	143	170785	166
170453	162	170592	162	170684	164	170788	36
170454	169	170593	163	170685	77	170789	36
170455	163	170594	163	170687	83	170790	147
170456	163	170596	147	170688	75	170791	148
170460	35	170598	11	170689	73	170792	157
170470	168	170599	12	170690	54	170793	169
170474	163	170601	12	170692	159	170794	163
170475	162	170602	91	170693	159	170795	163
170476	164	170603	91	170694	159	170796	163
170477	164	170604	85	170696	156	170797	143
170480	169	170610	166	170698	165	170798	12
170481	169	170611	166	170710	160	170799	148
170482	163	170612	166	170711	160	170800	158
170489	38	170613	166	170712	168	170802	157
170490	11	170614	169	170713	65	170803	157
170491	11	170616	56	170718	157	170804	157
170492	15	170617	164	170720	158	170805	164
170493	156	170619	147	170723	156	170806	164
170494	156	170620	58	170724	162	170807	164
170496	157	170621	58	170725	164	170808	164
170502	168	170623	131	170726	161	170809	120
170503	163	170624	131	170727	166	170810	164
170505	15	170625	131	170729	133	170811	158
170506	15	170626	131	170730	133	170812	158
170507	169	170627	132	170731	167	170813	170
170509	167	170628	132	170732	167	170814	166
170512	156	170629	132	170741	158	170815	166
170513	157	170630	132	170742	159	170816	167
170514	157	170631	132	170746	119	170822	163
170515	157	170632	110	170748	119	170824	156
170525	16, 22	170633	110	170749	168	170825	158
170528	16, 22	170635	111	170750	168	170826	169
170531	35	170636	111	170751	168	170827	148
170534	38	170640	110	170752	168	170828	120
170537	35	170641	111	170753	166	170829	120
170540	11	170642	111	170754	164	170830	12
170541	11	170643	572	170755	166	170833	83, 121
170542	164	170644	162	170756	166	170834	65, 121
170543	16	170648	169	170757	166	170835	120
170545	166	170650	20	170758	166	170836	156
170549	56	170651	20	170759	142	170837	158
170550	56	170653	23, 51	170761	169	170839	168
170551	11	170654	22	170762	165	170843	52
170552	109	170657	157	170763	147	170844	54
170562	35	170658	169	170768	157	170846	77

HC-CARGO	Page	HC-CARGO	Page	HC-CARGO	Page	HC-CARGO	Page
170847	83	170986	78	171070	156	171141	66
170848	168	170987	83	171071	156	171147	66
170849	169	170989	65	171072	156	171148	66
170850	162	170990	93	171073	156	171153	66
170851	38	170991	93	171076	169	171162	84
170857	38	170998	93	171077	158	171164	116
170859	38	170999	93	171078	169	171166	116
170865	53	171000	101	171079	158	171167	40
170867	55	171005	20	171080	158	171168	40
170868	55	171006	53	171081	158	171171	60
170875	59	171007	54	171082	158	171173	106
170880	67	171008	54	171083	159	171174	60
170881	59	171009	160	171084	159	171175	68
170884	68	171010	161	171086	169	171178	106
170885	68	171013	78	171088	169	171179	60
170887	60	171014	78	171089	169	171180	68
170893	91	171015	83	171090	169	171181	106
170895	92	171016	83	171091	169	171182	60
170909	74, 76, 104	171017	12	171092	161	171183	66
170910	75, 76, 101	171019	12	171093	161	171188	93
170916	92	171023	164	171094	162	171189	94
170917	92	171024	164	171095	162	171190	94
170922	92	171025	165	171096	162	171191	80
170923	92	171026	165	171097	162	171192	80, 94
170925	64	171027	164	171098	162	171193	80, 94
170927	64	171028	164	171099	162	171194	80, 94
170928	75	171029	165	171100	162	171195	80, 94
170929	75	171030	164	171102	163	171196	110
170930	75	171031	165	171103	163	171197	107
170932	73	171032	165	171104	164	171202	80
170934	73	171033	166	171105	164	171203	81
170935	73	171034	160	171106	164	171204	81
170936	116	171035	160	171107	164	171205	95
170938	169	171036	160	171108	164	171206	95
170939	77, 122	171037	160	171109	164	171209	95
170940	77, 122	171038	53	171110	164	171210	95
170941	64, 122	171039	159	171111	165	171213	81
170942	122	171040	170	171112	165	171214	81
170943	77	171042	170	171113	157	171215	64
170944	83	171043	170	171114	157	171217	64
170945	16	171044	170	171117	158	171218	64
170946	69	171045	116	171118	163	171219	75
170948	164	171048	133	171119	163	171220	76
170951	161	171049	120	171120	162	171222	74
170952	61	171050	78	171121	164	171224	116
170959	145	171051	79	171122	164	171225	117
170960	145	171052	79	171123	164	171228	133
170964	148	171053	79	171124	168	171230	133
170965	156	171054	79	171125	157	171233	133
170968	101	171055	79	171127	167	171236	84
170970	39	171056	84	171128	168	171237	84, 101
170972	165	171057	84	171129	168	171242	61
170974	53	171058	84	171130	168	171252	102
170975	69	171059	84	171131	168	171253	85
170976	61	171060	13	171132	161	171258	85
170979	39	171061	13	171133	161	171259	85
170980	39	171062	101	171134	157	171263	102
170981	39	171064	157	171135	159	171264	85
170982	39	171065	157	171136	156	171265	85
170983	40	171066	157	171137	158	171266	86
170984	40	171067	157	171139	162	171280	167
170985	78	171068	156	171140	66	171281	149

ACCESSORIES

O. E. M. names and numbers are used for reference purposes only.

HC-CARGO	Page	HC-CARGO	Page	HC-CARGO	Page	HC-CARGO	Page
171282	149	171403	169	171513	36	171610	62
171283	164	171404	156	171518	400, 36	171611	49
171284	165	171405	156	171521	103	171612	50
171299	95	171407	167, 156	171528	111	171613	161
171302	96	171408	167	171529	112	171614	21
171303	96	171410	167	171530	112	171615	49
171306	96	171411	167	171531	166	171617	112
171307	102	171417	69	171532	158	171618	70
171308	96	171419	69	171533	82	171619	41
171311	96	171423	13	171534	82	171620	41
171312	102	171424	13	171536	134	171621	119
171322	102	171425	168	171537	86	171622	117
171328	81, 97	171426	148	171538	86	171624	117
171329	82, 97	171427	148	171540	21	171625	50
171330	85, 102	171428	123	171541	21	171626	50
171331	107	171441	97	171549	87, 104	171627	110
171332	60	171442	97	171550	106	171635	108
171337	67	171443	97	171554	137	171636	70
171339	67	171444	98	171555	137	171637	108
171343	68	171446	102	171556	137	171638	62
171345	117	171447	98	171561	21	171639	72
171347	40	171448	98	171562	400, 36	171640	42
171349	16	171449	41	171564	41	171642	23
171351	13	171451	58	171565	53	171644	23
171354	16	171452	58	171566	41	171646	23
171355	16	171453	148	171567	139	171648	23
171356	123	171454	166	171568	139	171650	23
171359	56	171455	165	171569	137	171651	24
171360	56	171464	51	171570	137	171652	24
171361	57	171466	51	171571	139	171654	24
171362	57	171469	156	171572	138	171657	26
171363	57	171470	169	171573	145	171658	27
171364	57	171471	169	171574	139	171659	27
171365	57	171472	163	171575	138	171660	27
171366	57	171473	157	171576	36	171661	24
171369	68	171474	157	171577	14	171662	24
171371	169	171475	169	171579	107	171663	27
171372	86	171476	162	171580	107	171664	27
171373	86	171477	167	171581	69	171665	87, 104
171375	51	171479	162	171582	69	171666	87, 104
171376	22	171480	163	171583	61	171667	87
171377	165	171481	163	171584	61	171668	87
171378	167, 156	171483	163	171587	14	171671	43
171379	164	171484	162	171588	14	171672	43
171380	164	171485	162	171590	22	171673	17
171381	164	171486	162	171591	112	171674	17
171382	165	171487	162	171592	112	171675	27
171383	164	171488	162	171593	112	171676	124
171384	165	171489	162	171594	49	171677	124
171386	164	171490	163	171595	50	171679	124
171388	165	171491	163	171597	58	171680	29
171389	165	171492	163	171598	58	171681	28
171390	169	171493	61	171599	107	171682	32
171391	164	171494	14	171600	107	171683	161
171392	129	171495	20	171601	70	171684	74
171393	129	171497	20	171602	70	171685	76
171396	129	171498	21	171603	62	171686	156
171397	129	171505	21	171604	62	171687	157
171398	170	171506	98	171605	108	171688	158
171399	13	171507	103	171607	70	171689	158
171401	163	171508	98	171608	70	171690	160
171402	169	171510	65	171609	62	171691	158

HC-CARGO	Page	HC-CARGO	Page	HC-CARGO	Page	HC-CARGO	Page
171695	124	171763	17	171831	126	171893	141
171696	124	171764	17	171832	127	171894	141
171700	99	171765	25	171833	123	171895	141
171701	99	171766	28	171834	123	171896	141
171702	103	171767	125	171835	72	171897	141
171703	103	171768	125	171836	73	171898	135
171704	144	171769	125	171837	165	171899	135
171705	14	171770	67	171838	45	171900	135
171706	111	171771	109	171839	72	171901	135
171708	22	171772	89	171840	109	171902	136
171709	117	171773	125	171841	63	171903	136
171710	161	171774	44	171842	72	171904	25
171711	161	171775	44	171843	109	171905	25
171712	161	171776	125	171844	63	171906	26
171713	161	171777	32	171845	42	171907	28
171714	118	171778	32	171846	45	171908	28
171715	118	171779	32	171847	45	171909	31
171716	118	171780	33	171848	42	171910	31
171717	62	171781	33	171849	29	171911	31
171718	63	171782	42	171850	30	171912	31
171719	108	171783	149	171851	30	171913	31
171720	108	171784	149	171852	30	171914	32
171721	71	171787	143	171853	30	171915	34
171722	71	171788	86, 103	171854	30	171916	34
171723	43	171789	89	171855	33	171917	82, 101
171725	88, 104	171790	89	171856	33	171918	17
171726	74, 76, 88, 104	171791	89	171857	33	171919	18
171727	43	171793	14	171858	33	171920	18
171728	27	171794	159	171859	34	171921	18
171729	71	171795	122	171860	72	171922	18
171730	113	171796	160	171861	109	171923	18
171731	113	171797	143	171862	63	171924	149
171732	113	171798	22	171863	127	171925	149
171733	113	171800	65	171864	127	171926	26
171734	113	171801	65	171865	34	171927	90, 105
171735	71	171802	99	171866	127	171928	90, 105
171736	71	171803	99	171867	109	171929	90, 105
171737	118	171804	159	171868	63	171930	90, 105
171738	118	171805	144	171869	169	171931	18
171739	59	171806	99	171870	100, 123	171932	45
171740	59	171807	100	171871	100, 123	171933	26
171741	59	171808	100	171872	121	171934	26
171742	71	171809	100	171873	121	171935	121
171743	108	171810	103	171874	127	171936	51
171744	63	171811	45	171875	127	171937	54
171745	42	171813	25	171876	128	171938	46
171746	24	171814	25	171877	128	171939	46
171747	168	171815	25	171878	139	171940	46
171748	168	171816	28	171879	139	171941	19
171749	143	171817	28	171880	140	171942	19
171750	124	171818	120	171881	140	171943	26
171751	43	171820	29	171882	140	171944	46
171752	44	171821	121	171883	134	171945	46
171753	44	171822	82, 122	171884	134	171946	47
171755	44	171823	117	171885	134	171947	47
171756	88	171824	118	171886	134	171948	47
171757	88	171825	125	171887	134	171949	47
171758	88	171826	126	171888	135	171950	47
171759	89	171827	126	171889	135	171951	47
171760	29	171828	126	171890	140	171952	90, 105
171761	29	171829	126	171891	140	171953	160
171762	32	171830	126	171892	140	171954	149

ACCESSORIES

O.E.M. names and numbers are used for reference purposes only.

HC-CARGO	Page	HC-CARGO	Page	HC-CARGO	Page	HC-CARGO	Page
171955	48	180092	492	180229	200	180338	203
171956	72	180094	492	180230	400	180339	210
171957	19	180099	481	180232	205	180340	210
171958	113	180100	482	180233	205	180341	210
171959	114	180101	482	180238	411	180343	441
171960	114	180103	494	180239	405	180344	441
171961	114	180104	494	180240	407	180345	441
171962	114	180107	410	180241	412	180346	441
171963	114	180108	410	180242	411	180347	441
171964	114	180110	404	180243	407	180348	441
171965	115	180111	412	180245	417	180349	419
171966	115	180112	407	180247	416	180350	419
171967	115	180113	399	180248	415	180351	408
171968	115	180115	397	180249	406	180352	409
171969	115	180120	495	180251	417	180353	413
171970	115	180121	495	180252	413	180354	398
171971	19	180123	495	180253	409	180372	415
171972	19	180140	492	180254	498	180373	403
171973	19	180141	492	180255	498	180374	203
171999	146	180143	203	180261	498	180375	203
172000	146	180144	414	180263	498	180376	398, 36
172001	48	180147	410	180265	499	180377	37, 398
172002	119	180150	404	180266	499	180380	393
172003	48	180153	407	180268	499	180381	392
172004	48	180154	412	180269	499	180382	392
172005	49	180156	479	180271	200	180383	392
172006	48	180157	398	180272	202	180384	394
172007	74	180158	479	180273	204	180385	394
172008	49	180159	479	180274	202	180386	396
172009	119	180176	482	180275	202	180387	396
180001	414	180177	482	180276	200	180390	392
180007	478	180178	482	180277	202	180391	394
180008	318	180179	482	180278	202	180392	394
180009	318	180180	482	180280	203	180395	396
180010	493	180194	416	180285	413	180396	396
180014	440	180195	416	180286	409	180399	400
180015	440	180196	416	180287	400	180400	495
180016	440	180197	419	180288	204	180401	414
180017	440	180198	419	180289	200	180402	406
180018	491	180199	420	180290	205	180403	414
180021	493	180201	401	180292		180404	410
180022	493	180202	204	180293	405	180405	415
180023	494	180203	199	180296	408	180529	499
180025	208	180206	483	180297	412	180530	392
180027	208	180207	483	180298	402	180531	392
180028	199	180208	484	180305	402	180532	392
180029	203	180209	485	180306	404	180533	394
180036	492	180210	485	180307	404	180534	394
180038	397	180211	199	180308	410	180535	392
180039	489	180212	411	180313	200	180536	394
180040	494	180213	402	180314	479	180537	394
180041	208	180214	405	180315	398	180538	394
180043	208	180215	495	180316	417	180542	393
180044	209	180216	199	180324	208	180543	393
180045	208	180218	404	180325	419	180548	392
180047	494	180219	407	180326	200	180549	394
180048	494	180220	412	180327	403	180550	396
180049	489	180221	402	180328	403	180551	396
180087	199	180225	415	180329	406	180552	396
180088	492	180226	417	180330	411	180554	394
180090	481	180227	417	180332	403	180556	205
180091	492	180228	417	180333	204	180557	314

HC-CARGO	Page	HC-CARGO	Page	HC-CARGO	Page	HC-CARGO	Page
180559	314	180641	315	181201	321	181501	393
180560	420	180648	315	181205	321	181502	393
180561	420	180649	315	181212	321	181503	393
180562	393	180658	315	181233	494	181504	393
180563	393	180660	315	181235	209	181505	393
180568	408	180688	316	181236	209	181510	406
180569	408	180689	316	181237	209	181516	393
180570	412	180694	316	181238	201	181517	394
180571	408	180702	326	181244	207	181518	209
180572	417	180726	318	181245	207	181519	393
180574	403	180734	318	181246	207	181520	393
180575	396	180753	318	181247	206	181521	393
180577	396	180785	318	181249	496	181540	207
180580	395	180790	319	181251	497	181544	416
180581	395	180791	319	181252	497	181545	379
180582	395	180804	324	181253	497	181546	483
180583	395	180808	324	181256	497	181547	411
180584	489	180820	325	181257	497	181548	398
180585	489	180839	325	181258	497	181549	399
180586	490	180848	325	181263	498	181550	399
180587	490	180861	325	181264	498	181551	493
180588	490	180875	326	181270	204	181552	493
180589	490	180883	325	181271	207	181553	493
180590	490	180893	325	181272	495	181554	483
180591	490	180905	326	181273	402	181555	483
180592	490	180945	316	181274	405	181556	483
180593	491	180949	316	181275	398	181557	480
180594	491	180950	317	181276	491	181558	480
180595	493	180953	317	181277	491	181559	481
180596	201	180954	317	181278	491	181561	484
180597	479	180959	317	181328	395	181562	206
180598	479	180963	317	181329	395	181563	420
180599	480	180985	317	181341	316	181564	495
180600	480	180986	317	181367	319	181565	496
180601	480	181001	322	181369	319	181566	496
180602	205	181005	322	181373	326	181567	496
180603	206	181008	322	181395	326	181568	496
180604	206	181009	322	181400	325	181569	496
180605	206	181015	322	181456	321	181570	441
180606	403	181021	322	181461	402	181571	442
180607	408	181034	322	181462	485	181572	442
180608	408	181064	323	181463	486	181573	442
180610	412	181065	323	181465	210	181574	442
180611	410	181073	323	181466	411	181575	399
180612	414	181076	323	181467	407	181576	406
180613	415	181077	323	181469	413	181577	207
180614	201	181088	323	181470	409	181578	204
180616	396	181089	324	181472	413	181579	400
180618	491	181121	324	181473	409	181581	418
180619	204	181126	324	181474	409	181582	406
180620	405	181147	319	181475	201	181583	418
180622	403	181148	319	181476	206	181584	311
180624	413	181150	320	181477	204	181585	311
180625	499	181152	320	181485	405	181586	311
180626	314	181156	320	181489	416	181587	312
180627	480	181158	320	181491	313	181588	312
180628	480	181179	320	181493	313	181589	312
180630	314	181182	320	181494	313	181590	312
180631	314	181183	320	181495	313	181591	312
180634	314	181191	321	181496	313	181592	312
180635	315	181194	321	181497	313	181594	396
180636	315	181197	321	181500	313	181595	210

ACCESSORIES

O. E. M. names and numbers are used for reference purposes only.

HC-CARGO	Page	HC-CARGO	Page	HC-CARGO	Page	HC-CARGO	Page
181596	210	181658	488	190057	425	190215	387
181597	210	181659	488	190058	425	190218	389
181598	209	181660	488	190059	425	190220	389
181599	201	181661	488	190060	425	190221	389
181600	415	181662	488	190061	425	190222	389
181601	399	181663	488	190093	528	190223	390
181602	401	181664	489	190094	528	190224	390
181603	205	181665	489	190095	528	190225	390
181604	405	181666	489	190096	528	190226	390
181605	395	181667	485	190097	189, 528	190228	390
181606	395	181668	485	190100	528	190229	390
181607	481	190001	337	190101	528	190230	390
181608	481	190002	430	190110	515	190231	391
181609	481	190004	430	190111	515	190232	391
181610	481	190005	531	190112	515	190235	391
181611	420	190006	531	190114	515	190237	391
181612	418	190007	531	190115	515	190239	391
181613	201	190008	531	190116	515	190242	391
181614	202	190009	531	190120	514	190248	505
181615	485	190010	531	190122	514	190252	340
181616	399	190011	505	190157	531	190253	389
181617	404	190012	384	190158	531	190254	389
181618	401	190013	384	190159	531	190255	337
181619	401	190014	506	190160	531	190256	341
181620	401	190015	337	190161	531	190257	337
181621	402	190016	336	190162	531	190259	378
181622	401	190017	336	190163	531	190260	351
181623	418	190018	336	190164	531	190261	351
181624	418	190019	336	190165	531	190262	352
181625	418	190020	336	190166	531	190263	353
181626	418	190021	336	190167	531	190264	353
181627	419, 87, 103	190022	336	190168	531	190265	354
181628	419	190023	336	190169	531	190266	354
181629	400	190024	336	190170	531	190267	354
181630	420	190025	336	190171	531	190268	354
181631	399	190026	336	190172	531	190269	355
181632	485	190027	337	190175	515	190270	339
181633	442	190028	337	190176	515	190272	352
181634	442	190029	337	190177	515	190273	432
181635	442	190030	337	190178	515	190274	424
181636	443	190031	337	190179	515	190275	424
181637	443	190032	337	190180	532	190276	424
181638	484	190033	337	190181	532	190277	424
181639	484	190034	337	190182	532	190278	424
181640	484	190035	337	190183	532	190279	424
181641	486	190037	337	190184	532	190280	424
181642	486	190038	337	190185	532	190283	345
181643	486	190039	337	190186	532	190284	424
181644	486	190041	336	190187	532	190285	424
181645	486	190042	337	190188	505	190286	424
181646	486	190043	379	190189	505	190287	424
181647	486	190045	336	190190	505	190288	424
181648	487	190046	336	190191	505	190289	424
181649	487	190048	336	190195	381	190360	576
181650	487	190049	336	190196	381	190361	576
181651	487	190050	336	190197	381	190362	576
181652	487	190051	336	190202	386	190366	576
181653	487	190052	345	190203	386	190367	576
181654	487	190053	425	190211	384	190368	576
181655	487	190054	425	190212	385	190371	576
181656	488	190055	425	190213	383	190372	576
181657	488	190056	425	190214	383	190373	576

HC-CARGO	Page	HC-CARGO	Page	HC-CARGO	Page	HC-CARGO	Page
190469	576	190599	586	190720	343	190907	504
190470	576	190603	586	190721	343	190908	504
190474	576	190604	586	190722	343	190909	504
190477	576	190605	586	190723	343	190910	519
190478	576	190606	586	190725	340	190911	381
190479	577	190608	587	190726	341	190937	531
190480	577	190609	587	190734	424	190938	531
190482	577	190610	587	190735	424	190948	521
190492	577	190612	587	190736	424	190950	522
190493	577	190613	587	190762	378	190951	519
190494	577	190614	587	190766	467	190952	337
190495	577	190616	587	190767	467	190953	337
190499	577	190632	587	190768	430	190954	521
190500	577	190633	587	190770	430	190956	379
190506	577	190634	587	190772	430	190957	433
190508	577	190638	587	190774	430	190958	515
190510	577	190660	588	190775	431	190959	515
190511	577	190666	522	190776	379	190961	504
190520	581	190667	522	190779	581	190962	504
190521	581	190674	518	190780	581	190964	514
190524	581	190675	521	190781	581	190965	514
190525	581	190676	522	190782	581	190966	514
190527	581	190677	519	190783	581	190967	514
190528	581	190677Z	519	190787	432	190968	514
190531	578	190678	519	190806	585	190969	514
190536	579	190680	523	190807	585	190970	514
190537	579	190681	523	190808	585	190971	380
190538	579	190682	523	190809	585	190972	519
190539	579	190683	523	190810	585	190973	337
190540	579	190684	523	190811	585	190974	337
190541	579	190685	521	190812	585	190979	522
190542	579	190686	522	190813	585	190981	522
190543	579	190687	522	190815	585	190984	528
190544	579	190688	522	190816	585	190985	336
190545	580	190689	522	190817	585	190986	518
190546	580	190690	522	190818	585	190987	518
190547	580	190691	522	190819	585	190988	518
190549	579	190693	522	190820	585	190989	518
190550	579	190695	527	190821	585	190990	518
190551	579	190696	518	190822	585	190991	518
190552	579	190697	518	190823	585	190992	518
190555	580	190697Z	518	190824	585	190993	522
190556	579	190698	518	190826	585	190994	527
190558	579	190699	518	190828	585	190995	527
190561	578	190700	519	190843	352	190996	527
190577	586	190701	519	190845	521	190997	527
190578	586	190702	519	190846	343	190998	528
190579	586	190703	519	190847	519	190999	528
190580	586	190703Z	519	190866	385	191000	528
190581	586	190704	519	190867	386	191001	433
190582	586	190704Z	519	190868	340	191002	521
190583	586	190705	519	190870	433	191003	505
190584	586	190706	519	190875	380	191007	349
190587	584	190707	519	190876	381	191008	340
190588	584	190708	519	190899	504	191009	338
190589	584	190709	522	190900	504	191010	338
190590	584	190710	521	190901	504	191011	338
190591	584	190711	522	190902	504	191012	433
190592	584	190716	343	190903	504	191013	526
190593	585	190717	343	190904	504	191014	527
190594	585	190718	343	190905	504	191015	527
190598	586	190719	343	190906	504	191016	345

ACCESSORIES

O. E. M. names and numbers are used for reference purposes only.

HC-CARGO	Page	HC-CARGO	Page	HC-CARGO	Page	HC-CARGO	Page
191025	341	191156	427	191226	351	191303	581
191026	467	191157	427	191227	350	191304	581
191027	519	191158	352	191228	505	191305	581
191028	339	191159	352	191229	505	191306	581
191029	340	191160	522	191230	505	191307	581
191030	343	191161	431	191232	505	191308	581
191043	522	191162	431	191233	505	191309	588
191044	345	191163	431	191234	505	191311	588
191047	345	191164	431	191235	505	191312	588
191048	345	191165	431	191236	505	191317	579
191049	343	191166	385	191237	532	191318	579
191050	343	191167	385	191238	526	191319	579
191051	343	191168	342	191239	531	191320	580
191053	438	191169	342	191244	386	191321	580
191054	434	191170	414	191245	386	191322	578
191055	439	191171	342	191246	340	191323	578
191056	531	191172	342	191247	340	191325	578
191058	522	191175	519	191248	340	191326	577
191060	343	191176	519	191249	426	191327	577
191062	522	191177	519	191250	426	191329	577
191063	528	191178	519	191251	426	191330	577
191064	340	191179	526	191252	426	191333	548
191065	532	191182	528	191253	426	191335	585
191067	337	191183	499	191254	426	191336	587
191069	341	191184	428	191255	426	191337	584
191070	354	191185	428	191256	426	191339	586
191071	354	191186	428	191257	436	191340	586
191074	341	191187	428	191258	439	191341	585
191075	341	191188	428	191259	439	191342	586
191076	380	191189	428	191260	340	191344	585
191077	380	191190	438	191261	341	191345	586
191078	341	191191	336	191262	341	191346	585
191079	341	191192	529	191263	345	191347	586
191080	350	191193	529	191264	345	191348	586
191081	350	191195	526	191265	587	191349	586
191082	341	191196	342	191266	578	191350	586
191083	340	191197	342	191267	579	191351	585
191086	521	191200	340	191270	548	191352	585
191087	521	191201	526	191271	548	191353	586
191088	526	191202	500	191272	548	191354	586
191089	340	191203	500	191273	548	191355	586
191090	518	191204	500	191274	548	191356	586
191091	341	191205	500	191275	548	191357	586
191092	341	191206	500	191276	548	191358	585
191093	521	191207	500	191277	548	191364	544
191094	505	191208	500	191278	548	191365	544
191095	522	191209	501	191279	548	191366	544
191126	351	191210	501	191280	548	191367	544
191127	350	191211	501	191284	588	191368	544
191128	505	191212	503	191285	588	191369	544
191129	339	191213	503	191287	586	191370	544
191130	522	191214	503	191288	586	191371	544
191131	522	191215	501	191289	586	191372	544
191132	523	191216	501	191290	584	191373	544
191133	383	191218	503	191291	586	191374	544
191134	383	191219	503	191293	576	191375	544
191135	522	191220	502	191294	577	191376	544
191136	522	191221	502	191296	581	191377	532
191152	426	191222	503	191297	581	191378	532
191153	426	191223	503	191298	581	191379	536
191154	426	191224	353	191299	581	191380	515
191155	427	191225	353	191302	581	191383	515

HC-CARGO	Page	HC-CARGO	Page	HC-CARGO	Page	HC-CARGO	Page
191384	515	191473	425	191554	579	191646	586
191387	515	191474	425	191556	341	191648	586
191388	515	191475	425	191557	580	191649	588
191390	545	191476	425	191558	579	191650	351
191391	545	191477	581	191560	585	191657	581
191392	545	191478	579	191561	355	191658	580
191395	518	191480	544	191562	355	191659	580
191396	518	191481	548	191563	341	191660	580
191396Z	518	191484	380	191564	341	191661	580
191397	518	191485	380	191565	544	191664	425
191398	518	191486	580	191567	544	191666	504
191399	518	191487	585	191570	424	191667	504
191400	518	191489	585	191571	424	191668	504
191401	518	191490	585	191572	424	191669	504
191402	518	191491	585	191573	548	191671	424
191403	518	191494	515	191574	522	191672	427
191404	518	191495	526	191575	587	191673	427
191405	378	191498	381	191576	587	191675	544
191406	378	191499	527	191577	587	191677	580
191407	379	191501	337	191578	586	191678	578
191408	379	191502	584	191579	586	191679	391
191409	431	191503	585	191580	582	191680	434
191410	468	191504	585	191582	579	191681	339
191411	342	191505	580	191584	579	191682	338
191412	342	191506	584	191585	579	191683	338
191413	342	191507	501	191586	578	191684	338
191415	339	191508	502	191587	587	191685	338
191416	343	191510	502	191592	531	191686	338
191417	504	191513	581	191593	531	191687	338
191418	522	191514	577	191594	531	191688	338
191419	522	191515	337	191595	531	191689	338
191429	501	191516	523	191596	531	191690	338
191430	586	191517	523	191597	531	191691	338
191432	581	191518	523	191613	580	191692	338
191433	548	191519	523	191614	580	191693	338
191434	586	191520	523	191615	576	191694	338
191435	578	191521	523	191616	545	191695	338
191439	581	191522	523	191617	522	191696	337
191440	588	191523	523	191618	522	191697	338
191441	588	191524	523	191619	522	191698	338
191442	586	191525	524	191620	521	191699	338
191443	536	191526	524	191621	521	191700	338
191445	523	191527	524	191623	521	191701	338
191446	523	191528	579	191624	579	191702	338
191447	523	191530	579	191625	582	191703	338
191448	523	191531	579	191626	582	191704	339
191449	523	191532	586	191628	427	191705	339
191450	523	191533	578	191629	427	191706	339
191451	522	191534	424	191630	427	191707	339
191452	522	191535	522	191631	427	191708	339
191453	522	191536	577	191632	427	191709	339
191457	585	191538	585	191633	427	191710	339
191458	588	191539	580	191634	427	191711	339
191459	588	191543	341	191635	427	191713	339
191465	425	191544	341	191636	427	191717	475
191466	425	191545	578	191637	427	191718	475
191467	425	191546	578	191638	426	191719	475
191468	425	191548	585	191640	434	191721	475
191469	425	191549	339	191642	544	191722	476
191470	425	191551	340	191643	578	191723	476
191471	425	191552	588	191644	576	191724	476
191472	425	191553	504	191645	577	191725	476

ACCESSORIES

O. E. M. names and numbers are used for reference purposes only.

HC-CARGO	Page	HC-CARGO	Page	HC-CARGO	Page	HC-CARGO	Page
191726	476	191815	585	191940	506	192013	506
191727	477	191816	548	191941	506	192014	506
191728	478	191817	522	191942	506	192015	506
191729	478	191818	468	191943	506	192036	336
191730	478	191820	388	191944	513	192041	505
191731	478	191821	388	191945	513	192046	579
191732	478	191830	427	191946	513	192047	345
191733	342	191831	427	191947	513	192048	588
191734	342	191832	427	191948	513	192049	426
191735	343	191833	427	191949	513	192050	426
191737	343	191834	427	191950	505	192051	426
191738	343	191854	577	191951	505	192052	426
191739	343	191855	342	191952	505	192053	426
191740	343	191856	343	191953	505	192054	531
191741	477	191857	544	191954	505	192055	437
191742	477	191858	544	191955	505	192057	432
191743	477	191859	544	191956	505	192058	432
191744	477	191860	544	191957	505	192060	580
191745	478	191861	544	191958	505	192062	585
191746	478	191862	544	191959	505	192063	577
191751	350	191863	544	191960	507	192065	579
191752	467	191864	544	191962	345	192068	505
191753	576	191865	544	191963	345	192071	577
191754	581	191866	544	191964	345	192072	582
191755	502	191867	578	191965	345	192073	580
191756	381, 504	191868	585	191966	345	192074	389
191760	424	191869	586	191967	345	192075	388
191762	579	191870	342	191968	345	192076	388
191763	578	191871	342	191969	345	192077	370
191764	343	191872	342	191970	426	192078	370
191765	343	191873	579	191971	427	192079	370
191766	343	191881	515	191972	427	192080	370
191767	477	191882	515	191973	427	192081	370
191768	433	191883	515	191974	427	192082	371
191769	433	191884	344	191975	427	192083	371
191770	578	191885	344	191976	427	192084	371
191771	382, 504	191886	344	191977	427	192085	371
191772	577	191887	344	191978	427	192086	371
191774	434	191888	344	191983	345	192087	371
191775	434	191889	344	191984	502	192088	372
191776	505	191890	344	191985	341	192089	339
191777	521	191891	344	191987	578	192090	339
191789	576	191898	581	191988	576	192091	347
191790	580	191899	579	191989	386	192093	521
191791	345	191900	577	191990	387	192096	521
191793	524	191901	585	191991	504	192099	521
191794	524	191903	587	191992	504	192102	522
191795	524	191904	424	191994	504	192103	522
191796	524	191913	587	191996	504	192104	522
191798	576	191914	548	191997	504	192105	427
191799	548	191915	341	191998	504	192106	427
191801	342	191916	341	192001	340	192107	427
191804	577	191918	353	192002	351	192108	427
191805	527	191923	521	192003	343	192109	427
191806	340	191924	521	192004	343	192110	505
191807	339	191927	521	192005	343	192111	505
191808	352	191928	521	192006	576	192112	505
191809	352	191930	518	192007	344	192114	576
191810	353	191936	518	192008	344	192122	575
191811	353	191937	350	192009	513	192123	575
191813	586	191938	341	192010	513	192124	585
191814	504	191939	505	192012	506	192127	581

HC-CARGO	Page	HC-CARGO	Page	HC-CARGO	Page	HC-CARGO	Page
192128	586	192214	526	192295	525	192366	532
192131	544	192215	526	192296	525	192367	585
192132	436	192216	579	192298	429	192368	382
192133	439	192217	339	192299	429	192369	382
192134	343	192218	502	192300	429	192370	337
192135	343	192222	345	192301	429	192371	337
192136	436	192224	345	192302	429	192372	580
192137	436	192225	345	192303	429	192373	339
192138	514	192226	336	192304	429	192374	340
192139	514	192227	521	192305	429	192375	347
192140	340	192228	581	192306	429	192376	340
192142	337	192229	426	192307	429	192377	340
192143	581	192230	426	192308	429	192379	533
192144	548	192231	426	192309	429	192380	339
192145	579	192234	388	192310	429	192381	340
192146	372	192236	341	192311	429	192383	341
192147	373	192237	341	192312	429	192384	526
192148	373	192239	339	192313	429	192385	526
192149	372	192240	339	192314	429	192386	508
192150	374	192242	345	192315	429	192387	508
192151	374	192245	585	192316	429	192388	508
192152	374	192247	577	192317	429	192389	508
192153	375	192248	577	192318	429	192390	508
192154	375	192249	577	192319	429	192391	509
192155	340	192250	577	192320	429	192398	509
192156	339	192251	577	192321	429	192399	509
192157	339	192252	577	192322	429	192400	382
192158	467	192253	577	192323	429	192401	382
192159	467	192254	578	192324	429	192402	383
192160	468	192255	576	192325	429	192403	383
192161	468	192256	577	192326	429	192404	576
192163	384	192259	519	192327	429	192405	580
192164	384	192260	519	192328	429	192407	577
192165	425	192261	519	192329	429	192410	339
192166	372	192262	519	192330	429	192411	340
192167	373	192263	519	192331	429	192413	578
192171	374	192264	519	192332	429	192414	580
192172	374	192265	519	192333	429	192416	578
192173	374	192267	519	192334	429	192417	582
192174	339	192269	519	192335	429	192418	576
192175	340	192270	519	192336	429	192419	440
192176	340	192271	519	192337	429	192420	440
192177	347	192272	519	192338	428	192421	436
192178	347	192273	519	192344	438	192422	437
192179	347	192274	519	192345	438	192423	437
192180	342	192275	518	192346	555	192424	439
192181	342	192276	518	192347	578	192425	578
192190	510	192277	518	192348	586	192427	426
192191	510	192278	518	192352	337	192428	426
192192	510	192279	518	192353	337	192429	426
192196	507	192280	518	192354	337	192430	426
192197	507	192282	518	192355	513	192431	426
192204	509	192283	518	192356	513	192432	426
192205	509	192284	518	192357	513	192433	426
192206	524	192286	518	192358	513	192434	426
192207	524	192287	518	192359	513	192435	426
192208	524	192288	518	192360	514	192436	437
192209	524	192289	519	192361	527	192438	585
192210	525	192291	523	192362	584	192440	580
192211	525	192292	523	192363	585	192441	580
192212	525	192293	508	192364	580	192442	350
192213	525	192294	508	192365	576	192443	340

ACCESSORIES

O. E. M. names and numbers are used for reference purposes only.

HC-CARGO	Page	HC-CARGO	Page	HC-CARGO	Page	HC-CARGO	Page
192444	579	192532	578	192610	362	192721	424
192445	523	192533	425	192611	363	192722	526
192446	522	192536	578	192612	363	192723	526
192447	576	192538	428	192613	364	192724	526
192449	336	192539	428	192614	364	192725	581
192450	360	192540	428	192615	365	192727	581
192451	360	192541	428	192616	365	192750	581
192452	360	192542	428	192617	366	192751	548
192453	360	192543	428	192618	366	192752	577
192457	356	192544	428	192619	342	192753	576
192458	356	192545	428	192620	342	192754	580
192459	357	192546	428	192621	342	192755	532
192460	357	192547	428	192622	342	192756	544
192461	357	192548	428	192625	516	192758	342
192462	358	192549	428	192631	434	192759	435
192463	358	192550	578	192632	434	192760	427
192464	358	192551	578	192633	435	192762	425
192465	359	192552	342	192634	435	192763	425
192466	359	192554	576	192635	435	192764	425
192467	356	192555	522	192636	435	192765	425
192468	356	192557	343	192637	435	192766	425
192469	357	192558	576	192638	439	192767	425
192470	357	192559	510	192639	439	192768	425
192471	358	192560	510	192645	339	192769	425
192472	358	192563	578	192646	339	192770	425
192473	359	192564	578	192647	348	192771	425
192474	359	192565	578	192648	380	192772	340
192475	359	192566	578	192651	369	192773	545
192476	360	192567	578	192652	369	192778	576
192477	342	192568	578	192655	369	192779	428
192478	342	192569	579	192656	369	192780	428
192479	514	192571	579	192658	527	192781	428
192480	514	192572	579	192659	510	192782	428
192481	514	192573	340	192660	510	192783	428
192482	514	192574	340	192663	585	192784	428
192483	514	192575	341	192667	584	192786	339
192484	432	192576	345	192671	580	192787	361
192485	341	192578	555, 587	192672	580	192788	366
192486	341	192582	526	192676	579	192789	522
192488	355	192583	526	192678	586	192790	580
192489	507	192585	585	192679	586	192791	426
192491	580	192586	579	192681	387	192792	426
192493	384	192587	347	192682	387	192793	426
192494	506	192588	576	192683	370	192794	436
192495	506	192591	580	192685	432	192795	336
192496	506	192592	580	192686	432	192797	433
192497	506	192594	580	192687	437	192798	426
192498	506	192595	361	192689	588	192799	426
192501	355	192596	361	192694	586	192800	426
192502	373	192597	362	192695	584	192801	426
192503	339	192598	362	192696	584	192802	426
192505	342	192599	363	192697	586	192803	426
192506	342	192600	363	192700	511	192804	426
192507	548	192601	364	192701	511	192805	426
192508	576	192602	364	192702	511	192808	348
192511	577	192603	364	192703	511	192809	348
192513	515	192604	365	192704	579	192810	348
192515	580	192605	365	192705	428	192811	348
192524	548	192606	365	192706	578	192812	348
192528	339	192607	361	192707	548	192813	349
192529	339	192608	361	192718	585	192814	548
192531	555	192609	362	192720	528	192817	532

HC-CARGO	Page	HC-CARGO	Page	HC-CARGO	Page	HC-CARGO	Page
192818	532	192936	443	193007	516	193070	520
192819	532	192937	443	193008	516	193071	520
192820	521	192938	443	193009	516	193072	520
192821	585	192939	443	193010	355	193073	520
192822	578	192940	443	193011	382, 504	193074	520
192825	336	192941	443	193012	519	193075	520
192828	349	192942	443	193013	519	193076	520
192829	349	192943	443	193014	520	193077	520
192830	349	192944	443	193015	520	193078	520
192831	349	192945	443	193016	437	193079	520
192832	349	192947	443	193017	366	193080	520
192833	349	192948	443	193018	366	193081	520
192836	527	192949	443	193019	367	193082	520
192837	527	192950	337	193020	367	193083	520
192838	527	192951	522	193021	367	193084	520
192840	527	192952	438	193022	367	193085	520
192844	525	192953	443	193023	368	193086	520
192859	348	192954	443	193024	358	193087	520
192861	429	192955	444	193025	585	193088	521
192862	429	192956	444	193027	531	193089	521
192863	429	192957	444	193028	531	193090	521
192864	438	192958	446	193029	531	193091	356
192871	378	192959	444	193030	531	193092	356
192881	523	192960	444	193031	531	193093	357
192882	523	192961	444	193032	531	193094	357
192884	372	192962	445	193033	531	193095	358
192888	387	192963	445	193034	531	193097	359
192889	387	192964	445	193035	531	193098	359
192890	388	192965	446	193036	531	193099	360
192891	388	192966	445	193037	531	193100	360
192902	372	192967	445	193038	531	193101	361
192903	509	192968	445	193039	531	193102	361
192904	509	192969	446	193040	531	193103	362
192905	344	192970	446	193041	531	193104	362
192906	344	192971	446	193042	368	193105	362
192907	344	192972	446	193043	368	193106	363
192908	344	192973	446	193044	369	193107	363
192909	344	192974	447	193045	369	193108	363
192910	344	192975	343	193046	505	193109	364
192911	344	192976	426	193047	520	193110	364
192912	344	192977	426	193048	520	193111	365
192913	344	192978	426	193049	520	193112	365
192914	344	192979	426	193050	520	193113	366
192915	344	192980	426	193051	520	193114	366
192916	344	192981	427	193052	520	193115	367
192917	344	192982	427	193053	520	193116	367
192918	344	192983	507	193054	520	193117	368
192919	344	192984	580	193055	520	193118	368
192920	344	192985	507	193056	520	193119	73
192921	344	192986	340	193057	520	193120	342
192922	344	192987	368	193058	520	193121	512
192923	344	192988	544	193059	520	193122	512
192924	344	192997	507	193060	520	193123	512
192925	344	192998	340	193061	520	193124	512
192926	344	192999	443	193062	520	193125	512
192927	344	193000	385	193063	520	193126	512
192928	344	193001	385	193064	520	193127	512
192929	338	193002	420	193065	520	193128	512
192930	338	193003	516	193066	520	193129	512
192931	338	193004	516	193067	520	193130	512
192932	344	193005	516	193068	520	193131	512
192933	344	193006	516	193069	520	193132	512

ACCESSORIES

O. E. M. names and numbers are used for reference purposes only.

HC-CARGO	Page	HC-CARGO	Page	HC-CARGO	Page	HC-CARGO	Page
193133	512	193195	516	200589	588	200737	538
193134	512	193196	516	200601	538	200738	539
193135	512	193197	516	200603	553	200739	539
193136	512	193198	516	200618	537	200740	539
193137	512	193199	516	200621	553	200741	539
193138	512	193200	516	200622	553	200742	539
193139	512	193201	516	200624	554	200744	537
193140	512	193202	516	200633	588	200745	537
193141	512	193203	516	200635	144	200746	536
193142	512	193204	516	200640	553	200747	538
193143	512	193205	516	200641	533	200748	537
193144	512	193206	516	200642	533	200749	537
193145	512	193207	516	200649	534	200760	534
193146	512	193208	516	200650	536	200765	542
193147	512	193209	516	200652	534	200766	542
193148	512	193210	516	200654	533	200768	543
193149	512	193211	516	200655	554	200769	543
193150	512	193212	512	200659	145	200771	543
193151	512	193213	425	200663	172, 330, 590	200772	541
193152	512	193214	425	200664	172, 331, 591	200773	541
193153	512	193215	425	200665	173, 331, 591	200774	541
193154	512	193216	425	200666	173, 331, 591	200775	541
193155	512	193217	425	200667	173, 331, 591	200776	540
193156	512	193218	425	200668	173, 331, 591	200777	540
193157	512	193219	425	200669	173, 331, 591	200778	541
193158	512	193220	532	200670	173, 332, 592	200779	541
193159	512	193221	532	200671	174, 332, 592	200780	534
193160	512	193222	532	200672	174, 332, 592	200787	553
193161	512	193223	532	200673	174, 332, 592	200789	535
193162	512	193224	532	200676	174, 332, 592	200790	550
193163	512	193225	532	200684	146	200791	540
193164	512	193226	532	200685	554	200792	539
193165	512	193227	532	200686	553	200796	538
193166	387	193228	532	200687	554	200802	541
193167	387	193230	532	200688	554	200805	553
193168	344	193231	532	200693	174, 332	200808	539
193169	515	193232	532	200697	534	200810	536
193170	515	193233	342	200698	555	200812	540
193171	515	193234	342	200699	555	200813	542
193172	515	193235	342	200700	555	200828	540
193173	515	193236	342	200701	555	200831	553
193174	515	193237	338	200703	555	200832	553
193175	515	193239	511	200704	555	200833	553
193176	515	193240	511	200706	555	200834	553
193177	515	193241	373	200707	555	200837	145
193178	515	200004	533	200708	555	200838	550
193179	515	200005	533	200709	555	200846	542
193180	515	200027	533	200710	555	200848	540
193181	516	200028	534	200711	555	200850	550
193182	516	200094	535	200712	555	200851	543
193183	516	200127	554	200713	555	200852	543
193184	516	200140	553	200720	550	200853	543
193185	516	200141	553	200721	536	200854	542
193186	516	200142	553	200722	536	200858	542
193187	516	200144	554	200723	536	200866	554
193188	516	200181	144	200724	536	200867	554
193189	516	200300	535	200726	533	200868	554
193190	516	200400	535	200728	145	200869	554
193191	516	200500	535	200733	145	200875	172, 330, 590
193192	516	200526	553	200734	536	200876	172, 330, 590
193193	516	200527	553	200735	538	200877	172, 330, 590
193194	516	200588	588	200736	538	200878	172, 330, 590

HC-CARGO	Page	HC-CARGO	Page	HC-CARGO	Page	HC-CARGO	Page
200879	174, 330, 590	210699	566	210827	517	211052	377
200884	553	210708	573	210828	517	211053	377
200885	553	210709	573	210843	556	211058	566
200886	553	210710	573	210845	568	211059	565
200887	553	210712	574	210846	569	211065	567
200889	553	210713	574	210849	517	211073	570
200890	553	210715	574	210851	375	211077	570
200891	553	210716	574	210853	574	211080	567
200892	553	210718	574	210855	573	211081	557
200893	553	210720	574	210859	574	211083	571
200897	553	210722	574	210860	574	211090	551
200898	542	210723	574	210867	559	211091	573
210050	556	210724	574	210868	559	211092	552
210051	556	210725	574	210869	565	211094	571
210052	564	210726	574	210871	565	211096	516
210053	564	210727	574	210872	565	211097	572
210054	565	210728	574	210873	556	211101	567
210121	345	210729	574	210877	556	211102	567
210134	564	210740	574	210878	568	211103	571
210140	549	210741	575	210897	550	211106	551
210141	549	210742	575	210898	550	211107	552
210142	549	210743	575	210899	551	211108	552
210143	549	210744	574	210901	551	211109	552
210144	549	210745	575	210902	551	211110	552
210145	549	210747	575	210903	551	211113	566
210146	549	210748	575	210904	552	211114	566
210147	549	210749	573	210905	575	211115	574
210148	549	210750	574	210909	556	211117	572
210149	549	210751	574	210910	551	211118	573
210150	549	210752	575	210911	552	211119	572
210151	549	210753	575	210912	552	211120	377
210152	549	210754	575	210918	376	211122	572
210153	549	210755	575	210919	376	211123	484, 572
210154	549	210757	575	210921	376	211124	571
210155	549	210758	565	210936	555	211126	568
210156	549	210759	574	210937	346	211127	377
210157	549	210760	346	210938	346	211128	568
210158	549	210762	566	210939	346	230858	548
210159	549	210763	557	210948	557	253488	554
210160	549	210771	564	210973	347	253489	144
210164	549	210777	558	210977	567	253504	144
210212	571	210778	558	210980	567	4440X	55
210212Z	571	210779	558	210995	560	804008	593
210249	556	210780	558	210996	560	804012	593
210566	559	210781	558	211013	568	804014	593
210567	559	210782	558	211014	568	804015	593
210574	592	210786	559	211017	377	804017	594
210638	345	210788	558	211018	377	804020	594
210639	346	210789	555	211027	573	804021	594
210643	375	210790	555	211028	573	804022	594
210644	517	210791	555	211030	376	804024	595
210645	517	210793	555	211035	569	804028	595
210649	569	210794	555	211036	570	804032	595
210661	375	210809	555	211039	570	804036	595
210667	375	210812	555	211040	570	804037	596
210672	376	210813	555	211041	570	804040	596
210675	376	210814	555	211042	571	804041	596
210686	559	210816	555	211044	569	804048	596
210689	346	210817	555	211045	569	804049	597
210691	549	210818	555	211048	557	804050	597
210692	549	210820	555	211049	557	804052	597
210696	346	210822	555	211051	377	804054	597

ACCESSORIES

O. E. M. names and numbers are used for reference purposes only.

HC-CARGO	Page	HC-CARGO	Page	HC-CARGO	Page	HC-CARGO	Page
804055	598	B090078	529	B192292	523		
804056	598	B090079	529	B192446	522		
804064	598	B090080	529	B192519	577		
804065	598	B090081	529	B192520	577		
804068	599	B090083	529	B192521	578		
804069	599	B090084	529	B192569	578		
804070	599	B090119	529	B192572	579		
804073	599	B090148	529	B192881	523		
804075	600	B190680	523	B230731	579		
804076	600	B190681	523	H4360	55		
804077	600	B190682	523	H5360	55		
804078	600	B190683	523	RT1000	242		
804079	601	B190684	523	RT1003	242		
804080	601	B191132	523	RT1005	243		
804081	601	B191306	581	RT2002	243		
804085	601	B191307	581	RT2005	253		
804086	602	B191308	581	RT2006	243		
804088	602	B191325	578	RT2016	243		
804089	602	B191326	577				
804090	602	B191327	577				
804091	603	B191328	577				
804092	603	B191329	577				
804093	603	B191330	577				
804094	603	B191380	515				
804095	604	B191382	515				
804096	604	B191383	515				
804097	604	B191384	515				
804098	604	B191385	515				
804099	605	B191386	515				
804100	605	B191387	515				
804101	605	B191446	523				
804102	605	B191447	523				
804104	606	B191448	523				
804105	606	B191449	523				
804106	606	B191450	523				
804107	606	B191451	522				
804109	607	B191452	522				
804110	607	B191453	522				
804111	607	B191478	579				
804113	607	B191494	515				
804117	608	B191513	581				
806011	333, 608	B191514	578				
806015	333, 608	B191523	523				
806020	333, 608	B191525	523				
806030	333	B191526	523				
806032	609	B191533	578				
806033	609	B191574	522				
807002	609	B191582	579				
808014	609	B191643	578				
808015	610	B191651	577				
809001	175	B191792	578				
809002	175	B191867	578				
809003	175	B191944	513				
809004	175	B191945	513				
809005	176	B191946	513				
809006	176	B191947	513				
809007	176	B191948	513				
809008	176	B191949	513				
809009	177	B192009	513				
811001	610	B192010	513				
811004	610	B192093	521				
AS301	242	B192291	523				

HC-CARGO Always Online

The products you require are only a few clicks away!



HC-CARGO is represented in 50 countries.
Please find more on www.hc-cargo.com
or call +45 76 14 33 00

DENMARK

Tel. 76 14 33 22 · Fax 76 14 32 30
sales.dk@hc-cargo.com

GERMANY

Tel. 02739 403040 · Fax 02739 4030420
cargo@cargo-de.com

AUSTRIA

Tel. 0810 202105 · Fax 0810 202106
cargo@cargo-de.com

UNITED KINGDOM

Tel. 0115 928 0086 · Fax 0115 928 0033
cargo@cargo-uk.com

BENELUX

NETHERLANDS Tel. 076 5019700
BELGIUM Tel. 03-6053128
Fax 0031 (0) 76 5019007
cargo@cargo-nl.com

SWEDEN

Tel. 019-27 88 00 · Fax 019 -27 88 70
cargo@cargo-se.com

FRANCE

Tel. 02 38 49 66 66 · Fax 02 38 49 66 67
cargo@cargo-fr.com

ITALY

Tel. 051 499 8989 · Fax 051 499 8990
cargo@hccargo-it.com

POLAND

Tel. 61 8400940
cargo@cargo-pl.com

USA

Tel. +1-404-346-6905 · Toll free +1-800-303-3170
Fax +1-770-236-0310
customerhelp@us.bosch.com cargo@cargo-us.com

All Other Countries

Tel. + 45 76 14 33 00 · Fax + 45 76 14 33 33
hc-cargo@hc-cargo.com

Your HC-CARGO contact:

11325



For your nearest HC-CARGO dealer
and full program overview visit
www.hc-cargo.com



Your Expert in Parts